

## VITA II

Quick Reference Guide  
Central Europe





**Carl Valentin GmbH**

Postfach 3744  
78026 Villingen-Schwenningen  
Neckarstraße 78 – 86 u. 94  
78056 Villingen-Schwenningen

Phone +49 7720 9712-0  
Fax +49 7720 9712-9901

E-Mail [info@carl-valentin.de](mailto:info@carl-valentin.de)  
Internet [www.carl-valentin.de](http://www.carl-valentin.de)

DE - DEUTSCH	5
ES - ESPAÑOL	33
FR - FRANÇAIS	61
GB - ENGLISH	89
IT - ITALIANO	117
PT - PORTUGUESE	145
TR - TÜRKÇE	173



Kurzanleitung und Hinweise zur  
Produktsicherheit

Deutsch

Copyright by Carl Valentin GmbH.

Angaben zu Lieferumfang, Aussehen, Leistung, Maßen und Gewicht entsprechen unseren Kenntnissen zum Zeitpunkt der Drucklegung.

Änderungen sind vorbehalten.

Kein Teil des Werks darf in irgendeiner Form (Druck, Fotokopie oder einem anderen Verfahren) ohne schriftliche Genehmigung der Carl Valentin GmbH reproduziert oder unter Verwendung elektronischer Systeme verarbeitet, vervielfältigt oder verbreitet werden.

Durch die ständige Weiterentwicklung der Geräte können evtl. Abweichungen zwischen der Dokumentation und dem Gerät auftreten. Die aktuelle Version ist unter [www.carl-valentin.de](http://www.carl-valentin.de) zu finden.

### Warenzeichen

Alle genannten Marken oder Warenzeichen sind eingetragene Marken oder eingetragene Warenzeichen ihrer jeweiligen Eigentümer und ggf. nicht gesondert gekennzeichnet. Aus dem Fehlen der Kennzeichnung kann nicht geschlossen werden, dass es sich nicht um eine eingetragene Marke oder ein eingetragenes Warenzeichen handelt.

Etikettendrucker der Carl Valentin GmbH erfüllen folgende Sicherheitsrichtlinien:

- CE** Niederspannungsrichtlinie (2014/35/EU)
- Richtlinie Elektromagnetische Verträglichkeit (2014/30/EU)



### Carl Valentin GmbH

Postfach 3744  
78026 Villingen-Schwenningen  
Neckarstraße 78 – 86 u. 94  
78056 Villingen-Schwenningen

Phone +49 7720 9712-0  
Fax +49 7720 9712-9901

E-Mail [info@carl-valentin.de](mailto:info@carl-valentin.de)  
Internet [www.carl-valentin.de](http://www.carl-valentin.de)

---

## Inhalt

Bestimmungsgemäße Verwendung	8
Sicherheitshinweise	8
Umweltgerechte Entsorgung	8
Betriebsbedingungen	9
Auspacken des Etikettendruckers	12
Lieferumfang	12
Aufstellen des Etikettendruckers	12
Anschließen des Etikettendruckers	12
Inbetriebnahme des Etikettendruckers	12
Etikettenrolle im Abreißmodus einlegen	13
Transferband einlegen	14
Print Settings (Druck Initialisierung)	15
Label Layout (Etikettenlayout)	15
Device Settings (Geräteparameter)	16
Network (Netzwerk)	18
Password (Passwort)	18
Interface (Schnittstellen)	19
Emulation (Emulation)	19
Date & Time (Datum & Uhrzeit)	20
Service Functions (Service Funktionen)	21
Main Menu (Grundmenü)	23
Compact Flash Card	24
Technische Daten	28
Transferband-Zugwalze reinigen	30
Andruckwalze reinigen	31
Druckkopf reinigen	31
Etikettenlichtschranke reinigen	31

## Bestimmungsgemäße Verwendung

- Der Etikettendrucker ist nach dem Stand der Technik und den anerkannten sicherheitstechnischen Regeln gebaut. Es kann dennoch bei der Verwendung Gefahr für Leib und Leben des Benutzers oder Dritter bzw. Beeinträchtigungen des Etikettendruckers und anderer Sachwerte entstehen.
- Der Etikettendrucker darf nur in technisch einwandfreiem Zustand sowie bestimmungsgemäß, sicherheits- und gefahrenbewusst unter Beachtung der Bedienungsanleitung benutzt werden. Insbesondere Störungen, die die Sicherheit beeinträchtigen, müssen umgehend beseitigt werden.
- Der Etikettendrucker ist ausschließlich zum Bedrucken von geeigneten und vom Hersteller zugelassenen Materialien bestimmt. Eine andersartige oder darüberhinausgehende Benutzung ist nicht bestimmungsgemäß. Für aus missbräuchlicher Verwendung resultierende Schäden haftet der Hersteller nicht - das Risiko trägt alleine der Anwender.
- Zur bestimmungsgemäßen Verwendung gehört auch das Beachten der Betriebsanleitung, einschließlich der vom Hersteller gegebenen Wartungsempfehlungen/-vorschriften.

## Sicherheitshinweise

- Der Etikettendrucker ist für Stromnetze mit Wechselspannung von 110 ... 230 V AC ausgelegt. Etikettendrucker nur an Steckdosen mit Schutzleiterkontakt anschließen.
- Der Etikettendrucker ist nur mit Geräten zu verbinden, die Schutzkleinspannung führen.
- Vor dem Herstellen oder Lösen von Anschlüssen alle betroffenen Geräte (Computer, Drucker, Zubehör) ausschalten.
- Der Etikettendrucker darf nur in einer trockenen Umgebung betrieben und keiner Nässe (Spritzwasser, Nebel, etc.) ausgesetzt werden.
- Wartungs- und Instandhaltungsmaßnahmen dürfen nur von geschultem Fachpersonal durchgeführt werden.
- Bedienpersonal muss durch den Betreiber anhand der Betriebsanleitung unterwiesen werden.
- Wird der Etikettendrucker bei geöffnetem Deckel betrieben, ist darauf zu achten, dass Kleidung, Haare, Schmuckstücke oder ähnliches von Personen nicht mit den offen liegenden, rotierenden Teilen in Berührung kommen.
- Das Gerät und Teile (z.B. Druckkopf) davon können während des Drucks heiß werden. Während des Betriebs nicht berühren und vor Materialwechsel, Ausbauen oder Justieren abkühlen lassen.
- Niemals leicht brennbares Verbrauchsmaterial verwenden.
- Es besteht eine Verletzungsgefahr an der Abreißkante. Falls die Abreißkante nicht verwendet wird, Kantenschutzprofil anbringen.
- Nur die in der Bedienungsanleitung beschriebenen Handlungen dürfen ausgeführt werden. Arbeiten die darüber hinausgehen dürfen nur vom Hersteller oder in Abstimmung mit dem Hersteller durchgeführt werden.
- Unsachgemäße Eingriffe an elektronischen Baugruppen und deren Software können Störungen verursachen.
- Unsachgemäße Arbeiten oder andere Veränderungen am Gerät können die Betriebssicherheit gefährden.
- Servicearbeiten immer in einer qualifizierten Werkstatt durchführen lassen, die die notwendigen Fachkenntnisse und Werkzeug zur Durchführung der erforderlichen Arbeit besitzt.
- An den Geräten sind Warnhinweis-Etiketten angebracht. Keine Warnhinweis-Etiketten entfernen sonst können Gefahren nicht erkannt werden.



### GEFAHR!

Lebensgefahr durch Netzspannung!  
⇒ Gehäuse des Geräts nicht öffnen.



### HINWEIS!

Für Norwegen und Schweden

Geräte, die über einen Netzanschluss mit einer Verbindung zur Schutzerdung an die Schutzerdung der elektrischen Anlage des Gebäudes und an ein Kabelverteilsystem mit Koaxialkabeln angeschlossen sind, können unter bestimmten Umständen Brandgefahren verursachen. Die Verbindung mit einem Kabelverteilsystem muss daher über eine Einrichtung erfolgen, die eine elektrische Isolierung unterhalb eines bestimmten Frequenzbereichs bereitstellt.

## Umweltgerechte Entsorgung

Hersteller von B2B-Geräten sind seit 23.03.2006 verpflichtet Altgeräte, die nach dem 13.08.2005 hergestellt wurden, zurückzunehmen und zu verwerten. Diese Altgeräte dürfen grundsätzlich nicht an kommunalen Sammelstellen abgegeben werden. Sie dürfen nur vom Hersteller organisiert verwertet und entsorgt werden. Entsprechend gekennzeichnete Valentin Produkte können daher zukünftig an Carl Valentin GmbH zurückgegeben werden.

Die Altgeräte werden daraufhin fachgerecht entsorgt.

Die Carl Valentin GmbH nimmt dadurch alle Verpflichtungen im Rahmen der Altgeräteentsorgung rechtzeitig wahr und ermöglicht damit auch weiterhin den reibungslosen Vertrieb der Produkte. Wir können nur frachtfrei zugesandte Geräte zurücknehmen.

Die Elektronikplatine des Drucksystems ist mit einer Lithium Batterie ausgestattet. Diese ist in Altbatteriesammelgefäßen des Handels oder bei den öffentlich-rechtlichen Entsorgungsträgern zu entsorgen.

Weitere Informationen finden Sie in der WEEE Richtlinie oder auf unserer Internetseite [www.carl-valentin.de](http://www.carl-valentin.de).



## Betriebsbedingungen

Die Betriebsbedingungen sind Voraussetzungen, die vor Inbetriebnahme und während des Betriebs unserer Geräte erfüllt sein müssen, um einen sicheren und störungsfreien Betrieb zu gewährleisten.

Bitte lesen Sie die Betriebsbedingungen aufmerksam durch.

Falls Sie Fragen, im Hinblick auf die praktischen Anwendungen der Betriebsbedingungen haben, setzen Sie sich mit uns oder Ihrer zuständigen Kundendienststelle in Verbindung.

## Allgemeine Bedingungen

Die Geräte sind bis zur Aufstellung nur in der Originalverpackung zu transportieren und aufzubewahren.

Die Geräte dürfen nicht aufgestellt und nicht in Betrieb genommen werden, bevor die Betriebsbedingungen erfüllt sind.

Inbetriebnahme, Programmierung, Bedienung, Reinigung und Pflege unserer Geräte dürfen nur nach gründlichem Lesen unserer Anleitungen durchgeführt werden.

Die Geräte dürfen nur von geschultem Personal bedient werden.



### HINWEIS!

Wiederholt Schulungen durchzuführen.

Inhalt der Schulung sind die Kapitel 'Betriebsbedingungen', 'Material einlegen' und 'Wartung und Reinigung'.

Die Hinweise gelten ebenfalls für die von uns gelieferten Fremdgeräte.

Es dürfen nur Original Ersatz- und Austauschteile verwendet werden.

Bezüglich Ersatz-/Verschleißteilen bitte an den Hersteller wenden.

## Bedingungen an den Aufstellungsort

Die Aufstellfläche sollte eben, erschütterungs-, schwingungs- und luftzugsfrei sein.

Die Geräte sind so anzuordnen, dass eine optimale Bedienung und eine gute Zugänglichkeit zur Wartung möglich sind.

## Installation der bauseitigen Netzversorgung

Die Installation der Netzversorgung zum Anschluss unserer Geräte muss nach den internationalen Vorschriften und den daraus abgeleiteten Bestimmungen erfolgen. Hierzu gehören im Wesentlichen die Empfehlungen einer der drei folgenden Kommissionen:

- Internationale Elektronische Kommission (IEC)
- Europäisches Komitee für Elektronische Normung (CENELEC)
- Verband Deutscher Elektrotechniker (VDE)

Unsere Geräte sind nach VDE-Schutzklasse I gebaut und müssen an einen Schutzleiter angeschlossen werden. Die bauseitige Netzversorgung muss einen Schutzleiter haben, um geräteinterne Störspannungen abzuleiten.

## Technische Daten der Netzversorgung

Netzspannung und Netzfrequenz:	Siehe Typenschild
Zulässige Toleranz der Netzspannung:	+6 % ... -10 % vom Nennwert
Zulässige Toleranz der Netzfrequenz:	+2 % ... -2 % vom Nennwert
Zulässiger Klirrfaktor der Netzspannung:	≤ 5 %

### Entstörmaßnahmen:

Bei stark verseuchtem Netz (z.B. bei Einsatz von thyristorgesteuerten Anlagen) müssen bauseits Entstörmaßnahmen getroffen werden. Sie haben zum Beispiel folgende Möglichkeiten:

- Separate Netzzuleitung zu unseren Geräten vorsehen.
- In Problemfällen kapazitiv entkoppelten Trenntransformator oder sonstiges Entstörgerät in die Netzzuleitung vor unseren Geräten einbauen.

## Störstrahlung und Störfestigkeit

Störaussendung/Emission gemäß EN 61000-6-3: 2007 Industriebereich

- Störspannung auf Leitungen gemäß EN 55022: 09-2003
- Störfeldstärke gemäß EN 55022: 09-2003
- Oberschwingungsströme (Netzurückwirkung) gemäß EN 61000-3-2: 09-2006
- Flicker gemäß EN 61000-3-3: 1955 + A1:2001 + A2:2005

Störfestigkeit/Immunity gemäß EN 61000-6-2: 2005 Industriebereich

- Störfestigkeit gegen Entladung statischer Elektrizität gemäß EN 61000-4-2: 12-2001
- Elektromagnetischer Felder gemäß EN 61000-4-3: 11-2003, ENV 50204: 03-1995
- Störfestigkeit gegen schnelle elektrische Transienten (Burst) gemäß EN 61000-4-4: 07-2005
- Störfestigkeit gegen Stoßspannungen (Surge) gemäß EN 61000-4-5: 12-2001
- Hochfrequente Spannungen gemäß EN 61000-4-6: 12-2001
- Spannungsunterbrechungen und Spannungsabsenkung gemäß EN 61000-4-11: 02-2005



### HINWEIS!

Dies ist eine Einrichtung der Klasse A. Diese Einrichtung kann im Wohnbereich Funkstörungen verursachen; in diesem Fall kann vom Betreiber verlangt werden, angemessene Maßnahmen durchzuführen und dafür aufzukommen.

## Verbindungsleitungen zu externen Geräten

Alle Verbindungsleitungen müssen in abgeschirmten Leitungen geführt werden. Das Schirmgeflecht muss auf beiden Seiten großflächig mit dem Steckergehäuse verbunden werden.

Es darf keine parallele Leitungsführung zu Stromleitungen erfolgen. Bei unvermeidlicher Parallelführung ist ein Mindestabstand von 0,5 m einzuhalten.

Temperaturbereich der Leitungen: -15 ... +80 °C.

Es dürfen nur Geräte mit Stromkreisen angeschlossen werden die die Anforderung 'Safety Extra Low Voltage' (SELV) erfüllen. Im Allgemeinen sind dies Geräte, die nach EN 60950/EN 62368-1 geprüft sind.

## Installation Datenleitungen

Die Datenkabel müssen vollständig geschirmt und mit Metall- oder metallisierten Steckverbindergehäusen versehen sein. Geschirmte Kabel und Steckverbinder sind erforderlich, um Ausstrahlung und Empfang elektrischer Störungen zu vermeiden.

Zulässige Leitungen

Abgeschirmte Leitung:            4 x 2 x 0,14 mm<sup>2</sup> ( 4 x 2 x AWG 26)  
    6 x 2 x 0,14 mm<sup>2</sup> ( 6 x 2 x AWG 26)  
    12 x 2 x 0,14 mm<sup>2</sup> (12 x 2 x AWG 26)

Sende- und Empfangsleitungen müssen jeweils paarig verdrillt sein.

Maximale Leitungslängen:    bei Schnittstelle V 24 (RS232C) - 3 m (mit Abschirmung)  
    bei paralleler Schnittstelle - 3 m (mit Abschirmung)  
    bei USB - 3 m  
    bei Ethernet - 100 m

## Luftkonvektion

Um eine unzulässige Erwärmung zu vermeiden, muss sich um das Gerät eine freie Luftkonvektion bilden können.

## Grenzwerte

Schutzart gemäß IP:	20
Umgebungstemperatur °C (Betrieb):	Min. +5 Max. +35
Umgebungstemperatur °C (Lagerung):	Min. -20 Max. +60
Relative Luftfeuchte % (Betrieb):	Max. 80
Relative Luftfeuchte % (Lagerung):	Max. 80 (Betauung der Geräte nicht zulässig)

## Gewährleistung

Wir lehnen die Haftung für Schäden ab, die entstehen können durch:

- Nichtbeachtung unserer Betriebsbedingungen und Bedienungsanleitung.
- Fehlerhafte elektrische Installation der Umgebung.
- Bauliche Veränderungen an unseren Geräten.
- Fehlerhafte Programmierung und Bedienung.
- Nicht durchgeführte Datensicherung.
- Verwendung von nicht Original Ersatz- und Zubehörteilen.
- Natürlichem Verschleiß und Abnutzung.

Wenn Sie Geräte neu einstellen oder programmieren, kontrollieren Sie die Neueinstellung durch einen Probelauf und Probedruck. Sie vermeiden dadurch fehlerhafte Ergebnisse, Auszeichnungen und Auswertungen.

Die Geräte dürfen nur von geschulten Mitarbeitern bedient werden.

Kontrollieren Sie den sachgemäßen Umgang mit unseren Produkten und wiederholen Sie Schulungen.

Wir übernehmen keine Garantie dafür, dass alle in dieser Anleitung beschriebenen Eigenschaften bei allen Modellen vorhanden sind. Bedingt durch unser Streben nach ständiger Weiterentwicklung und Verbesserung besteht die Möglichkeit, dass sich technische Daten ändern, ohne dass eine Mitteilung darüber erfolgt.

Durch Weiterentwicklung oder länderspezifische Vorschriften können Bilder und Beispiele in den Anleitungen von der gelieferten Ausführung abweichen.

Bitte beachten Sie die Informationen über zulässige Druckmedien und die Hinweise zur Gerätepflege, um Beschädigungen oder vorzeitigen Verschleiß zu vermeiden.

Wir haben uns bemüht, dieses Handbuch in verständlicher Form zu verfassen, und Ihnen möglichst viele Informationen zu geben. Falls sich Fragen ergeben oder wenn Sie Fehler entdecken, bitte teilen Sie uns dies mit, damit wir die Möglichkeit haben, unsere Handbücher zu verbessern.

## Auspacken des Etikettendruckers

- ⇒ Etikettendrucker am Geräteboden anheben und aus dem Karton heben.
- ⇒ Etikettendrucker auf Transportschäden prüfen.
- ⇒ Lieferung auf Vollständigkeit prüfen.

## Lieferumfang

- Etikettendrucker.
- Folienkern (leer), auf Transferbandaufwicklung vormontiert.
- Abreißkante (nur bei Basisgeräten).
- Spendekante (nur bei Geräten mit Option Spender).
- Netzkabel.
- Dokumentation.
- Druckertreiber CD.
- Labelstar Office LITE.



### HINWEIS!

Originalverpackung für eventuelle spätere Lieferungen aufbewahren.

## Aufstellen des Etikettendruckers



### VORSICHT!

Beschädigung des Gerätes und der Druckmaterialien durch Feuchtigkeit und Nässe.

- ⇒ Etikettendrucker nur an trockenen und vor Spritzwasser geschützten Orten aufstellen.
- ⇒ Etikettendrucker auf ebener, erschütterungs-, schwingungs- und luftzugsfreier Fläche aufstellen.
- ⇒ Deckel des Etikettendruckers öffnen.
- ⇒ Transportsicherung aus Schaumstoff im Druckkopfbereich entfernen.

## Anschließen des Etikettendruckers

Der Etikettendrucker ist mit einem Weitbereichsnetzteil ausgerüstet. Der Betrieb mit einer Netzspannung von 110 ... 230 V AC / 50-60 Hz ist ohne Eingriff am Gerät möglich.



### VORSICHT!

Beschädigung des Gerätes durch undefinierte Einschaltströme.

- ⇒ Vor dem Netzanschluss den Netzschalter auf Stellung '0' bringen.
- ⇒ Netzkabel in Netzanschlussbuchse stecken.
- ⇒ Stecker des Netzkabels in geerdete Steckdose stecken.



### HINWEIS!

Durch unzureichende oder fehlende Erdung können Störungen im Betrieb auftreten.

Darauf achten, dass alle an den Etikettendrucker angeschlossenen Computer sowie die Verbindungskabel geerdet sind.

- ⇒ Etikettendrucker mit Computer oder Netzwerk mit einem geeigneten Kabel verbinden.

## Inbetriebnahme des Etikettendruckers

Wenn alle Anschlüsse hergestellt sind:

- ⇒ Etikettendrucker am Netzschalter einschalten.  
Nach Einschalten des Etikettendruckers erscheint das Grundmenü, aus welchem Druckertyp, aktuelles Datum und Uhrzeit zu ersehen sind.
- ⇒ Etikettenmaterial und Transferband einlegen.
- ⇒ Im Menü *Etikettenlayout/Etikett messen* den Messvorgang starten.
- ⇒ Taste  auf der Folientastatur drücken, um den Messvorgang zu beenden.



### HINWEIS!

Um eine korrekte Messung zu ermöglichen, müssen mindestens zwei vollständige Etiketten vorgeschoben werden (nicht bei Endlosetiketten).

Bei der Messung der Etiketten- und Schlitzlänge können geringe Differenzen auftreten. Aus diesem Grund können die Werte manuell im Menü *Etikettenlayout/Etiketten- und Schlitzlänge* eingestellt werden.

## Etikettenrolle im Abreißmodus einlegen

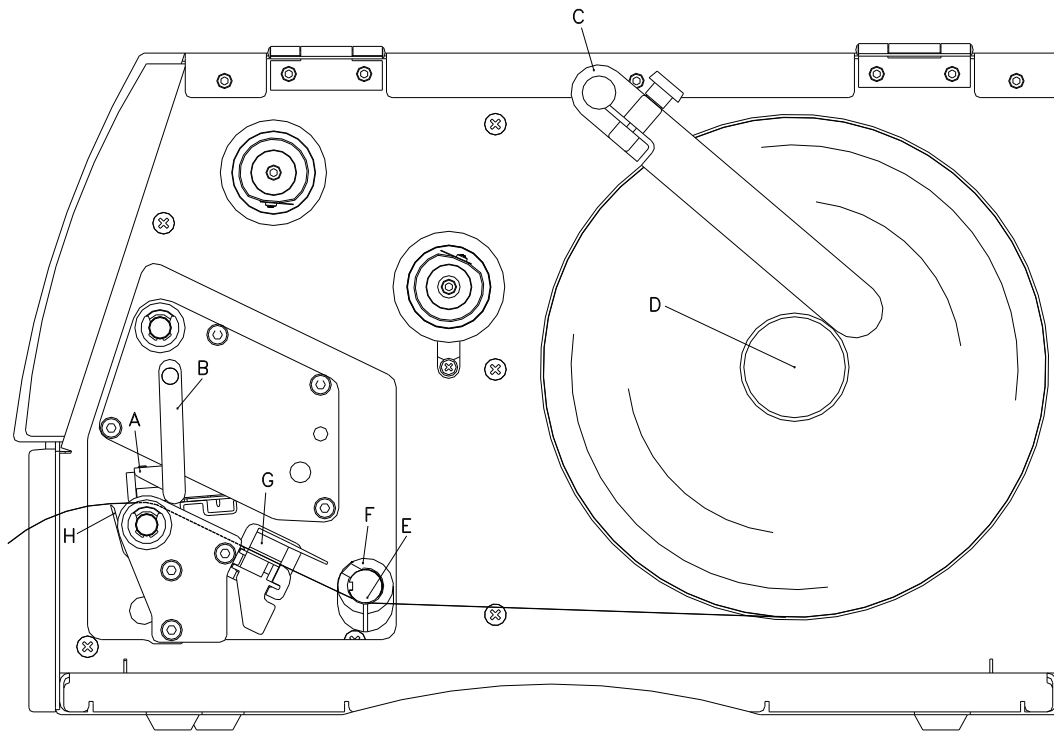

- Deckel des Druckers öffnen.
- Roten Andruckhebel (F) gegen den Uhrzeigersinn drehen, um Druckkopf (G) aufzuklappen.
- Äußere Etikettenhalterung (A) entfernen.
- Etikettenrolle mit Innenwicklung auf Abwickelvorrichtung (B) setzen und Etikettenhalterung (A) wieder anbringen.
- Etikettenmaterial unterhalb der Umlenkrolle (C) und des Druckkopfs (G) hindurchführen und darauf achten, dass das Material durch die Lichtschranke (E) läuft.
- Roten Andruckhebel (F) bis er einrastet im Uhrzeigersinn drehen, um den Druckkopf (G) anzuklappen.
- Vor dem Druckkopf ist die Abreißkante (H) ersichtlich.
- Offsetwert im Menüpunkt *Druck Initialisierung/Abreißkante* eingeben.
- Stellringe (D) auf der Umlenkrolle (C) auf die Materialbreite ausrichten.
- Deckel des Druckers wieder schließen.

## Transferband einlegen



### HINWEIS!

Für die Thermotransfer-Druckmethode muss ein Farbband eingelegt werden. Bei Verwendung des Etikettendruckers für den direkten Thermodruck wird kein Farbband eingelegt. Die im Etikettendrucker verwendeten Farbbänder müssen mindestens so breit sein wie das Druckmedium. Ist das Farbband schmäler als das Druckmedium, bleibt der Druckkopf teilweise ungeschützt und nutzt sich vorzeitig ab.

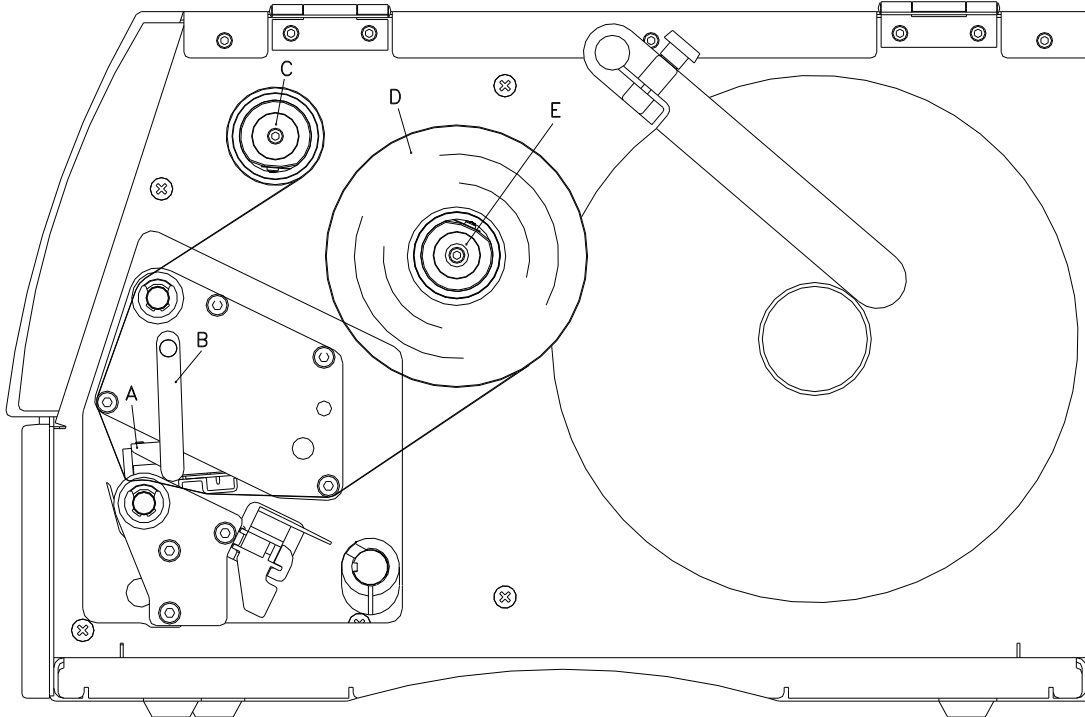

### HINWEIS!

Bevor eine neue Transferbandrolle eingelegt wird, ist der Druckkopf mit Druckkopf- und Walzenreiniger (97.20.002) zu reinigen. Die Handhabungsvorschriften zur Verwendung von Isopropanol (IPA) sind zu beachten. Bei Kontakt mit der Haut oder den Augen mit fließendem Wasser gründlich auswaschen. Bei anhaltender Reizung Arzt aufsuchen. Für gute Belüftung sorgen.

- Vor dem Einlegen des Transferbandes Druckkopf reinigen.
- Deckel des Druckers öffnen.
- Roten Andruckhebel (D) gegen den Uhrzeigersinn drehen, um Druckkopf (E) aufzuklappen.



### VORSICHT!

Schürff Gefahr beim Einlegen des Transferbandes bzw. beim Entnehmen des verbrauchten Transferbandes!  
⇒ Auf die Kanten des Federblechs achten!

- Transferbandrolle (B) mit Außenwicklung auf die Abwickelrolle (C) stecken.
- Farbband-Leerkern über die Aufwickelrolle (A) schieben und Transferband unterhalb des Druckkopfs (E) durchführen.
- Transferbandanfang mit einem Klebestreifen am Leerkern der Aufwickelrolle (A) fixieren. Hierbei die Rotationsrichtung der Transferbandaufwicklung gegen den Uhrzeigersinn beachten.
- Roten Andruckhebel (D) bis er einrastet im Uhrzeigersinn drehen, um den Druckkopf (E) anzuklappen.
- Deckel des Druckers wieder schließen.



### HINWEIS!

Da durch elektrostatische Entladung die dünne Beschichtung des Thermodruckkopfes oder andere elektronische Teile beschädigt werden können, sollte das Transferband antistatisch sein. Die Verwendung falscher Materialien kann zu Fehlfunktionen des Druckers führen und die Garantie erlöschen lassen.



### VORSICHT!

Einfluss von statischem Material auf den Menschen!  
⇒ Antistatisches Transferband verwenden, da es beim Entnehmen zur statischen Entladung kommen könnte.

## Print Settings (Druck Initialisierung)

Tastenfolge: , 

### Speed (Geschwindigkeit)

Angabe der Druckgeschwindigkeit in mm/s.  
Wertebereich: 50 mm/s ... 200 mm/s (siehe Technische Daten).

### Contrast (Brennstärke)

Angabe des Wertes, um die Druckintensität bei der Verwendung von unterschiedlichen Materialien, Druckgeschwindigkeiten oder Druckinhalten einzustellen.  
Wertebereich: 10 % ... 200 %

Taste: 

### Ribbon control (Transferbandüberwachung)

**Off (Aus):** Die Transferbandüberwachung ist deaktiviert.  
**On, weak sensibility (Ein, Empfindlichkeit schwach):** Die Transferbandüberwachung ist aktiviert. Der Drucker reagiert um ca. 1/3 langsamer auf das Ende des Transferbandes (Default).  
**On, strong sensibility (Ein, Empfindlichkeit stark):** Die Transferbandüberwachung ist aktiviert. Der Drucker reagiert sofort auf das Ende des Transferbandes.

Taste: 

### Y Offset (Y-Verschiebung)

Angabe der Nullpunktverschiebung in mm.  
Wertebereich: -30.0 ... +90.0

Taste: 

### X Offset (X-Verschiebung)

Verschiebung des gesamten Druckbilds quer zur Papierlaufrichtung.  
Wertebereich: -90.0 ... +90.0

Taste: 

### Tear-off Offset (Abreißkante)

Angabe des Wertes, um den das letzte Etikett eines Druckauftrags nach vorne geschoben und bei erneutem Druckstart wieder nach hinten an den Etikettenanfang gezogen wird.  
Wertebereich: 0 ... 50.0 mm  
Standard: 12 mm.

## Label layout (Etikettenlayout)

Tastenfolge: , , 

### Label length (Etikettenlänge)

Angabe der Etikettenlänge in mm  
Empfohlene Mindesthöhe: 5 mm (Spender 25 mm)

### Gap length (Schlitzlänge)

Angabe des Abstands zwischen zwei Etiketten in mm  
Empfohlener Mindestwert: 1 mm

Taste: 

### Column printing (Mehrbahniger Druck)

Angabe der Breite eines Etiketts sowie die Angabe wie viele Etiketten nebeneinander auf dem Trägermaterial sind.

Taste: 

### Measure label (Etikett messen)

Messvorgang mit Taste  starten.

Taste: 

### Label type (Etikettentyp)

Standardmäßig sind Haftetiketten eingestellt. Taste  drücken, um Endlosetiketten auszuwählen.

Taste: 

### Material selection (Materialauswahl)

Auswahl des Etiketten- bzw. Transferbandmaterials.

Taste: 

### Photocell (Lichtschanke)

Auswahl der verwendeten Lichtschranke.  
Folgende Möglichkeiten stehen zur Verfügung: Durchlicht-Lichtschanke normal und invers, Reflexions-Lichtschanke normal und invers, Ultraschall Lichtschranke (Option).

### Scan position (Abtastposition)

Mit Hilfe dieser Funktion kann die prozentuale Länge des Etiketts eingegeben werden, nach dem das Etikettenende gesucht wird.

Taste: **Label error length  
(Etiketten-Fehlerlänge)**

Angabe nach wie vielen mm, im Fall eines Fehlers, eine Meldung im Display erscheinen soll.  
Wertebereich: 1 ... 999 mm

**Synchronization  
(Synchronisieren)**

**On (Ein):** Falls ein Etikett auf dem Trägermaterial fehlt, wird eine Fehlermeldung angezeigt.  
**Off (Aus):** Fehlende Etiketten werden ignoriert, d.h. es wird in den Schlitz gedruckt.

Taste: **Flip label  
(Etikett spiegeln)**

Die Spiegelachse befindet sich auf der Mitte des Etiketts. Wenn die Etikettenbreite nicht an den Drucker übertragen wurde, wird die Default Etikettenbreite, d.h. die Breite des Druckkopfs verwendet. Aus diesem Grund sollten Sie darauf achten, dass das Etikett so breit wie der Druckkopf ist. Andernfalls könnte es zu Problemen bei der Positionierung führen.

Taste: **Rotate label  
(Etikett drehen)**

Standardmäßig wird das Etikett Kopf voraus mit 0° Drehung gedruckt. Wird die Funktion aktiviert, wird das Etikett um 180° gedreht und in Leserichtung gedruckt.

Taste: **Rotate label in degrees  
(Etikett drehen in Grad)**

Entsprechend dem Parameter *Etikett drehen* kann das Etikett in 90° Schritten gedreht werden.

**HINWEIS!**

Es können nur druckerinterne Objekte (Texte, Linien und Barcodes) gedreht werden. Die Drehung von Grafiken ist nicht möglich.

Taste: **Alignment  
(Ausrichtung)**

Die Ausrichtung des Etiketts erfolgt erst nach dem Drehen/Spiegeln, d.h. die Ausrichtung ist unabhängig von Drehung und Spiegelung.

**Left (Links):** Das Etikett wird am linken Rand des Druckkopfes ausgerichtet.

**Centre (Mitte):** Das Etikett wird am Mittelpunkt des Druckkopfes (zentriert) ausgerichtet.

**Right (Rechts):** Das Etikett wird am rechten Rand des Druckkopfes ausgerichtet.

**Device Settings (Geräteparameter)**Tastenfolge: , , , **Field handling  
(Feldverwaltung)**

**Off (Aus):** Der gesamte Druckspeicher wird gelöscht.

**Keep graphic (Grafik erhalten):** Eine Grafik bzw. ein TrueType Font wird einmal an den Drucker übertragen und im druckerinternen Speicher abgelegt. Für den folgenden Druckauftrag werden jetzt nur noch die geänderten Daten an den Drucker übertragen. Der Vorteil hierbei ist die Einsparung der Übertragungszeit der Grafikdaten.

**Delete graphic (Grafik löschen):** Die im druckerinternen Speicher abgelegten Grafiken bzw. TrueType Fonts werden gelöscht, die übrigen Felder jedoch erhalten.

**Restore graphic (Grafik wiederherstellen):** Nach Ende eines Druckauftrags kann am Drucker der gedruckte Auftrag erneut gestartet werden. Alle Grafiken und TrueType Schriften werden erneut gedruckt.

**HINWEIS!**

**Ausnahme:** Bei mehrbahnigem Druck müssen immer volle Bahnen gedruckt werden (Stückzahl immer Vielfaches der Bahnen). Gelöschte Bahnen werden nicht wiederhergestellt.

Taste: **Codepage  
(Codepage)**

Auswahl des zu verwendeten Zeichensatzes. Folgende Möglichkeiten stehen zur Verfügung: Codepage 437, Codepage 850, Codepage 852, Codepage 857, Codepage 1250, Codepage 1251, Codepage 1252, Codepage 1253, Codepage 1254, Codepage 1257, WGL4.

Die Tabelle zu den genannten Zeichensätzen finden Sie auf unserer Homepage.

Taste: **External parameters  
(Externe Parameter)**

**Label dimension only (Nur Etikettenabmessung):** Die Parameter für Etikettenlänge, Schlitzlänge und Etikettenbreite können übertragen werden. Alle weiteren Parametereinstellungen müssen direkt am Drucker vorgenommen werden.

**On (Ein):** Parameter können über unsere Etiketten-Gestaltungs-Software an den Drucker übertragen werden. Parameter die vorher direkt am Drucker eingestellt wurden, werden nicht mehr berücksichtigt.

**Off (Aus):** Es werden nur Einstellungen die am Drucker direkt gemacht werden berücksichtigt.



Taste: **Buzzer  
(Buzzer)****On (Ein):** Beim Drücken jeder Taste ist ein akustisches Signal hörbar.

Wertebereich: 1 ... 7

**Off (Aus):** Es ist kein Signal hörbar.**Display  
(Display)**

Einstellung des Kontrasts auf dem Display.

Wertebereich: 45 ... 75

Taste: **Language  
(Druckersprache)**

Auswahl der Sprache, in der die Texte im Druckerdisplay angezeigt werden sollen.  
 Folgende Möglichkeit stehen zur Verfügung: Deutsch, Englisch, Französisch, Spanisch, Finnisch, Tschechisch, Portugiesisch, Holländisch, Italienisch, Dänisch, Polnisch, Griechisch, Ungarisch, Russisch, Chinesisch (Option), Ukrainisch, Türkisch, Schwedisch, Norwegisch, Estnisch.



Taste: **Keyboard layout  
(Tastaturbelegung)**

Auswahl des Gebietschemas für die gewünschte Tastaturbelegung.

Folgende Möglichkeiten stehen zur Verfügung: Deutschland, England, Frankreich, Griechenland, Spanien, Schweden, US und Russland.

Taste: **Customized entry  
(Bedienereingabe)****Off (Aus):** Am Display erscheint keine Abfrage der bedienergeführten Variable. In diesem Fall wird der hinterlegte Default-Wert gedruckt.**On (Ein):** Die Abfrage nach der bedienergeführten Variablen erscheint einmalig vor Druckstart am Display.**Auto (Automatisch):** Die Abfragen nach der bedienergeführten Variablen und der Stückzahl erscheinen nach jedem Layout.**Auto without quantity query (Automatisch ohne Stückzahlabfrage):** Die Abfrage nach der bedienergeführten Variablen erscheint nach jedem Layout ohne zusätzliche Abfrage nach der Stückzahl.Taste: **Hotstart  
(Warmstart)****On (Ein):** Ein unterbrochener Druckauftrag kann nach erneutem Einschalten des Druckers wieder fortgesetzt werden.**Off (Aus):** Nach Abschalten des Druckers gehen sämtliche Daten verloren.Taste: **Autoload  
(Autoload)****On (Ein):** Ein Etikett das einmal von der Compact Flash Card geladen wurde, kann nach einem Neustart des Druckers automatisch wieder geladen werden.  
Es wird immer das zuletzt von CF Card geladene Etikett nach dem Neustart des Druckers neu geladen.**Off (Aus):** Nach einem Neustart des Druckers muss das zuletzt verwendete Etikett erneut manuell von der CF Card geladen werden.

Eine gemeinsame Nutzung der Funktionen Autoload und Warmstart ist nicht möglich.

Taste: **Manueller Nachdruck****Yes (Ja):** Ist der Etikettendrucker z.B. nach einem aufgetretenen Fehler im gestoppt-Modus, kann das zuletzt gedruckte Etikett mit den Tasten  und  nachgedruckt werden.**No (Nein):** Es werden nur leere Etiketten vorgeschoben.Taste: **Backfeed/Delay  
(Rückzug/Verzögerung)****Backfeed (Rückzug):** Der Rückzug in den Betriebsarten Spender (optional) und Messer (optional) ist optimiert worden, so dass beim Fahren in den Offset das nachfolgende Etikett falls möglich schon 'angedruckt' wird, und somit auf den Rückzug des Etiketts verzichtet, und dadurch Zeit eingespart werden kann.**Delay (Verzögerung):** Die einstellbare Verzögerungszeit ist nur für die Betriebsart *Rückzug Automatisch* von Bedeutung.Taste: **Label label change  
(Etikett Bestätigung)****On (Ein):** Ein neuer Druckauftrag wird erst nach Bestätigung am Gerät gedruckt.

Ein bereits aktiver fortlaufender Druckauftrag wird weiter gedruckt, bis die Bestätigung am Gerät erfolgt.

**Off (Aus):** Es erscheint keine Abfrage am Display der Ansteuerung.Taste: **Standard label  
(Standard Etikett)****On (Ein):** Wird ein Druckauftrag gestartet, ohne vorherige Definition eines Etiketts, wird das Standard-Etikett (Gerätetyp, Firmware Version, Build Version) gedruckt.**Off (Aus):** Wird ein Druckauftrag gestartet, ohne vorherige Definition eines Etiketts, erscheint eine Fehlermeldung im Display.

Taste: **Synchronization at switching on (Synchronisation beim Einschalten)****Off (Aus):** Die Synchronisierung ist deaktiviert, d.h. Messvorgang und Etikettenvorschub müssen manuell ausgelöst werden.**Measure (Messen):** Nach Einschalten des Druckers wird das eingelegte Etikett sofort ausgemessen.**Label feed (Etikettenvorschub):** Nach Einschalten des Druckers wird das Etikett an den Etikettenanfang synchronisiert. Dazu werden ein oder mehrere Etiketten vorgeschoben.Taste: **CMI length (CMI Länge)**

Wird der Druck im Etikett unterbrochen, kann es am Druckkopf zu einer kleinen Unterbrechung im Druckbild kommen bei der eine feine weiße Linie auf dem Etikett zu sehen ist. Um das zu vermeiden kann ein Wert für den minimalen Rückzug eingestellt werden (0 – 1 mm), um den das Etikettenmaterial zurückgezogen wird. Beim nächsten Druckstart wird der freie Bereich überdruckt. Die Einstellung der CMI Länge hat nur Auswirkung bei der Auswahl des Rückzug Modes Optimierter Rückzug.

**Network (Netzwerk)**Tastenfolge:     

Detaillierte Informationen zu diesem Menüpunkt sind dem separaten Handbuch zu entnehmen.

**Password (Passwort)**Tastenfolge:      **Operation (Bedienung)****Password (Passwort)** Eingabe eines 4-stelligen numerischen Passworts.Taste: **Protection configuration (Passwortschutz Funktionsmenü)**

Druckereinstellungen können verändert werden. (Brennstärke, Geschwindigkeit, Betriebsart, ...). Der Passwortschutz verhindert Veränderungen an der Druckereinstellung.

Taste: **Protection favorites (Passwortschutz Favoriten)**

Der Passwortschutz verhindert den Zugriff auf das Favoritenmenü.

Taste: **Protection memory card (Passwortschutz Speicherkarte)**

Mit den Speicherkarten Funktionen können Etiketten gespeichert, geladen, ... werden. Der Passwortschutz muss unterscheiden, ob keine oder nur lesende Speicherkartenzugriffe erlaubt sind.

**Vollzugriff:** Kein Passwortschutz  
**Nur lesen:** Nur lesende Zugriffe möglich  
**Geschützt:** Zugriffe gesperrtTaste: **Protection printing (Passwortschutz Drucken)**

Ist der Drucker an einen PC angeschlossen, kann es nützlich sein, wenn die Bedienperson manuell keinen Druck auslösen kann. Der Passwortschutz verhindert das manuelle Auslösen eines Drucks.

**Network (Netzwerk)****Password (Passwort)** Eingabe eines 15-stelligen Passworts. Die Eingabe kann aus alphanumerischen und Sonderzeichen bestehen.Taste: **Protection HTTP (Passwortschutz HTTP)**

Die Kommunikation über HTTP kann vermieden werden.

Taste: **Protection Telnet (Passwortschutz Telnet)**

Einstellungen des Telnet Dienst können nicht verändert werden.

Taste: 

**Protection remote access (Passwortschutz Fernzugriff)** Zugriff über eine externe HMI Schnittstelle kann verhindert werden.

**HINWEIS!**

Um eine gesperrte Funktion auszuführen, muss zuerst das gültige Passwort eingegeben werden. Ist das richtige Passwort eingegeben, wird die gewünschte Funktion ausgeführt.

**Interface (Schnittstellen)**Tastenfolge: , , , , , , , **COM1 / Baud / P / D / S****COM1:**

0 - serielle Schnittstelle Aus  
1 - serielle Schnittstelle Ein  
2 - serielle Schnittstelle Ein; es wird keine Fehlermeldung bei einem Übertragungsfehler ausgelöst

**Baud rate (Baud):**

Angabe der Bits die pro Sekunde übertragen werden. Folgende Werte können ausgewählt werden: 2400, 4800, 9600, 19200, 38400, 57600, 115200.

**P = Parity (Parität):**

N - No parity; E - Even; O - Odd  
Sie sollten darauf achten, dass die Einstellungen mit denen des Druckers übereinstimmen.

**D = Data bits (Datenbits):**



Einstellung der Datenbits. Sie können entweder 7 oder 8 Bits auswählen.

**S = Stop bits (Stoppbits):**



Sie haben die Möglichkeit, 1 oder 2 Stoppbits auszuwählen.  
Angabe der Stoppbits zwischen den Bytes.

Taste: **Start sign/End sign (Start-/Stoppzeichen)****SOH:** Start des Datenübertragungsblock → HEX-Format 01**ETB:** Ende des Datenübertragungsblock → HEX-Format 17Taste: **Data memory (Datenspeicher)****Standard (Standard):** Nach Starten eines Druckauftrags werden so lange Daten empfangen bis der Druckbuffer gefüllt ist.**Advanced (Erweitert):** Während eines laufenden Druckauftrags werden weiterhin Daten empfangen und verarbeitet.**Off (Aus):** Nach Starten eines Druckauftrags werden keine weiteren Daten empfangen.Taste: **(Port test) Schnittstellentest**

Überprüfung ob Daten über die Schnittstelle übertragen werden.

Tasten  und  drücken um Allgemein (On) auszuwählen. Taste  drücken und Daten die über einen beliebigen Port gesendet werden (COM1, LPT, USB, TCP/IP), werden gedruckt.

**Emulation (Emulation)**Tastenfolge: , , , , , , , , **Protocol (Protokoll)****CVPL:** Carl Valentin Programming Language**ZPL:** Zebra® Programming Language

Mit den Tasten  und  das Protokoll auswählen. Taste  drücken, um Auswahl zu bestätigen. Der Drucker wird neu gestartet und ZPL II®-Kommandos werden intern in CVPL-Kommandos umgewandelt.

Taste: **Printhead resolution (Druckkopf Auflösung)**

Bei aktivierter ZPL II®-Emulation muss die Druckkopf-Auflösung des emulierten Geräts eingestellt werden.

**HINWEIS**

Unterscheidet sich die Druckkopf-Auflösung des Zebra® Druckers von der des Valentin Geräts, so stimmt die Größe der Objekte (z.B. Texte, Grafiken) nicht genau überein.

Taste: **Drive mapping  
(Laufwerk Zuordnung)**

Der Zugriff auf Zebra®-Laufwerke wird auf entsprechende Valentin-Laufwerke umgeleitet.

**HINWEIS!**





Da die in Zebra® Druckern enthaltenen druckerinternen Fonts nicht in den Valentin Geräten vorhanden sind, kann es zu geringen Unterschieden im Schriftbild kommen.

Taste: **PJL – Printer Job  
Language  
(PJL – Printer Job  
Language)**

Es können den Druckauftrag betreffende Statusinformationen angezeigt werden.

**Date & Time (Datum & Uhrzeit)**Tastenfolge: , , , , , , , , , **Set date/time  
(Einstellen von Datum und  
Uhrzeit)**

Die obere Zeile des Displays zeigt das aktuelle Datum, die untere Zeile die aktuelle Uhrzeit an.

Mit Hilfe der Tasten  und  können Sie in das jeweils nächste Feld gelangen, um die angezeigten Werte mit den Tasten  und  zu erhöhen bzw. zu verkleinern.Taste: **Summertime  
(Sommerzeit)****On (Ein):** Der Drucker stellt automatisch auf Sommer- bzw. Winterzeit um.**Off (Aus):** Die Sommerzeit wird nicht automatisch erkannt und umgestellt.Taste: **Start of summertime -  
format  
(Beginn Sommerzeit -  
Format)**

Auswahl des Formats, um den Beginn der Sommerzeit einzugeben.

DD = Tag

WW = Woche

WD = Wochentag

MM = Monat,

Y = Jahr,

next day = erst der nächste Tag wird berücksichtigt

Taste: **Start of summertime - date  
(Beginn Sommerzeit –  
Datum)**

Eingabe des Datums wann die Sommerzeit beginnen soll. Diese Eingabe bezieht sich auf das zuvor ausgewählte Format.

Taste: **Start of summertime - time  
(Beginn Sommerzeit -  
Uhrzeit)**

Mit Hilfe dieser Funktion können Sie die Uhrzeit eingeben an der die Sommerzeit beginnen soll.

Taste: **End of summertime -  
format  
(Ende Sommerzeit -  
Format)**

Auswahl des Formats, um das Ende der Sommerzeit einzugeben.

Taste: **End of summertime - date  
(Ende Sommerzeit -  
Datum)**

Eingabe des Datums wann die Sommerzeit enden soll. Eingabe bezieht sich auf das zuvor ausgewählte Format.

Taste: **End of summertime - time  
(Ende Sommerzeit -  
Uhrzeit)**

Eingabe der Uhrzeit wann die Sommerzeit enden soll.

Taste: **Time shifting  
(Zeitverschiebung)**

Eingabe der Zeitverschiebung bei Sommer-/Winterzeit Umstellung in Stunden und Minuten.

## Service Functions (Service Funktionen)



### HINWEIS!

Damit der Händler bzw. der Druckerhersteller im Servicefall schnellen Support bieten kann, verfügt der Drucker über das Menü Service Funktionen.

Notwendige Informationen wie z.B. eingestellte Parameter, können direkt vom Drucker abgelesen werden.

Weitere Hinweise wie z.B. Firmware- oder Font Version können dem Grundmenü entnommen werden.

Tastenfolge: **F**, , , , , , , , , , 

#### Label parameters (Etikettenparameter)

Angabe der Etikettenparameter in Volt.

**A:** Anzeige des Mindestwerts.

**B:** Anzeige des Maximalwerts.

**C:** Der Wert der Schaltschwelle wird angezeigt. Wird beim Messen ermittelt und kann verändert werden.

Taste: 

#### Photocell configuration (Lichtschranken Einstellungen)

Diese Funktion ermöglicht das Einstellen der Lichtschrankenpegel.

Falls es zu Problemen bei der Positionierung bzw. beim Einmessen des Etiketts kommt, können die Pegel für die Etikettenlichtschranke manuell eingestellt werden. Achten Sie darauf, dass ein möglichst großer Hub (für Etikett >3 V, für Schlitz <1 V) eingestellt wird.

Taste: 

#### Photocell parameters (Lichtschranken Parameter)

**DLS:** Angabe des Pegels der Durchlicht-Lichtschranke in Volt.

**RLS:** Angabe des Pegels der Reflexions-Lichtschranke in Volt.

**SLS:** Angabe des Pegels der Spende-Lichtschranke in Volt.

**TR:** Angabe des Zustandes der Transferband-Lichtschranke (0 oder 1).

**H:** Angabe des Wertes 0 oder 1 für die Position des Druckkopfes.

0 = Druckkopf unten, 1 = Druckkopf oben

Taste: 

#### Paper counter (Laufleistung)

**D:** Angabe der Druckkopfleistung in Meter.

**G:** Angabe der Geräteleistung in Meter.

Taste: 

#### Heater resistance (Dot-Widerstand)

Um ein gutes Druckbild zu erzielen, muss bei einem Druckkopfwechsel der auf dem Druckkopf angegebene Ohm-Wert eingestellt werden.

Taste: 

#### Printhead temperature (Druckkopf Temperatur)

Anzeige der Druckkopftemperatur. Normalerweise liegt die Temperatur des Druckkopfes bei Raumtemperatur. Wird die maximale Druckkopftemperatur jedoch überstiegen, wird der laufende Druckauftrag unterbrochen und eine Fehlermeldung wird im Druckerdisplay angezeigt.

Taste: 

#### Motor ramp (Motor Rampe)

Je höher der '++'-Wert eingestellt ist, je langsamer wird der Vorschubmotor beschleunigt. Je kleiner der '--'-Wert eingestellt ist, je schneller wird der Vorschubmotor gebremst.

Taste: 

#### Print examples (Druck-Beispiele)

Durch Auslösen dieses Menüpunktes erhalten Sie einen Ausdruck mit sämtlichen Einstellungen.

##### Settings (Status Report):

Es werden sämtliche Geräteeinstellungen wie z.B. Geschwindigkeit, Transferbandmaterial etc. ausgedruckt.

##### Bar codes (Barcodes):

Es werden alle verfügbaren Barcodes ausgedruckt.

##### Fonts (Fonts):

Es werden alle Vektor und Bitmap Fonts ausgedruckt.

Taste: 

#### Input (Eingang)

Anzeige der Eingangs-Signalpegel.

0 = Low

1 = High

Taste: 

#### Output (Ausgang)

Anzeige der Ausgangs-Signalpegel.

0 = Low

1 = High

Taste: **I/O status  
(I/O Status)**

Relevante Ereignisse werden gezählt und im RAM Speicher mitprotokolliert. Das Protokoll geht nach Ausschalten des Gerätes verloren.

**RInt** = Real Interrupts

Zählt die Starteingangsimpulse direkt am Interrupt.

**Dbnc** = Debounced

Zählt die Starteingangsimpulse die länger als die eingestellte Entprellzeit sind. Nur diese Startimpulse können zu einem Druck führen. Ist ein Startimpuls zu kurz löst er keinen Druck aus. Zu erkennen ist das daran, dass RInt zählt, Dbnc nicht.

**NPrn** = Not Printed

Zählt entprellte Starteingangsimpulse die nicht zu einem Druck geführt haben. Ursachen dafür: kein Druckauftrag aktiv, Druckauftrag angehalten (manuell oder wegen eines Fehlers) oder das Drucksystem ist noch mit dem Abarbeiten eines Druckauftrags aktiv.

**PrtStrtReset** = Setzt alle Zähler zurück.

**PrtStrtTime** = Gemessene Länge des letzten Startimpulses in ms.

Taste: **Cutter photocell  
(Messer Lichtschranke)**

1 = Der Drucker ist mit einem Messer ausgestattet.

0 = Der Drucker ist nicht mit einem Messer ausgestattet.

**Cutter Home (CH)**

1 = Das Messer befindet sich in der Grundposition und ist somit zum Schneiden bereit.

0 = Das Messer befindet sich noch nicht in der Ausgangsposition und muss erst in diese gebracht werden bevor der Schneidevorgang ausgelöst werden kann.

Taste: **Online/Offline  
(Online/Offline)**

Ist die Funktion aktiviert, kann mit der Taste  zwischen Online und Offline Mode gewechselt werden (Standard = Aus).

**Online:** Daten können über Schnittstellen empfangen werden. Die Tasten der Folientastatur sind nur aktiv, wenn mit der Taste  in den Offline Mode gewechselt wurde.

**Offline:** Die Tasten der Folientastatur sind wieder aktiv aber empfangene Daten werden nicht mehr abgearbeitet. Wenn das Gerät wieder im Online Mode ist, werden wieder neue Druckaufträge empfangen.

Taste: **Transfer ribbon warning  
(Transferband  
Vorwarnung)**

**TRB = Transfer ribbon advance warning (Transferband Vorwarnung):**

Vor dem Ende des Transferbands wird ein Signal über einen Steuerausgang ausgegeben.

**Warning diameter (Vorwarnung Durchmesser):**

Einstellung des Transferbandvorwarnungsdurchmessers.

Wird an dieser Stelle ein Wert in mm eingegeben, wird bei Erreichen dieses Durchmessers (gemessen an der Transferbandrolle) ein Signal über einen Steuerausgang gegeben.

**Ribbon advance warning mode (Betriebsart für Vorwarnung):**

**Warning (Warnung):** Bei Erreichen des Vorwarnungsdurchmessers wird der entsprechende I/O Ausgang gesetzt.

**Reduced print speed (Reduzierte Geschwindigkeit):** Geschwindigkeit auf die die Druckgeschwindigkeit reduziert werden soll.

**Error (Fehler):** Das Drucksystem bleibt bei Erreichen des Vorwarndurchmessers mit 'zu wenig Transferband' stehen.

**Reduced print speed (Reduzierte Geschwindigkeit):**

Einstellung der reduzierten Druckgeschwindigkeit in mm/s. Diese kann in den Grenzen der normalen Druckgeschwindigkeit eingestellt werden.

Taste: **Zero point adjustment  
in Y direction  
(Nullpunkt Abgleich in  
Y Richtung)**

Die Eingabe des Wertes erfolgt in 1/100 mm.

Falls nach dem Austauschen des Druckkopfs, der Druck nicht an der gleichen Stelle auf dem Etikett fortgesetzt wird, kann diese Differenz in Druckrichtung korrigiert werden.

**HINWEIS!**

Der Wert für den Nullpunkt Abgleich wird ab Werk eingestellt und darf nur beim Austauschen des Druckkopfes durch Service Personal neu eingestellt werden.

Taste: **Zero point adjustment  
in X direction  
(Nullpunkt Abgleich in  
X Richtung)**

Die Eingabe des Wertes erfolgt in 1/100 mm.  
Falls nach dem Austauschen des Druckkopfs, der Druck nicht an der gleichen Stelle auf dem Etikett fortgesetzt wird, kann diese Differenz quer zur Druckrichtung korrigiert werden.

**HINWEIS!**

Der Wert für den Nullpunkt Abgleich wird ab Werk eingestellt und darf nur beim Austauschen des Druckkopfes durch Service Personal neu eingestellt werden.

Taste: **Print length +/-  
(Drucklänge +/-)**

Einstellung der Korrektur des Druckbildes in Prozent.  
Durch mechanische Einflüsse (z.B. Rollengröße) kann das Druckbild sowohl vergrößert als auch verkleinert im Verhältnis zur Originalgröße gedruckt werden.  
Wertebereich: +10.0 % ... -10.0 %

Taste: **Write log files on MC  
(Logdateien auf MC  
schreiben)**

Über dieses Kommando werden verschiedene LOG Dateien auf ein vorhandenes Speichermedium (MC-Karte) geschrieben. Nach der 'Fertig' Meldung kann das Speichermedium entfernt werden.

Die Dateien befinden sich im Verzeichnis 'log':

**LogMemErr.txt:** Protokollierte Fehler mit Zusatzinformationen wie z.B. Datum/Uhrzeit und Dateiname/Zeilennummer (für Entwickler)

**LogMemStd.txt:** Protokollierung ausgewählter Ereignisse

**LogMemNet.txt:** Die zuletzt über Port 9100 geschickten Daten

**Parameters.log:** Alle Druckerparameter in menschenlesbarer Form

**TaskStatus.txt:** Die Stati aller Drucker-Tasks

**Main Menu (Grundmenü)**



















Nach Einschalten des Etikettendruckers wird das Grundmenü angezeigt. Das Grundmenü zeigt Informationen wie z.B. den Druckertyp, aktuelles Datum und aktuelle Uhrzeit, Versionsnummer der Firmware und der verwendeten FPGAs.

Die ausgewählte Anzeige wird nur für eine kurze Zeit angezeigt, danach wird wieder zurück zur ersten Information gewechselt.

Mit der Taste  kann jeweils zur nächsten Anzeige gelangt werden.

## Compact Flash Card / USB Speicherstick\*

Mit den Tasten der Folientastatur des Druckers oder mit verschiedenen Funktionstasten einer angeschlossenen USB-Tastatur wird das Memory-Menu bedient.

		Zurück zum letzten Menü.
		In der Funktion <i>Load layout</i> (Layout laden): Wechsel in den File Explorer. File Explorer: Wechsel zum Kontext Menü.
		Markieren einer Datei/eines Verzeichnis, wenn eine Mehrfachauswahl möglich ist.
		Grundmenü: Auswahl des Memory Menüs. File Explorer: Erstellen einer neuen Datei.
		Ausführen der aktuellen Funktion für die aktuelle Datei/das aktuelle Verzeichnis.
		Wechsel in das übergeordnete Verzeichnis.
		Wechsel in das aktuell markierte Verzeichnis.
		Im aktuellen Verzeichnis nach oben scrollen.
		Im aktuellen Verzeichnis nach unten scrollen.

### Define user directory (Benutzerverzeichnis festlegen)

Legt das Standardverzeichnis fest in dem die Dateien zur Bearbeitung abgelegt sind.



#### HINWEIS!

Ein Benutzerverzeichnis muss definiert werden:

- bevor eine Benutzung bzw. Navigation durch das Memory Menü erfolgen soll.
- wenn die Formatierung der CF Karte am PC ausgeführt und somit das STANDARD Verzeichnis nicht automatisch angelegt wurde.

```
File Explorer
A:\
[Drives]
-><STANDARD>
<DIR_1>

Context Menu
A:
->Set as user dir
Format
Copy
```



Zugriff auf das Memory Menü.



File Explorer aufrufen.



Verzeichnis auswählen.



Anzeige der verfügbaren Funktionen



Funktion *Set as user dir* (als Benutzerverzeichnis) auswählen



Auswahl bestätigen.



Zurück ins Grundmenü.

Beim nächsten Aufrufen des Memory Menüs wird das ausgewählte Verzeichnis als Benutzerverzeichnis angezeigt.

### Load layout (Layout laden)

Laden eines Layouts innerhalb des festgelegten Benutzerverzeichnisses. Die Funktion ermöglicht einen schnellen Zugriff auf das gewünschte Layout da nur Layout-Dateien angezeigt und Verzeichnisse ausgeblendet werden.

```
Load layout
A:\STANDARD
->File_name1.prn
File_name2.prn
File_name3.prn
File_name4.prn
```



Zugriff auf das Memory Menü.



Layout auswählen.



Auswahl bestätigen.

Das Fenster zur Stückzahleingabe wird automatisch angezeigt.

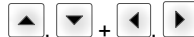

Anzahl der Layouts auswählen, die gedruckt werden sollen.



Druckauftrag starten.



#### HINWEIS!

Das Verzeichnis kann hier NICHT gewechselt werden. Ein Verzeichniswechsel MUSS im File Explorer mit der Funktion *Change directory* (Verzeichnis wechseln) vorgenommen werden.

\* nicht verfügbar



## File Explorer

Der File Explorer ist das Dateiverwaltungssystem des Drucksystems. Die Hauptfunktionen für die Oberfläche des Memory Menüs werden im File Explorer zur Verfügung gestellt.

In der Ansicht des Benutzerverzeichnisses die Taste **F** drücken um in den File Explorer zu gelangen.

Folgende Funktionen können ausgewählt werden:

- Laufwerk bzw. Verzeichnis wechseln
- Datei laden
- Layout bzw. Konfiguration speichern
- Datei(en) löschen
- CF Karte formatieren
- Datei(en) kopieren

## Change directory (Verzeichnis wechseln)

Auswahl des Laufwerks bzw. des Verzeichnisses in dem die Dateien abgelegt sind.

```
File Explorer
A:\
[Drives]
-><STANDARD>
<DIR_1>

File Explorer
A:\STANDARD\
-><..>
layout01
layout02
```



Zugriff auf das Memory Menü.



File Explorer aufrufen.



Verzeichnis auswählen.



Auswahl bestätigen.

Das ausgewählte Verzeichnis wird angezeigt.

## Load file (Datei laden)

Lädt eine beliebige Datei. Dies kann eine zuvor gespeicherte Konfiguration, ein Layout, etc. sein.

```
Load file
A:\STANDARD\
<..>
->layout01
layout02
```



Zugriff auf das Memory Menü.



File Explorer aufrufen.

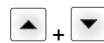

Datei auswählen.



Ausgewählte Datei wird geladen.



### HINWEIS!

Handelt es sich bei der ausgewählten Datei um ein Layout, kann die Anzahl der zu druckenden Kopien sofort eingegeben werden.

## Save layout (Layout speichern)

Sichert das aktuell geladene Layout unter dem ausgewählten Namen.

```
Save file
A:\STANDARD
->Save layout
Save config.
noname
```



Zugriff auf das Memory Menü.



File Explorer aufrufen.



Wechsel in das Menü *Save file* (Datei speichern).



Funktion *Save layout* (Layout speichern) auswählen.







Auswahl bestätigen.

Ist eine USB-Tastatur angeschlossen, kann für *noname* ein neuer Dateiname vergeben werden.

**Save configuration  
(Konfiguration speichern)**

```
Save file
A:\STANDARD
Save layout
→ Save config.
config.cfg
```

Sichert die komplette, aktuelle Druckerkonfiguration unter dem ausgewählten Namen.

-  Zugriff auf das Memory Menü.
-  File Explorer aufrufen.
-  Wechsel in das Menü *Save file* (Datei speichern).
-  Funktion *Save configuration* (Konfiguration speichern) auswählen.
-  Auswahl bestätigen.



Ist eine USB-Tastatur angeschlossen, kann für *config.cfg* ein neuer Dateiname vergeben werden.

**Delete file  
(Datei löschen)**

```
File Explorer
A:\STANDARD\
 layout01 *
→ layout02 *
 layout03
 layout04

Context menu
2 objects marked
→ Delete
 Copying
```

Löscht eine oder mehrere Dateien oder Verzeichnisse unwiderruflich. Beim Löschen eines Verzeichnisses werden sowohl die enthaltenen Dateien als auch Unterverzeichnisse gelöscht.

-  Zugriff auf das Memory Menü.
-  File Explorer aufrufen.
-  Datei auswählen.
-  Dateien markieren die gelöscht werden sollen. Die markierten Einträge werden mit \* gekennzeichnet. Diesen Vorgang solange durchführen bis alle gewünschten Dateien bzw. Verzeichnisse zum Löschen markiert sind.
-  Wechsel in das Kontextmenü.
-  Funktion *Delete* (Löschen) auswählen.
-  Auswahl bestätigen.

**Formatting  
(Formatieren)**

Formatiert unwiderruflich eine Speicherkarte.









**HINWEIS!**

USB-Sticks können nicht am Drucker formatiert werden!

```
File Explorer
DRIVES
→ A: 954Mb free
 U: No media

Context menu
A:\
 Set as user dir
→ Formatting
 Copy
```

-  Zugriff auf das Memory Menü.
-  File Explorer aufrufen.
-  Laufwerk auswählen das formatiert werden soll.
-  Wechsel in das Kontextmenü.
-  Funktion *Formatting* (Formatieren) auswählen.
-  Auswahl bestätigen.

### Copying (Kopieren)

```
File Explorer
A:\STANDARD\
layout01 *
→ layout02 *
layout03
layout04
```

```
Context menu
2 objects marked
Delete
→ Copying
```

```
Select Destination
DRIVES
→ A: 954Mb free
```

Erstellt ein Duplikat der ursprünglichen Datei bzw. des ursprünglichen Verzeichnisses um anschließend unabhängig vom Original Änderungen durchführen zu können.



Zugriff auf das Memory Menü.



File Explorer aufrufen.



Datei auswählen.



Dateien markieren die kopiert werden sollen. Die markierten Einträge werden mit \* gekennzeichnet. Diesen Vorgang solange durchführen bis alle gewünschten Dateien bzw. Verzeichnisse zum Kopieren markiert sind.



Wechsel in das Kontextmenü.



Funktion *Copying* (Kopieren) auswählen.



Ziel des Kopiervorgangs festlegen.

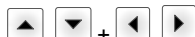

Ziel-Speicherort auswählen.



Auswahl bestätigen.

### Filter:

#### Nur in Verbindung mit einer USB-Tastatur möglich.

Ist eine USB-Tastatur angeschlossen, kann bei bestimmten Funktionen eine Filtermaske oder der Dateiname einer zu speichernden Datei angegeben werden. Diese Eingabe wird in der Pfadzeile angezeigt. Mit der Filtermaske ist es möglich, nach bestimmten Dateien zu suchen. Zum Beispiel werden bei der Eingabe von „L“ nur Dateien angezeigt, die mit der Zeichenkette „L“ beginnen. (Groß-/Kleinschreibung wird nicht beachtet).

#### Ohne Filter

```
Load layout
A:\STANDARD
→ First_file.prn
Layout_new.prn
Sample.prn
12807765.prn
```

#### Mit Filter

```
Load layout
L
→ Layout_new.prn
```

## Technische Daten

	Vita II 103/8 T	Vita II 104/8	Vita II 106/12	Vita II 106/24	Vita II 108/12 T
Druckauflösung	203 dpi	203 dpi	300 dpi	600 dpi	300 dpi
Max. Druckgeschwindigkeit	200 mm/s	200 mm/s	150 mm/s	100 mm/s	150 mm/s
Druckbreite	104 mm	104 mm	105,7 mm	105,7 mm	108,4 mm
Durchlassbreite					
Standard	116 mm	116 mm	116 mm	116 mm	116 mm
Messerbetrieb	112 mm	112 mm	112 mm	112 mm	112 mm
Druckkopf	Flat Type <sup>1</sup>	Flat Type <sup>2</sup>	Flat Type <sup>2</sup>	Flat Type <sup>2</sup>	Flat Type <sup>1</sup>
<b>Etiketten</b>					
Etiketten- oder Endlosmaterial auf Rollen oder Leporello	Papier, Karton, Textil, Kunststoff				
Materialstärke	max. 220 gr/m <sup>2</sup> (größer auf Anfrage)				
Min. Etikettenbreite	12 mm				
Min. Etikettenhöhe					
Standard	5 mm				
Messer-/Spendebetrieb	15 mm				
Max. Etikettenhöhe	6000 mm	6000 mm	3000 mm	1000 mm	3000 mm
Max. Rollendurchmesser					
Abwicklung intern	180 mm				
Aufwicklung intern	---				
Kerndurchmesser	40 mm / 75 mm (Option)				
Wicklung	außen oder innen				
Etikettensensor	Durchlicht und Reflexion von unten				
<b>Transferband</b>					
Farbseite	außen oder innen				
Max. Rollendurchmesser	Ø 80 mm				
Kerndurchmesser	25,4 mm / 1"				
Max. Länge	450 m				
Max. Breite	110 mm				
<b>Abmessungen (mm)</b>					
Breite x Höhe x Tiefe	236 x 238 x 374				
Gewicht	11 kg				
<b>Elektronik</b>					
Prozessor	High Speed 32 Bit				
Arbeitsspeicher (RAM)	16 MB				
Steckplatz	für Compact Flash Karte Typ I				
Batterie	für Echtzeituhr (Datenspeicherung bei Netzabschaltung)				
Warnsignal	Akustisches Signal bei Fehler				
<b>Schnittstellen</b>					
Seriell	RS-232C (bis 115200 Baud)				
Parallel	SPP				
USB	2.0 High Speed Slave				
Ethernet	10/100 Base T, LPD, RawIP-Printing, DHCP, HTTP, FTP				
WLAN (Option)	Modul 802.11 b/g/n WEP, WPA, WPA-PSK, WPA2, WPA2-PSK, EAP				

<sup>1</sup> = Thermodirekt

<sup>2</sup> = Thermotransfer

<b>Betriebsbedingungen</b>	<b>Vita II 103/8 T</b>	<b>Vita II 104/8</b>	<b>Vita II 106/12</b>	<b>Vita II 106/24</b>	<b>Vita II 108/12 T</b>
Nennspannung	110 ... 230 V AC / 50-60 Hz				
Leistungsaufnahme	275 VA				
Nennstrom	2,5 A				
Betriebstemperatur	5 ... 35 °C				
Luftfeuchtigkeit	max. 80 % (nicht kondensierend)				
<b>Bedienfeld</b>					
Tasten	Testdruck, Funktionsmenü, Stückzahl, CF Karte, Feed, Enter, 4 x Cursor				
LCD-Anzeige	Grafikdisplay 132 x 64 Pixel				
<b>Einstellungen</b>					
	Datum, Uhrzeit, Schichtzeiten 20 Spracheinstellungen (weitere auf Anfrage) Etiketten-, Geräteparameter, Schnittstellen, Passwortschutz				
<b>Überwachungen</b>					
Druckstopp bei	Transferbandende / Etikettenende / Druckkopf offen				
Statusausdruck	Ausdruck zu Geräteeinstellungen wie z.B. Laufleistung, Lichtschranken-, Schnittstellen-, Netzwerkparameter Ausdruck der internen Schriftarten sowie aller unterstützter Barcodes				
<b>Schriften</b>					
Schriftarten	6 Bitmap Fonts 8 Vektor Fonts/TrueType Fonts 6 Proportionale Fonts Weitere Schriftarten auf Anfrage				
Zeichensätze	Windows 1250 bis 1257, DOS 437, 850, 852, 857, UTF-8 Es werden alle west- und osteuropäischen, lateinischen, kyrillischen, griechischen und arabischen (Option) Zeichen unterstützt. Weitere Zeichensätze auf Anfrage				
Bitmap Fonts	Größe in Breite und Höhe 0,8 ... 5,6 Vergrößerungsfaktor 2 ... 9 Ausrichtung 0°, 90°, 180°, 270°				
Vektor Fonts/TrueType Fonts	Größe in Breite und Höhe 1 ... 99 mm Vergrößerungsfaktor stufenlos Ausrichtung 0°, 90°, 180°, 270°				
Schriftattribute	Abhängig von der Schriftart – fett, kursiv, invers, vertikal				
Zeichenabstand	Variabel				
<b>Barcodes</b>					
1D Barcodes	CODABAR, Code 128, Code 2/5 interleaved, Code 39, Code 39 extended, Code 93, EAN 13, EAN 8, EAN ADD ON, GS1-128, Identcode, ITF 14, Leitcode, Pharmacode, PZN 7 Code, PZN 8 Code, UPC-A, UPC-E				
2D Barcodes	Aztec Code, CODABLOCK F, DataMatrix, GS1 DataMatrix, MAXICODE, PDF 417, QR Code				
Composite Barcodes	GS1 DataBar Expanded, GS1 DataBar Limited, GS1 DataBar Omnidirectional, GS1 DataBar Stacked, GS1 DataBar Stacked Omnidirectional, GS1 DataBar Truncated				
	Alle Barcodes sind in Höhe, Modulbreite und Ratio variabel Ausrichtung 0°, 90°, 180°, 270° Wahlweise Prüfziffer und Klarschriftausdruck				
<b>Software</b>					
Konfiguration	ConfigTool				
Prozess Steuerung	NiceLabel				
Etikettensoftware	Labelstar Office Lite Labelstar Office				
Windowstreiber	Windows 7® - Windows 10® 32/64 Bit Windows Server 2008® (R2) - Windows Server 2019®				

Technische Änderungen vorbehalten

## Reinigung



### GEFAHR!

Lebensgefahr durch Stromschlag!

⇒ Vor allen Wartungsarbeiten den Etikettendrucker vom Stromnetz trennen und kurz warten, bis sich das Netzteil entladen hat.



### HINWEIS!

Für die Reinigung des Geräts sind persönliche Schutzeinrichtungen wie Schutzbrille und Handschuhe empfehlenswert.

Wartungsaufgabe	Häufigkeit
Allgemeine Reinigung.	Bei Bedarf.
Transferband-Zugwalze reinigen.	Bei jedem Wechsel der Transferbandrolle oder bei Beeinträchtigung des Druckbilds.
Andruckwalze reinigen.	Bei jedem Wechsel der Etikettenrolle oder bei Beeinträchtigung des Druckbilds und des Etikettentransports.
Druckkopf reinigen.	<b>Direkter Thermodruck:</b> Bei jedem Wechsel der Etikettenrolle. <b>Thermotransferdruck:</b> Bei jedem Wechsel der Transferband oder bei Beeinträchtigung des Druckbilds.
Etikettenlichtschranke reinigen.	Bei Austauschen der Etikettenrolle.



### HINWEIS!

Die Handhabungsvorschriften zur Verwendung von Isopropanol (IPA) sind zu beachten. Bei Kontakt mit der Haut oder den Augen mit fließendem Wasser gründlich auswaschen. Bei anhaltender Reizung Arzt aufsuchen. Für gute Belüftung sorgen.



### WARNUNG!

Brandgefahr durch leicht entzündlichen Etikettenlöser!

⇒ Bei Verwendung von Etikettenlöser muss der Etikettendrucker vollständig von Staub befreit und gereinigt sein.

## Allgemeine Reinigung



### VORSICHT!

Beschädigung des Etikettendruckers durch scharfe Reinigungsmittel!

⇒ Keine Scheuer- oder Lösungsmittel zur Reinigung der Außenflächen oder Baugruppen verwenden.

⇒ Staub und Papierfusseln im Druckbereich mit weichem Pinsel oder Staubsauger entfernen.

⇒ Außenflächen mit Allzweckreiniger säubern.

## Transferband-Zugwalze reinigen

Eine Verschmutzung der Zugwalze führt zu einer schlechteren Druckqualität und kann außerdem zu Beeinträchtigungen des Materialtransports führen.

- Deckel des Druckers öffnen.
- Transferband aus dem Etikettendrucker nehmen.
- Ablagerungen mit Walzenreiniger und weichem Tuch entfernen.
- Wenn die Walze Beschädigungen aufweist, Walze tauschen.

## Andruckwalze reinigen

Eine Verschmutzung der Andruckwalze führt zu einer schlechteren Druckqualität und kann außerdem zu Beeinträchtigungen des Materialtransports führen.



### VORSICHT!

Beschädigung der Andruckwalze!

⇒ Keine scharfen, spitzen oder harten Gegenstände zur Reinigung der Andruckwalze verwenden.

- Andruckhebel gegen den Uhrzeigersinn drehen, um den Druckkopf zu entriegeln.
- Etiketten und Transferband aus dem Etikettendrucker nehmen.
- Ablagerungen mit Walzenreiniger und weichem Tuch entfernen.
- Wenn die Walze Beschädigungen aufweist, Walze tauschen.

## Druckkopf reinigen

Während des Drucks kommt es zu Verunreinigungen am Druckkopf z.B. durch Farbpartikel des Transferbandes. Deshalb ist es sinnvoll und notwendig, den Druckkopf in gewissen Zeitabständen, abhängig von Betriebsstunden und Umgebungseinflüssen wie Staub usw., zu reinigen.



### VORSICHT!

Beschädigung des Druckkopfs!

⇒ Keine scharfen, spitzen oder harten Gegenstände zur Reinigung des Druckkopfs verwenden.

⇒ Glasschutzschicht des Druckkopfs nicht berühren.

- Andruckhebel gegen den Uhrzeigersinn drehen, um den Druckkopf zu entriegeln.
- Etiketten und Transferband aus dem Etikettendrucker nehmen.
- Druckkopfoberfläche mit einem in reinem Alkohol getränktem Wattestäbchen reinigen.
- Vor Inbetriebnahme des Etikettendruckers, Druckkopf 2 bis 3 Minuten trocknen lassen.

## Etikettenlichtschranke reinigen



### VORSICHT!

Beschädigung der Lichtschranke!

⇒ Keine scharfen oder harten Gegenstände oder Lösungsmittel zur Reinigung der Lichtschranke verwenden.

Die Etikettenlichtschranke kann durch Papierstaub verschmutzen. Dadurch kann die Etikettenabstastung beeinträchtigt werden.

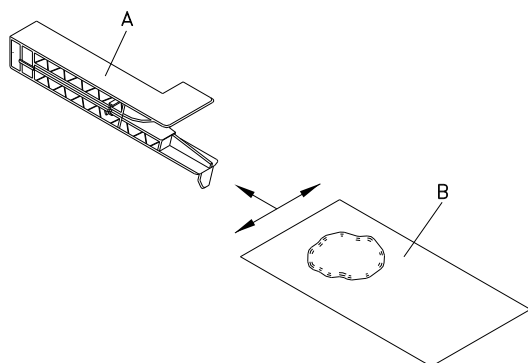

- Andruckhebel gegen den Uhrzeigersinn drehen, um den Druckkopf zu entriegeln.
- Etiketten und Transferband aus dem Etikettendrucker entnehmen.
- Lichtschranke (A) mit Druckgas-Spray ausblasen. Anweisungen auf der Dose beachten.
- Etikettenlichtschranke (A) kann zusätzlich mit einer Reinigungskarte (B) die zuvor mit reinem Alkohol befeuchtet wurde, gereinigt werden. Die Reinigungskarte ist hin und her zu schieben (siehe Abbildung).
- Etiketten und Transferband wieder einlegen.





Instrucciones abreviadas y  
recomendaciones de seguridad

Español

Copyright by Carl Valentin GmbH

Las indicaciones sobre el contenido del envío, el aspecto, las medidas, el peso se corresponden con nuestros conocimientos en el momento de la impresión de este documento.

Reservado el derecho a efectuar modificaciones.

Reservados todos los derechos, incluidos los de la traducción.

Prohibido reelaborar ningún fragmento de esta obra mediante sistemas electrónicos, así como multicopiarlo o difundirlo de cualquier modo (impresión, fotocopia o cualquier otro procedimiento) sin previa autorización de la empresa Carl Valentin GmbH.

Debido al constante desarrollo de los aparatos puede haber diferencias entre la documentación y el aparato.

La edición actual puede encontrarse bajo: [www.carl-valentin.de](http://www.carl-valentin.de).

### **Marcas comerciales (Trademarks)**

Todas las marcas o sellos comerciales nombrados son marcas o sellos registrados del correspondiente propietario y, en algunos casos, no tendrán un marcado especial. De la falta de marcado no se puede deducir que no se trate de una marca o sello registrado/a.

Las impresoras de etiquetas Carl Valentin cumplen las siguientes directrices de seguridad:

- CE** Directiva sobre baja tensión (2014/35/UE)
- Directiva sobre compatibilidad electromagnética (2014/30/UE)



### **Carl Valentin GmbH**

Postfach 3744  
78026 Villingen-Schwenningen  
Neckarstraße 78 – 86 u. 94  
78056 Villingen-Schwenningen

Phone +49 7720 9712-0  
Fax +49 7720 9712-9901

E-Mail [info@carl-valentin.de](mailto:info@carl-valentin.de)  
Internet [www.carl-valentin.de](http://www.carl-valentin.de)

---

## Contenido

Indicaciones para su empleo	36
Indicaciones de seguridad	36
Eliminación no contaminante	36
Condiciones de funcionamiento	37
Desembalaje la impresora	40
Contenido del material entregado	40
Colocación de la impresora	40
Conexión de la impresora	40
Puesta en funcionamiento la impresora	40
Colocación de las etiquetas en modo rasgado	41
Colocación de la cinta de transferencia	42
Print Settings (Inicialización de impresión)	43
Label Layout (Configuración etiqueta)	43
Device Settings (Parámetros del aparato)	44
Network (Red)	46
Password (Contraseña)	46
Interface (Puertos)	47
Emulation (Emulación)	47
Date & Time (Fecha & Hora)	48
Service Functions (Funciones de asistencia técnica)	49
Main Menu (Menú principal)	51
Tarjeta de Memoria Compact Flash	52
Datos técnicos	56
Limpieza del rodillo de tracción de cinta de transferencia	58
Limpieza del rodillo de presión	59
Limpieza del cabezal de impresión	59
Limpieza de la fotocélula	59

## Indicaciones para su empleo

- La impresora de etiquetas ha sido construida conforme al estado de la técnica y a las reglas de seguridad técnica vigentes. No obstante, durante la utilización pueden producirse serios peligros para el usuario o para terceros, así como daños a la impresora de etiquetas y otros daños materiales.
- Únicamente se debe utilizar la impresora de etiquetas en perfectas condiciones técnicas, de una manera adecuada, teniendo en cuenta la seguridad y los peligros que se corren, y de acuerdo con las instrucciones de manejo. En especial deben resolverse inmediatamente los problemas que afecten a la seguridad.
- La impresora de etiqueta está diseñada exclusivamente para imprimir materiales adecuados y autorizados por el fabricante. Cualquier otro uso no contemplado en lo anterior se considera contrario a lo prescrito. El fabricante/proveedor no asume ninguna responsabilidad por los daños resultantes de un uso incorrecto.
- También forma parte del uso adecuado seguir las instrucciones de manejo y cumplir los requisitos/normas de mantenimiento indicados por el fabricante.

## Indicaciones de seguridad

- La impresora de etiquetas está diseñada para funcionar con redes eléctricas con una corriente alterna de 110 ... 230 V AC. Conecte la impresora de etiquetas únicamente a tomas de corriente con contacto con conductor de protección a tierra.
- Acople la impresora de etiquetas únicamente a aparatos con bajo voltaje de seguridad.
- Antes de establecer o soltar conexiones debe desenchufarse todos los aparatos implicados (ordenador, impresora, accesorios)..
- Utilice la impresora de etiquetas en entornos secos y sin humedad (salpicaduras de agua, niebla, etc.).
- Los trabajos de mantenimiento y conservación de sólo pueden ser ejecutados por personal especializado instruido.
- El personal de operaciones debe ser instruido por el gestor de acuerdo al manual de instrucciones.
- Si se utiliza la impresora de etiquetas con la tapa abierta, debe tenerse en cuenta que ni la ropa, ni el pelo ni las joyas o similares entren en contacto con las partes rotativas que están al descubierto.
- El dispositivo y las piezas (p.ej. pulsador) de ellos pueden calentarse durante el servicio. No lo toque durante el funcionamiento y déjelo enfriar antes de efectuar un cambio de material, de desmontarlo o ajustarlo.
- Jamás emplee material de consumo fácilmente inflamable.
- Existe el riesgo de que el borde de rasgado cause daños. Si no va a usar el borde de rasgado, ponga el protector a dicho borde.
- Realice sólo las acciones descritas en este manual de usuario. Las acciones no incluidas en este manual deberán ser realizadas únicamente por el fabricante o en coordinación con el fabricante.
- La interferencia de módulos electrónicos no autorizados o su software pueden causar problemas de funcionamiento.
- Las modificaciones y alteraciones no autorizadas realizadas en el aparato pueden poner en peligro su seguridad operacional.
- Siempre haga los trabajos de servicio y mantenimiento en un taller adaptado a tal uso, donde el personal tenga conocimientos técnicos y herramientas requeridas para hacer los trabajos necesarios.
- Hay adhesivos de atención en el módulo de impresión directa que le alertan de los peligros. Por lo tanto, no retire los adhesivos de atención para que usted u otra persona estén al tanto de los peligros o posibles daños.



### ¡PELIGRO!

¡Peligro de muerte o daños corporales graves por electricidad!

⇒ No abra la cubierta del módulo de impresión directa.

## Eliminación no contaminante

Los fabricantes de aparatos B2B están obligados desde el 23/03/2006 a recibir de vuelta y reciclar los residuos de aparatos fabricados después del 13/08/2005. Está terminantemente prohibido deponer dichos residuos en puntos de recolección comunales. Únicamente el fabricante está autorizado para reciclarlos y eliminarlos en forma organizada. Por ello, en el futuro los productos Valentin que lleven la identificación correspondiente podrán ser retornados a Carl Valentin GmbH. Los residuos de aparatos serán eliminados entonces en forma apropiada.

Con ello, Carl Valentin GmbH asume oportunamente todas las obligaciones en el marco de la eliminación de residuos de aparatos, posibilitando de ese modo también la venta sin obstáculos de los productos. Únicamente podemos aceptar aparatos enviados francos de porte.

El circuito impreso electrónico del sistema de presión está equipado con una batería de litio. Estas deben ser eliminadas en recipientes colectores de baterías usadas del revendedor o los responsables públicos de eliminación.

Puede obtenerse más información leyendo la directiva RAEE o nuestra página web [www.carl-valentin.de](http://www.carl-valentin.de).

## Condiciones de funcionamiento

Antes de la puesta en marcha de la impresora y durante su uso, deberá comprobar que se cumplen las condiciones de funcionamiento aquí descritas. Sólo así quedará garantizado un funcionamiento del aparato en condiciones de seguridad y libre de interferencias.

Por favor, lea atentamente las condiciones de funcionamiento.

En caso de que necesite consultar acerca de las aplicaciones prácticas de las condiciones de servicio, póngase en contacto con nosotros o con el servicio de asistencia técnica que le corresponda.

## Condiciones generales

Los equipos deben transportarse y almacenarse sólo en su embalaje original.

Los equipos no pueden colocarse ni ponerse en funcionamiento antes de que se hayan cumplido todas las condiciones de servicio.

La puesta en marcha, programación, manejo, limpieza y cuidado de nuestros equipos solo puede llevarse a cabo tras leer cuidadosamente nuestras instrucciones.



### ¡AVISO!

Les aconsejamos dar cursillos de repetición.

El contenido de los cursillos son los capítulos 'Condiciones de funcionamiento', 'Colocar el material' y el capítulo 'Mantenimiento y limpieza'.

Las observaciones son de aplicación asimismo para los equipos de terceros suministrados por nosotros.

Sólo pueden utilizarse repuestos y piezas de recambio originales.

Para cualquier información sobre las piezas de recambio/desgaste, diríjase al fabricante.

## Condiciones del lugar de emplazamiento

El lugar de instalación debe ser liso y sin vibraciones. Deben evitarse las corrientes de aire.

Los aparatos se dispondrán de tal manera que se asegure su óptimo mantenimiento y accesibilidad.

## Instalación de la fuente de alimentación

La instalación de la fuente de alimentación para conectar nuestras impresoras debe efectuarse de conformidad con la regulación y los acuerdos internacionales aplicables, y las disposiciones de ellos derivadas. En particular, debe efectuarse atendiendo a las recomendaciones de una de las tres comisiones siguientes:

- Comisión Internacional de electrotécnica (IEC)
- Comité Europeo de Normalización Electrotécnica (CENELEC)
- Federación de Electrotécnicos Alemanes (VDE)

Nuestros aparatos están diseñados de acuerdo con lo establecido por la VDE para el tipo de prevención (Schutzklasse I), y deben ser conectadas a un conector puesto a tierra. La fuente de alimentación debe tener un conector de tierra o aterrizado, para eliminar interferencias internas en el voltaje.

## Datos técnicos de la fuente de alimentación

Tensión y frecuencia de red:	Véase placa de características
Tolerancia permitida de tensión de red:	+6 % ... -10 % del valor nominal
Tolerancia permitida de frecuencia de red:	+2 % ... -2 % del valor nominal
Factor de distorsión no lineal permitido:	≤ 5 %

### Medidas anti-interferencia:

En el caso de que la red se encuentre fuertemente contaminada (p.ej. en el caso de emplearse instalaciones controladas por tiristores), el cliente deberá tomar medidas anti-interferencia. Como medidas pueden tomarse, por ejemplo, las indicadas a continuación:

- Instale una toma de corriente independiente para nuestros aparatos.
- En el caso de problemas, instale un transformador de separación capacitado para desacoplamiento, u otro supresor de interferencias similar, en nuestros aparatos.

## Radiación parásita e inmunidad a las interferencias

Interferencia emitida según EN 61000-6-3: 2007 área de industria

- Corriente parásita en líneas de alimentación según EN 55022: 09-2003
- Intensidad del campo parasitario según EN 55022: 09-2003
- Corrientes armónicas (retroalimentación a la red) según EN 6100—3-2: 09-2006
- Flicker según EN 61000-3-3: 1955 + A1:2001 + A2:2005

Inmunidad a las interferencias según EN 61000-6-2: 2005 área de industria

- Inmunidad a las interferencias frente a la descarga de energía estática según EN 61000-4-2: 12-2001
- Campos electromagnéticos según EN 61000-4-3: 11-2003, ENV 50204: 03-1995
- Inmunidad a las interferencias frente a transientes o descargas eléctricas rápidas (Burst) según EN 61000-4-4: 07-2005
- Inmunidad a las interferencias frente a oscilaciones bruscas (sobretensión) según EN 61000-4-5: 12-2001
- Tensión HF según EN 61000-4-6: 12-2001
- Cortes y caídas de tensión según EN 61000-4-11: 02-2005



### ¡AVISO!

Este es un dispositivo de tipo A. Este aparato puede producir radiointerferencias en zonas habitadas. En dicho caso, se podrá exigir al usuario que tome las medidas apropiadas y que se haga responsable de las mismas.

## Conexión a líneas de maquinaria exterior

Todas las líneas de conexión deben efectuarse por medio de cables apantallados. La malla de la pantalla debe estar, en una superficie amplia, en conexión con la superficie de la caja del enchufe por ambas caras.

No debe instalarse ninguna conexión paralela a la conexión eléctrica. Si no se puede evitar una conexión paralela, debe observarse una separación mínima de 0,5 metros de la conducción eléctrica.

Temperatura ambiente de la conducción: -15 ... +80 °C.

Sólo está autorizado a conectar aparatos que cumplan los requisitos establecidos para los circuitos de tensión extra-baja de seguridad 'Safety Extra Low Voltage' (SELV). En general, estos serán los que se hayan comprobado según la norma EN 60950/EN 62368-1.

## Instalación de líneas de datos

Los cables de la terminal deben estar íntegramente apantallados y provistos de enchufes con carcasas de metal o metalizadas. Es preciso el uso de cables y enchufes apantallados con el fin de evitar la emisión y recepción de interferencias eléctricas.

Cables permitidos

Cable apantallado:                    4 x 2 x 0,14 mm<sup>2</sup> ( 4 x 2 x AWG 26)  
     6 x 2 x 0,14 mm<sup>2</sup> ( 6 x 2 x AWG 26)  
     12 x 2 x 0,14 mm<sup>2</sup> (12 x 2 x AWG 26)

El cableado de emisión y recepción debe ser de tipo par trenzado apantallado en cada caso.

Longitud máx. del cable:        en la interfaz V 24 (RS232C) - 3 m (con apantallado)  
     en el puerto paralelo - 3 m (con apantallado)  
     en USB - 3 m  
     en la Ethernet - 100 m

## Ventilación por convección

Para evitar un calentamiento indeseado del aparato, el aire debe de circular libremente alrededor del aparato.

## Valores límite

Clase de protección según IP:	20
Temperatura ambiental °C (servicio):	Min. +5 Máx. +35
Temperatura ambiental °C (almacenamiento):	Min. -20 Máx. +60
Humedad relativa del aire % (servicio):	Máx. 80
Humedad relativa del aire % (almacenamiento):	Máx. 80 (no se permite la condensación)

## Garantía

No nos hacemos responsables de ningún daño derivado de:

- Incumplimiento de las condiciones de funcionamiento e instrucciones de uso.
- Instalación eléctrica defectuosa del entorno.
- Modificaciones en la construcción de nuestros aparatos.
- Programación y manejo incorrectos.
- No haber realizado debidamente el aseguramiento de los datos.
- Utilización de repuestos y piezas de recambio no originales.
- Desgaste natural y por uso del aparato.

Cuando reinstale o re programe las impresoras, controle la nueva configuración mediante una prueba de funcionamiento y de impresión. Así evitará efectos, interpretaciones y rotulación equivocados.

Los aparatos deben ser utilizados únicamente por personal debidamente adiestrado al efecto.

Vigile el uso adecuado de nuestros productos y realice a menudo cursillos de formación.

No garantizamos que todos los modelos dispongan de todas las características descritas en este manual. Dado nuestro esfuerzo por un desarrollo y mejora continuados de nuestros productos, cabe la posibilidad de que se modifique algún dato técnico sin comunicarlo previamente.

Debido a la continua mejora de nuestros productos y a las disposiciones específicas para cada país, las imágenes y ejemplos del manual pueden diferir de los modelos suministrados.

Por favor, preste atención a la información acerca de los productos de impresión autorizados, y siga las instrucciones de mantenimiento del aparato para evitar daños y desgaste prematuro del mismo.

Nos hemos esforzado en redactar este manual de manera comprensible para proporcionarle la máxima información posible. Si tuviera cualquier duda o detectara algún error les rogamos nos lo haga saber para que podamos seguir mejorando este manual.

## Desembalaje la impresora

- ⇒ Levante la impresora de etiquetas en la parte inferior y sáquela de la caja.
- ⇒ Controla que la impresora de etiquetas no se haya dañada durante el transporte.
- ⇒ Compruebe que el envío está completo.

## Contenido del material entregado

- Impresora de etiquetas.
- Núcleo de cinta vacío, montado sobre enrollador de cinta de transferencia.
- Borde de rasgado (sólo en los aparatos de base).
- Borde dispensador (sólo aparatos con opción dispensador).
- Cable de corriente.
- Documentación.
- CD con controladores de la impresora.
- Labelstar Office LITE.



### ¡AVISO!

Conserve el embalaje original para un transporte posterior.

## Colocación de la impresora



### ¡PRECAUCIÓN!

Riesgo de desperfectos en el aparato y en el material de impresión debido a la humedad.

- ⇒ Coloque la impresora de etiquetas únicamente en lugares secos y protegidos de salpicaduras de agua.
- ⇒ Coloque la impresora sobre una base plana.
- ⇒ Abre la tapa de la impresora de etiquetas.
- ⇒ Retire las protecciones de espuma para el transporte situadas en el área del cabezal de impresión.

## Conexión de la impresora

La impresora está equipada con un cables de largo alcance. El aparato puede funcionar sin manipulación ninguna con una tensión de red de 110 ... 230 V AC / 50-60 Hz.



### ¡PRECAUCIÓN!

Daño al equipo debido a corrientes de cierre indefinidas.

- ⇒ Antes de conectar a la toma, colocar el enchufe en la posición '0'.
- ⇒ Enchufe el cable de red al casquillo conexión a la red.
- ⇒ Enchufe el cable de red a la toma de corriente puesta a tierra.



### ¡AVISO!

Si la puesta a tierra no es suficiente o no existe, pueden surgir averías durante el funcionamiento. Asegurarse de que todos los ordenadores conectados a la impresora de etiquetas, así como el cable de unión estén puestos a tierra.

- ⇒ Una la impresora de etiquetas con el ordenador o la red de ordenadores con un cable apropiado.

## Puesta en funcionamiento la impresora

Cuando ya se ha realizado todas las conexiones:

- ⇒ Conecte la impresora al interruptor de red.  
Tras conectar la impresora aparecerá el menú principal, en el que se pueden observar el tipo de impresora, y la hora y fecha actuales.
- ⇒ Coloque el material de etiquetas y la cinta de transferencia.
- ⇒ Inicie el proceso de medición en el punto del menú *Configuración etiqueta/Medir etiqueta*.
- ⇒ Pulse la tecla  en teclado de burbuja, se puede finalizar el procedimiento de medición.



### ¡AVISO!

Para posibilitar una medición correcta, deben avanzarse al menos dos etiquetas completas (esto no es válido para las cintas sin fin).

Al realizar la medición de las etiquetas y de la ranura entre etiquetas en la impresora, pueden aparecer diferencias insignificantes. Por esta razón puede introducir también los valores directamente de modo manual en el menú *Configuración etiqueta/Etiqueta y Ranura*.



## Colocación de las etiquetas en modo rasgado

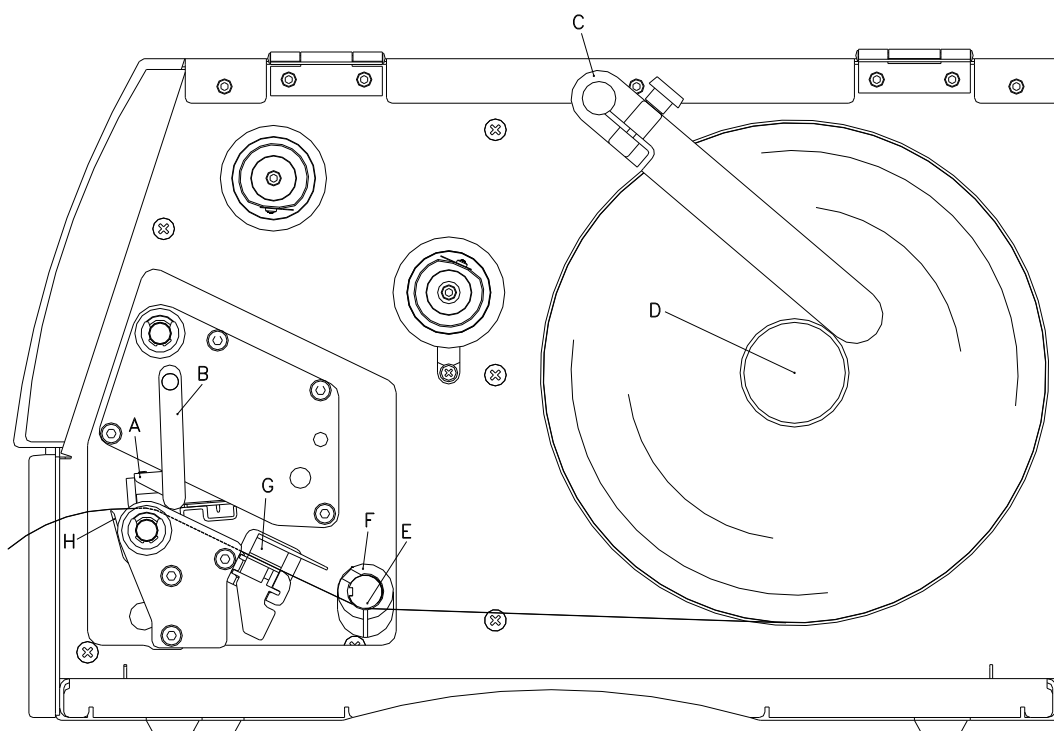

- Levante la tapa de la impresora.
- Gire la palanca roja (F) en el sentido contrario de las agujas del reloj para levantar el cabezal de impresión (G).
- Quite la parte exterior del sujetador-etiquetas (A).
- Coloque el rollo de etiquetas con el dorso de las etiquetas orientado hacia el exterior, en el dispositivo de bobinado (B) y coloque el sujetador-etiquetas (A) de nuevo en la posición inicial.
- Coloque las etiquetas por debajo del eje de retorno (C) y del cabezal de impresión (G). Preste atención al hacerlo a que el material discurra por debajo de la fotocélula (E).
- Para cerrar el cabezal de impresión (G), gire la palanca roja (F) en el sentido de las agujas del reloj, hasta que encaje.
- Delante del cabezal de impresión se encuentra el borde de rasgado (H).
- En el punto del menú *Inicialización/Offset borde rasgado*, pueden regularse los valores del offset.
- Adapte el anillo de ajuste (D) en el eje de retorno (C) al ancho del material.
- Cierre la tapa de la impresora.

## Colocación de la cinta de transferencia



### ¡AVISO!

En el modo de impresión de termotransferencia hay que colocar una cinta de transferencia térmica. Al emplear la impresora para termotransferencia directa, no se colocará ninguna cinta de transferencia térmica. Las cintas de transferencia térmica empleadas en la impresora deben ser al menos tan anchas como el material a imprimir. Si la cinta de transferencia fuera más estrecha que el medio a imprimir, el cabezal de impresión estará parcialmente desprotegido y se desgastará antes de tiempo.

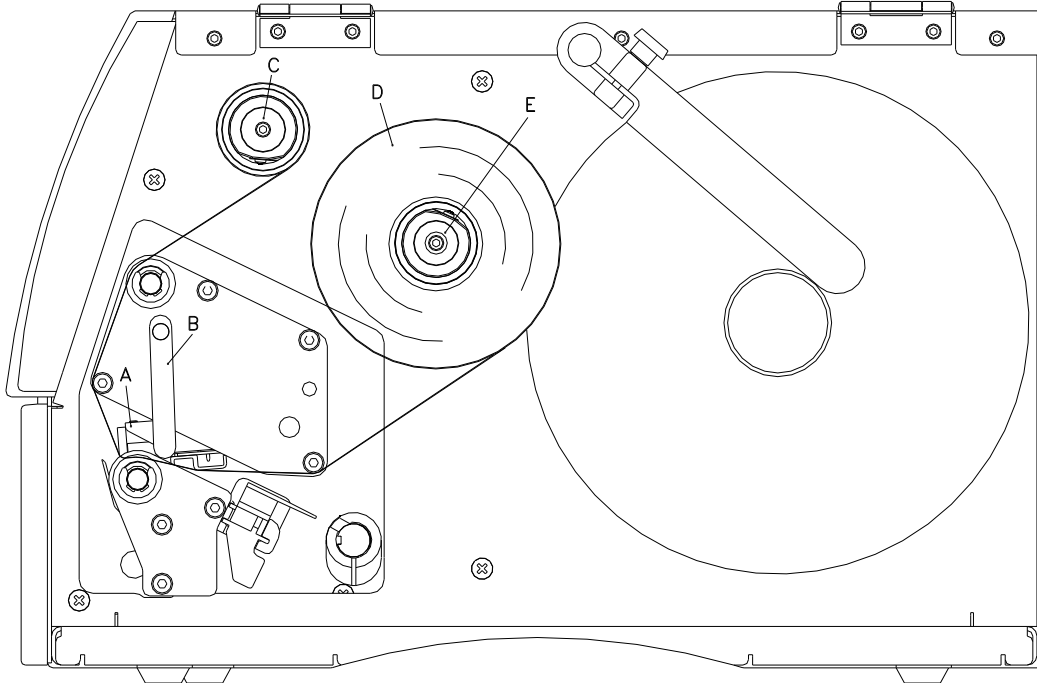

### ¡AVISO!

Antes de colocar una nueva cinta de transferencia, le recomendamos limpiar el cabezal de impresión con el limpiador de cabezal y de rodillos (97.20.002). Deben seguirse las instrucciones de manipulación para la utilización de alcohol isopropílico (IPA). En caso de contacto con la piel o los ojos, enjuagar bien con agua corriente. Si persiste la irritación, acuda a un médico. Asegúrese de que el lugar esté bien ventilado.

- Antes de introducir la cinta de transferencia limpiar el cabezal de impresión.
- Levante la tapa de la impresora.
- Gire la palanca roja (D) en el sentido contrario de las agujas del reloj para levantar el cabezal de impresión (E).



### ¡PRECAUCIÓN!

¡Peligro de raspaduras al colocar la cinta de transferencia o bien al extraer la cinta de transferencia usada!  
⇒ ¡Observe los bordes de la chapa de resorte!

- Deslice el rollo de cinta de transferencia (B) con bobinado hacia el exterior en el rollo de bobinado (C).
- Empuje un rollo vacío de cinta de transferencia en el rollo de bobinado (A) y dirija la cinta por debajo del cabezal (E).
- Fije la cinta en el rollo de bobinado (A), por medio de cinta adhesiva enrollada en el sentido de la rotación del rollo. Durante este proceso debe tenerse en cuenta que la dirección de rotación del enrollador de la cinta de transferencia transcurre en sentido contrario a las agujas del reloj.
- Para cerrar el cabezal de impresión (E), girar la palanca roja (D) en el sentido de las agujas del reloj, hasta que encaje.
- Cierre la tapa de la impresora.



### ¡AVISO!

Debido a que el fino recubrimiento del cabezal térmico de impresión o de otro componente electrónico pueden verse dañados debido a la descarga electrostática, la cinta de transferencia debe ser antiestática. El empleo de material inadecuado puede conducir a fallos de funcionamiento de la impresora y provocará la cancelación de la garantía.



### ¡PRECAUCIÓN!

¡Influencia de material estático sobre las personas!

⇒ Emplee una cinta de transferencia antiestática, debido a que al extraer se pueden producir descargas estáticas.

## Print Settings (Inicialización de impresión)

Secuencia de teclas: , 

### Speed (Velocidad)

Indicación de la velocidad de impresión en mm/s.  
Rango de valores: 50 mm/s ... 200 mm/s (véase los datos técnicos).

### Contrast (Contraste)

Indica el valor de ajuste de la intensidad de impresión cuando se emplean diferentes materiales, velocidades de impresión o contenidos.  
Rango de valores: 10 % ... 200 %

Tecla: 

### Transfer ribbon control (Control de ribbon)

Se comprueba si la cinta de transferencia ha llegado al final, y que la cinta de transferencia no se haya rasgado en el rollo de bobinado.

**Off:** El módulo continúa funcionando sin dar avisos de error.

**On, weak sensibility (sensibilidad baja):** El trabajo de impresión se verá interrumpido, y se mostrará un aviso de error en la pantalla. La impresora reacciona aproximadamente tres veces más lento en el final de la cinta de transferencia (default).

**On, strong sensibility (sensibilidad alta):** El trabajo de impresión se verá interrumpido, y se mostrará un aviso de error en la pantalla. La impresora reacciona inmediatamente al final de la cinta de transferencia.

Tecla: 

### Y displacement (Offset eje Y)

Indicación del desplazamiento del punto cero en mm.  
Rango de valores: -30.0 ... +90.0

Tecla: 

### X displacement (Offset eje X)

Desplazamiento de la impresión en sentido transversal a la dirección del papel.  
Rango de valores: -90.0 ... +90.0

Tecla: 

### Tear-off offset (Borde de rasgado)

Indica el valor de la distancia de desplazamiento de la etiqueta hacia adelante en el proceso de impresión, y, al proceder a imprimir una nueva etiqueta, la etiqueta ya impresa se desplazará de nuevo hacia atrás, hasta el inicio de la etiqueta a imprimir.

Rango de valores: 0 ... 50.0 mm  
Estándar: 12 mm.

## Label Layout (Configuración etiqueta)

Secuencia de teclas: , , 

### Label length (Largo de etiqueta)

Indicación del largo de etiqueta en mm.  
Altura mínima aconsejada: 5 mm (alimentador 25 mm).

### Gap length (Largo de ranura)

Indicación de la distancia entre dos etiquetas en mm.  
Valor mínimo aconsejado: 1 mm.

Tecla: 

### Column printing (Impresión en varias columnas)

Introduce el ancho de una etiqueta así como cuántas etiquetas una al lado de la otra hay en el material de etiquetas.

Tecla: 

### Measure label (Medición de etiqueta)

Iniciar la operación de medición con la tecla .

Tecla: 

### Label type (Tipo etiqueta)

Por defecto están seleccionadas las etiquetas adhesivas. Pulse la tecla , para seleccionar las etiquetas sin fin.

Tecla: 

### Material selection (Selección de material)

Selección de los diseños o del material de las cintas de transferencia, respectivamente.

Tecla: 

### Photocell (Fotocélula)

Selección de la fotocélula empleada. Se dispone de las siguientes opciones: fotocélula con transmisión normal, fotocélula con reflexión normal, fotocélula con transmisión inversa, fotocélula con reflexión inversa y fotocélula de luz ultrasónica (opción).

### Scan position (Scan position)

Con ayuda de esta función se puede insertar el largo porcentual de una etiqueta, conforme al cual se buscará el final de la etiqueta. Aquí se pueden sortear las marcas existentes en la etiqueta.

Tecla: **Label error length  
(Fallo de largo de etiqueta)**

Señala tras cuántos mm, en caso de que ocurra un error, se mostrará en pantalla un aviso de error.  
Valores posibles: 1 mm ... 999 mm.

**Synchronization  
(Sincronización)**

**On:** Si faltara una etiqueta en el material de soporte, se mostrará un aviso de error en pantalla.  
**Off:** Si faltan etiquetas esto se ignorará, o sea, que se imprimirá en la ranura.

Tecla: **Flip label  
(Etiqueta espejo)**

El eje de volteo se encuentra en el centro de la etiqueta. Si el ancho de la etiqueta no ha sido transmitido al impresora, se utiliza la etiqueta predefinida, es decir, el ancho del cabezal de la impresión. Por este motivo deberá asegurarse de que la etiqueta sea tan ancha como el cabezal de impresión. De otro modo se podrían dar problemas al llevar a cabo el encuadramiento.

Tecla: **Rotate label  
(Girar etiqueta)**

La etiqueta se imprimirá de forma estándar con un giro. Si se activa esta función, la etiqueta se girará 180° y se imprimirá en el sentido de la lectura.

Tecla: **Rotate label in degrees  
(Girar etiqueta en °)**

Se corresponde con el parámetro *Girar etiqueta*, la etiqueta puede girarse en incrementos de 90°.

**¡AVISO!**

Sólo se pueden rotar objetos residentes en la memoria interna (texto, líneas y códigos de barras). No se pueden rotar gráficos.

Tecla: **Alignment  
(Alineamiento)**

El alineamiento de la etiqueta se realiza después del giro/volteo, es decir el alineamiento es independiente del giro y el volteo.

**Left (Izquierda):** La etiqueta se ajustará al margen izquierdo del cabezal de impresión.

**Centre (Centro):** La etiqueta se ajustará al punto medio del cabezal de impresión (centrado).

**Right (Derecha):** La etiqueta se ajustará al margen izquierdo del cabezal de impresión.

**Device Settings (Parámetros del aparato)**Secuencia de teclas:  , , **Field handling  
(Administración de campos)**

**Off:** La memoria del módulo se anula por completo.

**Keep graphic (Grabar gráfico):** Un gráfico o una fuente True Type se enviarán respectivamente sólo una vez al módulo de impresión, y quedarán almacenados en la memoria interna del módulo de impresión. En las siguientes órdenes de impresión sólo se transmitirán los datos modificados a el módulo. La ventaja aquí es el ahorro de tiempo en la transmisión de los gráficos. Los datos gráficos generados por el propio módulo (escritos internos, códigos de barra...) sólo se generan si son modificados. Aquí se ahorra tiempo de generación.

**Delete graphic (Borrar gráfico):** Los gráficos o fuentes True Type grabados en la memoria interna del módulo se borrarán, pero el resto de los campos no.

**Restore graphic (Restaurar gráfico):** Tras finalizar un trabajo de impresión se puede reiniciar nuevamente en la impresora el pedido de impresión. Todos los gráficos y las fuentes TrueType se imprimen nuevamente.

**¡AVISO!**

**Excepción:** En impresión de multibanda siempre se tienen que imprimir bandas completas (cantidad siempre múltiplos de las bandas). Las bandas borradas no se restauran.

Tecla: **Codepage  
(Codepage)**













Muestra la fuente empleada por la impresora. Tiene la posibilidad de seleccionar los siguientes: Codepage 437, Codepage 850, Codepage 852, Codepage 857, Codepage 1250, Codepage 1251, Codepage 1252, Codepage 1253, Codepage 1254, Codepage 1257, WGL4. Le agradecemos que busque las tablas referidas a los códigos arriba mencionados en [www.valentin-carl.es/Descargas](http://www.valentin-carl.es/Descargas).

Tecla: **External parameters  
(Parámetros externos)**

**Label dimension only (Sólo dimensión de la etiqueta):** Los parámetros de la longitud de la etiqueta, longitud de espacio entre etiquetas y ancho de etiquetas se pueden transferir a la impresora. Todos los demás ajustes se pueden hacer directamente en la impresora.

**On:** Existe la posibilidad, de introducir mediante nuestro software de etiquetas parámetros tales como la impresión y el contraste en la impresora. En este caso, los parámetros insertados directamente en la impresora no se tienen en cuenta.

**Off:** Sólo se tendrán en cuenta los parámetros introducidos directamente en la impresora.

Tecla: 	
<b>Buzzer (Zumbador)</b>	<b>On:</b> Al pulsar cualquier tecla se produce una señal acústica. <b>Rango de valores:</b> 1 ... 7. <b>Off:</b> Sin señal acústica
<b>Display (Pantalla)</b>	Ajuste del contraste en pantalla. <b>Rango de valores:</b> 45 ... 75.
Tecla: 	
<b>Language (Idioma)</b>	Selección del idioma en el que se mostrará el texto de la pantalla. Por el momento, tiene la posibilidad de seleccionar alemán, inglés, francés, finés, checo, portugués, holandés, italiano, danés, polaco, griego, húngaro, ruso, chino (opción), ucraniano, turco, sueco, noruego, estonio.
Taste: 	
<b>Keyboard (Asignación del teclado)</b>	Selección de la asignación de teclas en su teclado. Por el momento, tiene la posibilidad de optar entre Alemania, Inglaterra, Francia, Grecia, España, Suecia, EEUU e Rusia.
Tecla: 	
<b>Customized entry (Entrada personalizada)</b>	<b>Off (apagada):</b> En la pantalla no aparece ninguna pregunta acerca de variables personalizadas. En este caso se imprimirá teniendo en cuenta los valores predeterminados por defecto. <b>On (conectada):</b> Al iniciar la impresión aparece en la pantalla una vez una pregunta acerca de variables personalizadas. <b>Auto (automática):</b> Las preguntas por la variable personalizada y la cantidad aparecen tras cada boceto. <b>Auto without quantity query (automática sin consulta de cantidad):</b> La pregunta por la variable personalizada aparece tras cada boceto sin una consulta adicional por la cantidad.
Tecla: 	
<b>Hotstart (Hotstart)</b>	<b>On:</b> Es posible reanudar un trabajo de impresión interrumpido, al conectar de nuevo la impresora. <b>Off:</b> Tras desconectar la impresora, se borran todos los datos.
Tecla: 	
<b>Autoload (Carga automática)</b>	<b>On:</b> Una etiqueta que ha sido cargado una vez de la tarjeta Compact Flash puede volver a cargarse automáticamente después de arrancar de nuevo la impresora. Después de la nueva conexión de la impresora se carga siempre la última etiqueta de la tarjeta Compact Flash. <b>Off:</b> Después de encender de nuevo la impresora debe cargarse la última etiqueta utilizada manualmente desde la tarjeta Compact Flash.
Tecla: 	
<b>Manual reprint (Reimpresión manual)</b>	<b>Yes (Sí):</b> En el caso de que la impresora se encuentre en el Modo stop, debido a, p.ej. un fallo, puede reimprimirse de nuevo la última etiqueta impresa con la ayuda de las teclas  y  . <b>No (No):</b> Se avanzarán sólo etiquetas vacías.
Tecla: 	
<b>Backfeed/Delay (Realimentación/Retardo)</b>	<b>Backfeed (Realimentación):</b> La realimentación está optimizada en los modos de dispensado (opcional) y cortador (opcional). Ahora, cuando se hace un offset, la etiqueta siguiente se "preimprime" siempre y cuando sea posible y por lo tanto la realimentación de la etiqueta no es necesaria y de esta manera se ahorra tiempo. <b>Delay (Retardo):</b> El tiempo de deceleración ajustable está solo disponible y es importante para el modo <i>Realimentación automática</i> .
Tecla: 	
<b>Confirm label change (Confirmar cambios en la etiqueta)</b>	<b>On:</b> Una nueva orden de impresión se imprime recién después de la confirmación en el aparato. Una orden de impresión continua ya activa se continúa imprimiendo hasta que se efectúa la confirmación en el aparato. <b>Off:</b> No aparece consulta alguna en la pantalla del direccionamiento.
Tecla: 	
<b>Standard label (Etiqueta estándar)</b>	<b>On:</b> Si se comienza una orden de impresión sin haberla definido previamente, se imprime por defecto la etiqueta estándar. <b>Off:</b> Si se comienza una orden de impresión sin haberla definido previamente, aparece un mensaje de error.

Tecla: **Synchronization at switching on (Sincronización en el encendido)****Off:** Desactiva la sincronización, p.ej. la medición y alimentación de etiquetas deben efectuarse de manera manual.**Measure (Medir):** Tras conectar la impresora se mide automáticamente la etiqueta.**Label feed (Avance de etiqueta):** Después de encender la impresora la etiqueta avanza para que la impresión esté ajustada a la etiqueta. Puede que avance una o más etiquetas.Tecla: **CMI length (Longitud CMI)**

Si se interrumpe la impresión de la etiqueta, puede suceder que haya una mínima discontinuidad de la impresión por parte del cabezal, mostrando una fina línea blanca en la etiqueta impresora. Para evitar esto, se puede ajustar un movimiento de realimentación muy pequeño (0 - 1 mm) en el cual la etiqueta se mueve hacia atrás. En la siguiente impresión, se imprime todo el rango de nuevo. El ajuste del largo del CMI solo influirá en la selección del modo de realimentación "realimentación optimizada".

**Network (Red)**Secuencia de teclas: , , , , 

Encontrará más información acerca de esta menú en un manual independiente.

**Password (Contraseña)**Secuencia de teclas: , , , , , **Operation (Operación)****Password (Contraseña)** Introduzca una contraseña numérica de 4 dígitos.Tecla: **Protection configuration (Protección configuración)** Los ajustes de la impresora se pueden modificar (contraste, velocidad, modo de funcionamiento,...). El bloqueo mediante contraseña evita las modificaciones en los ajustes de la impresora.Tecla: **Protection favorites (Protección por contraseña favoritos)** La protección por contraseña impide el acceso al menú favoritos.Tecla: **Protection memory card (Protección tarjeta de memoria)** Mediante las funciones de la tarjeta CF se pueden grabar etiquetas, cargarlas, etc. Aquí se debe distinguir al establecer una protección con contraseña, si se permite acceso a la lectura o ningún acceso.**No protection:** No password protection**Userview only:** Only reading access**Protected:** Access blockedTecla: **Protection printing (Protección impresión)** En caso de que la impresora esté conectada a un PC, puede resultar útil que el usuario no pueda imprimir manualmente. De esta manera, la protección con contraseña reviene que se imprima manualmente.**Network (Red)****Password (Contraseña)** Introduzca una contraseña con 15 dígitos. La contraseña puede contener letras, números y caracteres especiales.Tecla: **Protection HTTP (Passwortschutz HTTP)** La comunicación mediante HTTP queda bloqueada.Tecla: **Protection Telnet (Protección Telnet)** No se podrán cambiar los ajustes del servicio Telnet.

Tecla: **Protection remote access  
(Protección acceso remoto)**

La protección por contraseña previene que se controle la impresora remotamente.

**¡AVISO!**

Para volver a activar una función bloqueada, debe introducir de nuevo la contraseña. Si se ha introducido correctamente, podrá ejecutar la función deseada.

**Interface (Puertos)**Secuencia de teclas:        **COM1 / Baud / P / D / S****COM1:**

0 - Puerto serial desconectado (Off)  
 1 - Puerto serial conectado (On)  
 2 - Puerto serial conectado (On); no se origina ningún aviso en caso de un error de transmisión.

**Baud rate (Baudios):**

Indicación del número de Bits que se transmitirán por segundo.  
 Pueden elegirse los siguientes valores: 2400, 4800, 9600, 19200, 38400, 57600 y 115200.

**P = Parity (Paridad):**

N – Ninguna; E – Par; O - Impar  
 Debe asegurarse de que la configuración coincide con la de la impresora.

**D = Data bits (Bits de datos):**







Configuración de los bits de datos. Puede elegir entre 7 o 8 Bits.

**S = Stop bit (Bits de paro):**

Puede elegir 1 o 2 bits de paro. Indicación de los bits de paro entre los Bytes.

Tecla: **Start/stop sign  
(Señal Inicio/Parada)****SOH:** Inicio del bloque de transmisión de datos → HEX formato 01**ETB:** Final del bloque de transmisión de datos → HEX formato 17Tecla: **Data memory  
(Memoria de datos)****Standard (Estándar):** Tras el inicio de un trabajo de impresión se archivarán datos en el buffer de la impresora hasta que éste se llene.**Advanced (Extendida):** Durante la ejecución de una trabajo de impresión, los datos se siguen recibiendo y transformando.**Off:** Tras el inicio de un trabajo de impresión, la impresora no recibirá más datos.Tecla: **Port test  
(Test de puertos)**

Compruebe si se transfieren datos a través del puerto.

Pulse las teclas  y  para seleccionar General (On). Pulse la tecla  y se imprimirán los datos que se envíen a través del puerto que se desee (COM1, LPT, USB, TCP/IP).**Emulation (Emulación)**Secuencia de teclas:         **Protocol  
(Protocolo)****CVPL:** Carl Valentin Programming Language**ZPL:** Zebra® Programming LanguageCon las teclas  y  se puede seleccionar el protocolo. Pulse la tecla  para confirmar la selección. La impresora realiza un arranque nuevo y las instrucciones ZPL II® son transformadas internamente por la impresora en instrucciones CVPL, y ejecutadas posteriormente por la impresora.Tecla: **Printhead resolution  
(Resolución de cabezal de impresión)**

En caso de emulación ZPL II® activa hay que ajustar la resolución del cabezal de impresión de la impresora emulada.

**¡AVISO!**

Si la resolución del cabezal de impresión de la impresora Zebra® se diferencia de la resolución del aparato Valentin, entonces el tamaño de los objetos no coincide exactamente (p. Ej. textos, graficas).

Tecla: **Drive mapping  
(Asignación platina)**







El acceso a las unidades de disco Zebra® es desviado hacia la unidad de disco Valentín correspondiente.

**¡AVISO!**

Debido a que los Fonts internos del módulo de impresión directa contenidos en la impresora Zebra® no existen en el aparato Valentín, pueden aparecer leves diferencias en el aspecto de la escritura.

Tecla: **PJL – Printer Job  
Language  
(PJL – Idioma de trabajo  
de impresión))**

Indica información del estado de la orden de impresión.

**Date & Time (Fecha & Hora)**Secuencia de teclas: , , , , , , , , , **Set date/time  
(Modificar fecha y hora)**La fila superior de la pantalla muestra la fecha actual, la fila inferior la hora actual. Con ayuda de las teclas  y  se puede acceder al campo siguiente en cada caso, para modificar los valores mostrados con las teclas  y  al alza o a la baja.Tecla: **Summertime  
(Horario de verano)****On:** La impresora cambia automáticamente al horario de invierno y de verano.  
**Off:** El horario de verano no se reconoce ni se aplica automáticamente.Tecla: **Start of summertime -  
formato  
(Formato inicio horario de  
verano)**Selección del formato para insertar la fecha de comienzo del horario de verano.  
DD = Día; WW = Semana; WD = Día de la semana; MM = Mes; YY = Año  
next day = se contará a partir del día siguienteTecla: **Start of summerime -  
fecha  
(Fecha inicio del horario  
de verano)**

Inserción de la fecha de comienzo del horario de verano. Esta inserción se refiere al formato anteriormente seleccionado.

Tecla: **Start of summerime - hora  
(Hora inicio del horario de  
verano)**

Con ayuda de esta función puede usted insertar la hora en la que debe comenzar el horario de verano.

Tecla: **End of summertime -  
format  
(Formato de fin del horario  
de verano)**

Selección del formato para determinar el final del horario de verano.

Tecla: **End of summertime -  
fecha  
(Fecha del fin del horario  
de verano)**

Inserción de la fecha en la que debe finalizar el horario de verano. La inserción se refiere al formato anteriormente seleccionado.

Tecla: **End of summertime -  
horario  
(Fin del horario de verano)**

Inserción de la hora en la que debe terminar el horario de verano.

Tecla: **Time shifting  
(Diferencia horaria)**

Indica la diferencia horaria establecida entre el horario de verano y de invierno en horas y minutos.



## Service Functions (Funciones de asistencia técnica)



### ¡AVISO!

Para que el distribuidor o el fabricante de la impresora pueda intervenir con rapidez en caso de que se necesite asistencia técnica, la impresora dispone del menú Funciones de asistencia técnica. La impresora puede leer directamente la información necesaria, por ejemplo los parámetros configurados. Otras indicaciones como versión del programa (Firmware) o fuentes pueden tomarse del menú principal.

Secuencia de teclas: **F**, , , , , , , , , , 

#### Label parameters (Parámetros de etiquetas)

Indicación de los parámetros de etiquetas en voltios.

**A:** Indicación del valor mínimo.

**B:** Indicación del valor máximo.

**C:** Indicación del valor de umbral de conmutación. Se verifica durante la medición y puede modificarse.

Tecla: 

#### Photocell configuration (Ajustes de la fotocélula)

Esta función posibilita el ajuste del nivel de la fotocélula.

En el caso de que surgieran problemas en el posicionamiento o en la medición de las etiquetas, se puede regular el nivel de la fotocélula de etiquetas manualmente. Preste atención al hacerlo a que esté regulado el mayor hub posible (para etiquetas >3 V, para la ranura <1 V).

Tecla: 

#### Photocell parameters (Parámetros de la fotocélula)

**TLS:** Indicación del nivel de la barrera óptica de luz pasante en voltios.

**RLS:** Indicación del nivel de la barrera óptica reflectante en voltios.

**SLS:** Indicación del nivel de la barrera óptica dispensado en voltios.

**RC:** Indicación del estado de la barrera óptica de la cinta impresora en voltios (0 ó 1).

**H:** Indicación del valor 0 ó 1 para la posición del cabezal de impresión.

0 = Cabezal de impresión abajo

1 = Cabezal de impresión arriba

Tecla: 

#### Paper counter (Contador papel)

**D:** Muestra el recorrido en metros efectuado hasta ahora por el cabezal de impresión.

**G:** Muestra el recorrido en metros realizado por el aparato.

Tecla: 

#### Heater resistance (Resistencia calentadora)

Para obtener una impresión de calidad, al cambiar el cabezal de impresión debe instalarse el valor en ohmios indicado.

Tecla: 

#### Printhead temperature (Temperatura del cabezal de impresión)

Muestra la temperatura del cabezal de impresión. La temperatura será normalmente la misma que la temperatura ambiente. Pero si aumenta la temperatura máxima en el cabezal de impresión, el trabajo de impresión en curso se interrumpirá y se mostrará un mensaje de error en la pantalla de la impresora.

Tecla: 

#### Motor ramp (Motor Rampa)

Cuanto más alto esté regulado el valor '+' más lento acelerará el motor de avance. Cuanto más bajo esté regulado el valor '-' más rápido se frenará el motor avance.

Tecla: 

#### Print examples (Ejemplos de impresión)

Se imprimen todos los ajustes del módulo.

##### Settings (Informe de estatus):

Imprime todos los parámetros del módulo, como p.ej. velocidad, etiquetas, cinta de transferencia, etc.

##### Bar codes (Códigos de barra):

Se imprimen todos los códigos de barra disponibles en el módulo.

##### Fonts (Fuentes):

Imprime todas las fuentes vectoriales y bitmap.

Tecla: 

#### Input (Entradas)

Indicación del nivel de señal de entrada

0 = Low (bajo)

1 = High (alto)

Tecla: 

#### Output (Salidas)

Indicación del nivel de señal de salida.

0 = Low (bajo)

1 = High (alto)

Tecla: **I/O status  
(Estado E/S)**

Se cuentan los acontecimientos relevantes y se registran en la memoria RAM. El registro se pierde después de desconectar el aparato.

**RInt** = Interrupciones reales

Los impulsos de entrada de inicio se cuentan directamente en la interrupción.

**Dbnc** = Debounced--> Retardo

Se cuentan los impulsos de entrada de inicio que son más largos que el retardo programado. Solo estos impulsos de inicio puede dar a una impresión. Si un impulso de inicio es demasiado corto, no se efectúa ninguna impresión. Esto se puede reconocer por el hecho de que RInt cuenta y el Dbnc no.

**NPPrn** = No imprime

Se cuentan los impulsos de entrada de inicio que no han sido impresos. Causas: no hay una orden activa de impresión, la impresión se ha detenido (manualmente o debido a un error) o el sistema de impresión está aún activo debido a que sigue procesando una orden de impresión.

**PrtStrtReset** = Los contadores se ponen a 0.

**PrtStrtTime** = Mide la longitud de la última impresión en ms.

Tecla: **Cutter photocell  
(Cortador fotocélula)**

1 = La impresora está equipada con un cortador.

0 = La impresora no está equipada con un cortador

**Cutter Home (CH)  
(Cortador Home (CH))**

1 = El cortador se encuentra en la posición inicial, preparado para iniciar el proceso de corte.

0 = El cortador no se encuentra todavía en la posición inicial. Antes de iniciarse un procedimiento de cortado, primero debe colocarse el cortador en la posición inicial.

Tecla: **Online/Offline  
(Online/Offline)**

Esta función se activa, por ejemplo, cuando hay que cambiar la cinta de impresión. Se impide el procesamiento de una orden de impresión, no obstante, no estar aún listo el aparato. Si la función está activada, puede cambiarse entre el modo online y offline con la tecla . En la pantalla se visualiza el estado respectivo (Standard: Apagada).

**Online:** Pueden recibirse datos a través de interfaces. Las teclas de la laminilla de teclado están activadas únicamente cuando se cambió al modo offline con la tecla .

**Offline:** Las teclas de la laminilla de teclado están nuevamente activadas, pero los datos recibidos ya no se procesan. Cuando el aparato está nuevamente en el modo online, también se reciben otra vez nuevas órdenes de impresión.

Tecla: **Transfer ribbon advance  
warning  
(Aviso próximo fin de  
cinta)**

**TRB = Transfer ribbon advance warning (Aviso próximo fin de cinta):**

Al seleccionar esta función, aparecerá una señal de aviso vía control output, antes de que la cinta de transferencia llegue a su fin.

**Warning diameter (Aviso próximo de diámetro fin de cinta):**

Ajuste del preaviso de diámetro (mandril) de la cinta de transferencia.

Si en este punto se inserta un valor en mm., al alcanzarse este diámetro (medido en el rollo de la cinta de transferencia), se mostrará una señal a través del control de salida.

**Ribbon advance warning mode (Modo del aviso próximo fin de cinta):**

**Warning (Atención):** Cuando se alcance el diámetro de aviso se activará la salida correspondiente en el Puerto E/S.

**Reduced print speed (Velocidad de impresión reducida):** Velocidad en la que la velocidad de impresión está reducida.

**Error (Error):** La impresora se detiene cuando se alcance el diámetro establecido y se muestra el siguiente mensaje 'poco ribbon'.

**Reduced print speed (Velocidad de impresión reducida):**

Ajuste de la velocidad de impresión reducida en mm/s. Debe ajustarse dentro de los límites de la velocidad de impresión normal.

Tecla: **Zero point adjustment  
in Y direction  
(Ajuste de punto cero en  
dirección Y)**

Se indica en valores de 1/100 mm.

Después de sustituir el cabezal, si la impresión no puede continuarse en la misma posición en la etiqueta, la diferencia puede ser corregida en la dirección de impresión.

**¡AVISO!**

El valor de la alineación de punto cero se establece de fábrica. Después de cambiar el cabezal, sólo se le permite al personal de SAT establecer de nuevo este valor.

Tecla: **Zero point adjustment  
in X direction  
(Ajuste de punto cero en  
dirección X)**

Se indica en valores de 1/100 mm.  
Después de sustituir el cabezal, si la impresión no puede continuarse en la misma posición en la etiqueta, la diferencia puede ser corregida de manera transversal en la dirección de impresión.

**¡AVISO!**

El valor de la alineación de punto cero se establece de fábrica. Después de cambiar el cabezal, sólo se le permite al personal de SAT establecer de nuevo este valor.

Tecla: **Print length +/-  
(Largo de impresión +/-)**

Indica la corrección de la máscara de impresión en porcentaje.  
Debido a influencias mecánicas (p.ej. tamaño del rollo de etiquetas) la máscara de impresión puede verse aumentada o disminuida en relación a su tamaño original.  
Rango de valores +10.0 % ... -10.0 %

Tecla: **Write log files on MC  
(Escribir archivo histórico  
en la tarjeta de memoria)**

Con este comando, se guardan los archivos históricos en un medio de almacenamiento adecuado (tarjeta de memoria). Después de que aparezca el mensaje 'Terminado' (Finish) se puede retirar el medio de almacenamiento.

Los archivos se guardan en el directorio 'log':

**LogMemErr.txt:** Los errores se guardan con información adicional como fecha/hora y el nombre de archivo/número de línea (para desarrolladores).

**LogMemStd.txt:** Se guardan los eventos seleccionados.

**LogMemNet.txt:** Se envían los últimos datos a través del puerto 9100.

**Parameters.log:** Todos los parámetros de la impresora de manera legible.

**TaskStatus.txt:** Estado de todas las tareas de la impresora.

**Main Menu (Menú principal)**

Encienda la impresora y la pantalla mostrará el menú principal. El menú principal muestra información tal como tipo de impresora, fecha y hora, número de la versión del firmware y el tipo de FPGA.

Esta información se muestra durante un breve período de tiempo, luego vuelve a la primera información.

Pulse la tecla  para mostrar la información siguiente en la pantalla.

## Tarjeta de Memoria Compact Flash / Memoria USB\*

El menú de acceso a la memoria de las tarjetas se opera a través de las teclas del teclado que hay en la impresora o mediante un teclado externo USB.

		Retrocede al menú anterior.
		Función <i>Load layout</i> (Cargar diseño): Cambia al explorador de archivos. File Explorer (Explorador de Archivos): Cambia al context menu (menú contextual).
		Selecciona un archivo/directorio siempre que sea posible una selección múltiple.
		Menú principal: Acceso al menú de la memoria. File Explorer (Explorador de Archivos): Crear un nuevo archivo.
		Inicia la función actual para el directorio o archivo activo.
		Cambia el directorio subordinado.
		Cambia el directorio marcado actual.
		Avanza hacia arriba la página en el directorio actual.
		Avanza hacia abajo la página en el directorio actual.

### Define user directory (Definir directorio del usuario)

Define el directorio estándar en el ue se almacenan los archivos para su posterior procesamiento.



#### ¡AVISO!

Define un directorio del usuario:

- antes de usar y/o navegar por el menú de la memoria.
- si el formateo de la tarjeta CF se ha hecho en un PC y por tanto el directorio STANDARD no se ha creado automáticamente.

```
File Explorer
A:\
[Drives]
-><STANDARD>
<DIR_1>
```

```
Context Menu
A:
->Set as user dir
Format
Copy
```



Acceso al menú de la memoria



Llamada al File Explorer (explorador de archivos).



Selecciona el directorio.



Lista de todas las funciones disponibles.



Seleccione la función *Set as user dir* (Configurar como directorio de usuario).



Confirma la selección.



Vuelta al menú principal.

Cuando vuelva a iniciar el menú de la memoria se mostrará el directorio seleccionado como directorio de usuario.

### Load layout (Cargar diseño)

Carga una etiqueta del directorio definido por el usuario. Esta función permite un rápido acceso a la etiqueta deseada porque se muestran solo las etiquetas y se ocultan los directorios.

```
Load layout
A:\STANDARD
->File_name1.prn
File_name2.prn
File_name3.prn
File_name4.prn
```



Acceso al menú de la memoria



Selecciona una etiqueta.



Confirma la selección.



Selecciona el número de etiquetas que van a ser impresas.

La impresora muestra automáticamente la ventana para elegir el número de copias que se desean imprimir.



Inicio de la orden de impresión.



#### ¡AVISO!

El directorio NO PUEDE cambiarse aquí. Un cambio de directorio DEBE hacerse en el Explorador de Archivos con la función *Change directory* (Cambiar directorio).

\* no disponible

## File Explorer (Explorador de Archivos)

El Explorador de Archivos es el gestor de archivos del sistema de impresión. El Explorador de Archivos proporciona las funciones principales para que el usuario acceda al menú de la memoria.

En el directorio del usuario, pulse la tecla **F** para acceder al Explorador de Archivos. Están disponibles las siguientes opciones:







- Cambiar unidad y/o directorio
- Cargar diseño
- Memorizar etiqueta y/o configuración
- Borrar archivo(s)
- Formatear la tarjeta CF
- Copiar archivo(s)

### Change drive/directory (Cambiar unidad y/o directorio)

```
File Explorer
A:\
[Drives]
-><STANDARD>
<DIR_1>

File Explorer
A:\STANDARD\
-><..>
layout01
layout02
```





Selecciona la unidad o el directorio en que se guardan los archivos.

-  Acceso al menú de la memoria
- F** Llamada al File Explorer (explorador de archivos).
- ,  + ,  Selecciona el directorio.
-  Confirma la selección.  
Se muestra el directorio seleccionado.

### Load file (Cargar archivo)

```
Load file
A:\STANDARD\
<..>
->layout01
layout02
```

Carga un archivo. Este puede ser una configuración, un diseño, etc.

-  Acceso al menú de la memoria
- F** Llamada al File Explorer (explorador de archivos).
-  +  Selecciona el archivo.
-  Se carga el archivo seleccionado.







### ¡AVISO!

Si el archivo seleccionado es un diseño, entonces puede introducir inmediatamente el número de copias a imprimir.

### Save layout (Memorizar diseño)

```
Save file
A:\STANDARD
->Save layout
Save config.
noname
```

Guarda el diseño en memoria bajo el nombre seleccionado.





-  Acceso al menú de la memoria
- F** Llamada al File Explorer (explorador de archivos).
-  Cambia al menú *Save file* (Guardar archivo).
- ,  Selecciona la función *Save label* (Memorizar diseño).
-  Confirma la selección

Si está conectado un teclado USB puede asignarse un nuevo nombre de archivo para *noname*.

**Save configuration  
(Memorizar configuración)**

```
Save file
A:\STANDARD
Save layout
→ Save config.
config.cfg
```

Memoriza la configuración del aparato bajo un nuevo nombre.

-  Acceso al menú de la memoria
-  Llamada al File Explorer (explorador de archivos).
-  Cambia al menú *Save file* (Guardar archivo).
-  Seleccione la función *Save configuration* (Memorizar configuración).
-  Confirma la selección







Si está conectado un teclado USB puede asignarse un nuevo nombre de archivo para *config.cfg*.

**Delete file  
(Borrar archivo)**

```
File Explorer
A:\STANDARD\
 layout01 *
→ layout02 *
 layout03
 layout04

Context menu
2 objects marked
→ Delete
Copying
```

Elimina uno o más archivos o directorios irrevocablemente. Con el borrado de un directorio se borran también los archivos y subdirectorios que contuviera.

-  Acceso al menú de la memoria
-  Llamada al File Explorer (explorador de archivos).
-  Selecciona el archivo.
-  Marca los archivos que van a ser borrados. Los archivos se marcan con un\*. Repita este procedimiento hasta que marque todos los archivos o directorios que desee.
-  Cambia al 'context menu' (menú contextual).
-  Seleccione la función *Delete file* (Borrar archivo).
-  Confirma la selección

**Formatting  
(Formatear)**

Fomatea de manera irreversible la tarjeta de memoria.









**¡AVISO!**

¡Las memorias USB no pueden formatearse en la impresora!

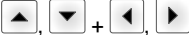
```
File Explorer
DRIVES
→ A: 954Mb free
U: No media

Context menu
A:\
Set as user dir
→ Formatting
Copy
```

-  Acceso al menú de la memoria
-  Llamada al File Explorer (explorador de archivos).
-  Seleccione la unidad que va a formatear.
-  Cambia al 'context menu' (menú contextual).
-  Seleccione la función *Formatting* (Formatear).
-  Confirma la selección

**Copying (Copiar)**

```
File Explorer
A:\STANDARD\
layout01 *
→ layout02 *
layout03
layout04
```

```
Context menu
2 objects marked
Delete
→ Copying
```

```
Select Destination
DRIVES
→ A: 954Mb free
```

Creates a duplicate of the original file and/or the original directory to make changes independently of the original. Crea un duplicado del archivo original o directorio para hacer cambios independientes al original.



Acceso al menú de la memoria



Llamada al File Explorer (explorador de archivos).



Selecciona el archivo.



Marca los archivos que van a ser borrados. Los archivos se marcan con un \*. Repita este procedimiento hasta que marque todos los archivos o directorios que desee.



Cambia al 'context menu' (menú contextual).

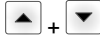

Selecciona la función Copying (Copiar).



Especifica el objetivo del procedimiento de copia.

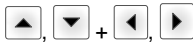

Selecciona el objetivo de almacenamiento



Confirma la selección

**Filtro:**

**Solo posible con un teclado USB conectado**

Para ciertas funciones hay que guardar una mascara de filtro o un nombre de archivo. Esta entrada se indica en la ruta. Es posible que con el filtro de mascara buscar ciertos archivos. Por ejemplo, con la entrada "L" solo se listan los archivos cuyas cadenas de caracteres comienzan con "L" (sin distinción de mayúsculas o minúsculas).

**Sin filtro**

```
Load layout
A:\STANDARD
→ First_file.prn
Layout_new.prn
Sample.prn
12807765.prn
```

**Con filtro**

```
Load layout
L
→ Layout_new.prn
```

**Datos técnicos**

	Vita II 103/8 T	Vita II 104/8	Vita II 106/12	Vita II 106/24	Vita II 108/12 T
Resolución	203 dpi	203 dpi	300 dpi	600 dpi	300 dpi
Velocidad máx. de impresión	200 mm/s	200 mm/s	150 mm/s	100 mm/s	150 mm/s
Ancho de impresión	104 mm	104 mm	105,7 mm	105,7 mm	108,4 mm
Ancho máx. de etiqueta					
Estándar	116 mm	116 mm	116 mm	116 mm	116 mm
Modo cortado	112 mm	112 mm	112 mm	112 mm	112 mm
Tipo de cabezal	Flat Type <sup>1</sup>	Flat Type <sup>2</sup>	Flat Type <sup>2</sup>	Flat Type <sup>2</sup>	Flat Type <sup>1</sup>
<b>Etiquetas</b>					
Etiquetas en rollo o en zig-zag	Papel, cartón, textil, materiales sintéticos				
Máx. espesor del material	220 gr/m <sup>2</sup> (mayor bajo pedido)				
Ancho mín. de etiqueta	12 mm				
Altura mín. de etiqueta					
Estándar	5 mm				
Modo cortador/dispensador	15 mm				
Largo máx. de etiqueta	6000 mm	6000 mm	3000 mm	1000 mm	3000 mm
Diámetro máx. de rollo					
Rebobinador interno	180 mm				
Bobinador interno	---				
Diám. interior del rollo de eti.	40 mm / 75 mm (opción)				
Rebobinado de las etiquetas	exterior o interior				
Sensor de etiquetas	Transmisión y reflexión inferior				
<b>Ribbon</b>					
Sentido de rebobinado	exterior o interior				
Diámetro máx. de rollo	Ø 80 mm				
Diámetro interior	25,4 mm / 1"				
Largo máximo	450 m				
Ancho máx.	110 mm				
<b>Dimensiones (mm)</b>					
Ancho x alto x largo	236 x 238 x 374				
Peso	11 kg				
<b>Electrónica</b>					
Procesador	32 Bit Alta velocidad				
RAM	16 MB				
Ranura de expansión	Para tarjeta Compact Flash Tipo I				
Caché con batería	Para reloj en tiempo real y guardar datos al apagado				
Señal de aviso	Señal acústica cuando hay un error				
<b>Puertos</b>					
Serie	RS-232C (hasta 115200 baudios)				
Paralelo	SPP				
USB	2.0 High Speed Slave				
Ethernet	10/100 Base T, LPD, RawIP-Printing, DHCP, HTTP, FTP				
WLAN (opción)	Módulo 802.11 b/g/n WEP, WPA, WPA-PSK, WPA2, WPA2-PSK, EAP				

<sup>1</sup> = Térmica directa<sup>2</sup> = Transferencia térmica



Condiciones operativas	Vita II 103/8 T	Vita II 104/8	Vita II 106/12	Vita II 106/24	Vita II 108/12 T
Tensión nominal	110 ... 230 V AC / 50-60 Hz				
Consumo máx.	275 VA				
Corriente nominal	2,5 A				
Temperatura de funcionamiento	5 ... 35 °C				
Humedad máx. atmosférica	80 % (sin condensación)				
<b>Panel de control</b>					
Teclas	Prueba de impresión, Menú de funciones, Cantidad, Tarjeta CF, Avance de etiqueta, Intro, Cursor x 4				
LCD display	Display gráfico de 132 x 64 píxeles				
<b>Características</b>					
	Fecha, hora, turnos 20 idiomas (otro bajo pedido) Parámetros de etiqueta, de impresora, puertos, contraseña, variables				
<b>Monitorización</b>					
La impresión se detiene si:	Final de ribbon / Fin de etiquetas / Cabezal abierto				
Informe de Estado	Amplio informe del estado de la impresora con información sobre los parámetros. P.ej. largo de impresión, tiempo de impresión, puertos de las fotocélulas y parámetros de red. Impresión de todas las fuentes internas y códigos de barras en memoria.				
<b>Escritura</b>					
Tipos de letra	6 Fuentes Bitmap 8 Fuentes Vectoriales/TrueType 6 Fuentes proporcionales Otras fuentes bajo pedido				
Juego de caracteres	Windows 1250 a 1257, DOS 437, 850, 852, 857, UTF-8 Caracteres europeos occidentales y orientales, Latinos, Cirílicos, Griegos y Árabes (opción) Otros caracteres bajo pedido				
Tipos de letra bitmap	Tamaño variable en altura y anchura desde 0,8 ... 5,6 Zoom 2 ... 9 Orientación 0°, 90°, 180°, 270°				
Tipos de letra vectoriales/TrueType	Tamaño variable en altura y anchura desde 1 ... 99 mm Zoom Variable Orientación 0°, 90°, 180°, 270°				
Atributos de las fuentes	Depende de la fuente del carácter Negrita, Cursiva, Inversa, Vertical				
Distancia entre letras	Variable				
<b>Códigos de barra</b>					
Códigos de barra 1D	CODABAR, Code 128, Code 2/5 interleaved, Code 39, Code 39 extended, Code 93, EAN 13, EAN 8, EAN ADD ON, GS1-128, Identcode, ITF 14, Leitcode, Pharmacode, PZN 7 Code, PZN 8 Code, UPC-A, UPC-E				
Códigos de barra 2D	Aztec Code, CODABLOCK F, DataMatrix, GS1 DataMatrix, MAXICODE, PDF 417, QR Code				
Códigos compuestos	GS1 DataBar Expanded, GS1 DataBar Limited, GS1 DataBar Omnidireccional, GS1 DataBar Stacked, GS1 DataBar Stacked Omnidireccional, GS1 DataBar Truncated				
	Todos los códigos de barras son variables en altura, anchura y aspecto Orientación 0°, 90°, 180°, 270° Opcionalmente llevan dígito de control y línea de lectura				
<b>Software</b>					
Configuración	ConfigTool				
Control de procesos	NiceLabel				
Software de etiquetas	Labelstar Office Lite Labelstar Office				
Controladores de Windows	Windows 7® - Windows 10® 32/64 Bit Windows Server 2008® (R2) - Windows Server 2019®				

## Limpeza

Para los ajustes y montajes sencillos emplear la llave hexagonal suministrada que se encuentra en la parte inferior de la unidad



### ¡PELIGRO!

¡Existe riesgo de muerte por descarga eléctrica!

⇒ Antes de todos los trabajos de mantenimiento de la impresora desconecte la corriente de red y aguarde brevemente hasta que la fuente de red se haya descargado.



### ¡AVISO!

Para limpiar el aparato se recomienda llevar equipo de protección personal, como gafas de protección y guantes.

Tarea de mantenimiento	Intervalo
Limpeza general	Según sea necesario.
Limpeza del rodillo de tracción.	Con cada cambio de la cinta de transferencia o si se deteriora la imagen impresa.
Limpeza del rodillo de presión	Con cada cambio del rollo de etiquetas o si se deteriora la imagen impresa o el cargador de etiquetas.
Limpeza del cabezal de impresión	<b>Termoimpresión directa:</b> Con cada cambio del rollo de etiquetas. <b>Impresión de transferencia térmica:</b> Con cada cambio de la cinta de transferencia o si se deteriora la imagen impresa.
Limpeza de la fotocélula	Al cambiar el rollo de etiquetas.



### ¡AVISO!

Deben seguirse las instrucciones de manipulación para la utilización de alcohol isopropílico (IPA). En caso de contacto con la piel o los ojos, enjuagar bien con agua corriente. Si persiste la irritación, acuda a un médico. Asegúrese de que el lugar esté bien ventilado.



### ¡ADVERTENCIA!

¡Peligro de incendio debido a solvente para etiquetas inflamable!

⇒ Cuando se emplee solvente para etiquetas, la impresora de etiquetas debe encontrarse limpia y completamente libre de polvo.

## Limpeza general



### ¡PRECAUCIÓN!

¡La impresora se puede dañar si se utiliza productos de limpieza abrasivos!

⇒ No utilice detergentes abrasivos o disolventes para limpiar las superficies externas o las impresoras.

⇒ Extraiga el polvo y las partículas de papel que se encuentren en el área de impresión con un pincel suave.

⇒ Limpie las superficies externas con un producto de limpieza universal.

## Limpeza del rodillo de tracción de cinta de transferencia

El ensuciamiento del rodillo de presión puede repercutir en una mala calidad de impresión y además puede estropear el material de transporte.

- Levante la tapa de la impresora.
- Saque el ribbon de la impresora.
- Retire los depósitos con producto limpiador de rodillos y un paño suave.
- Si el rodillo parece dañado, sustitúyalo.

## Limpieza del rodillo de presión

El ensuciamiento del rodillo de presión puede repercutir en una mala calidad de impresión y además puede estropear el material de transporte.



### ¡PRECAUCIÓN!

¡Daño del rodillo de presión!

⇒ No utilice objetos afilados, puntiagudos o duros para limpiar el rodillo de presión.

- Gire la palanca en sentido contrario a las agujas del reloj para levantar el cabezal de impresión.
- Saque las etiquetas y la cinta de transferencia de la impresora.
- Retire los depósitos con producto limpiador de rodillos y un paño suave.
- Si el rodillo presenta daños, sustitúyalo.

## Limpieza del cabezal de impresión

Durante la impresión se puede ensuciar el cabezal de impresión p.ej. con partículas de color que se insertan en la cinta de transferencia; por ello es conveniente y básicamente necesario limpiar el cabezal a intervalos regulares de tiempo, dependiendo de las horas de funcionamiento del aparato y de la influencia del entorno, como por ejemplo, polvo u otros.



### ¡PRECAUCIÓN!

¡Daño del cabezal de impresión!

⇒ No utilice objetos afilados, puntiagudos o duros para limpiar el cabezal de impresión.

⇒ No toque la lámina protectora del cabezal de impresión.

- Gire la palanca en sentido contrario a las agujas del reloj para levantar el cabezal de impresión.
- Saque las etiquetas y la cinta de transferencia de la impresora.
- Limpie la superficie del cabezal de impresión con un bastón especial de limpieza o con un bastoncillo de algodón empapado en alcohol puro.
- Antes de poner en funcionamiento la impresora, dejar secar el cabezal de impresión durante 2 o 3 minutos.

## Limpieza la fotocélula



### ¡PRECAUCIÓN!

¡Deterioro de la fotocélula!

⇒ No utilice objetos afilados o duros ni disolventes para limpiar la fotocélula.

La fotocélula de etiquetas se puede ensuciar con el polvo del papel. Con ello puede resultar perjudicado el reconocimiento del inicio de las etiquetas.

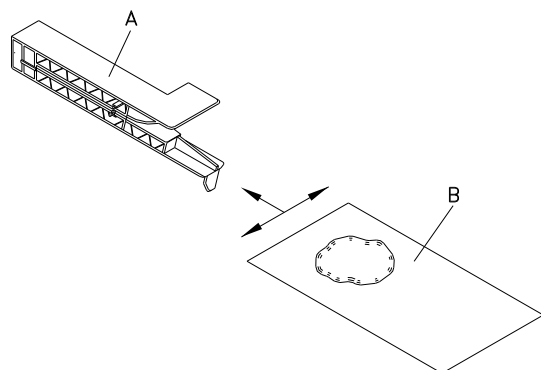

- Gire la palanca en sentido contrario a las agujas del reloj para levantar el cabezal de impresión.
- Saque las etiquetas y la cinta de transferencia de la impresora.
- Efectúe un soplado de la barrera óptica (A) con un pulverizador de gas comprimido. Es imprescindible seguir las instrucciones del envase.
- Adicionalmente, puede eliminar la suciedad en la barrera óptica con un cartón de limpieza (B) humedecido previamente con limpiador de cabezales y cilindros de impresión.
- Vuelva a colocar las etiquetas y la cinta de transferencia.



Guide de référence rapide et de  
sécurité des produits

Français

Copyright by Carl Valentin GmbH.

Les indications concernant le volume de livraison, l'apparence, la performance, les dimensions et le poids correspondent à nos connaissances au moment de la création de ce document.

Toutes modifications réservées.

Tous droits réservés, y compris ceux des traductions.

La reproduction, ou la transformation de ce manuel, partielle ou intégrale, sous quelque forme que ce soit (impression, photocopie ou tout autre procédé) est interdite sauf autorisation écrite de Carl Valentin GmbH.

Par l'évolution permanente, des différences peuvent survenir entre la documentation et le matériel.

Consulter le site internet [www.carl-valentin.de](http://www.carl-valentin.de) pour obtenir la dernière version.

### Marques

Toutes les marques ou tous les noms commerciaux sont des marques déposées ou des noms commerciaux déposés par leur propriétaire respectif, même s'ils ne sont pas expressément indiqués comme tels. En l'absence de cette mention, ils ne doivent toutefois pas être considérés comme une marque non déposée ou un nom commercial non déposé.

Les imprimantes d'étiquettes Carl Valentin répondent aux directives de sécurité suivantes:

- CE** Directives sur les appareils à basse tension (2014/35/UE)  
Directive relative à la compatibilité électromagnétique (2014/30/UE)



### Carl Valentin GmbH

Postfach 3744  
78026 Villingen-Schwenningen  
Neckarstraße 78 – 86 u. 94  
78056 Villingen-Schwenningen

Phone +49 7720 9712-0  
Fax +49 7720 9712-9901

E-Mail [info@carl-valentin.de](mailto:info@carl-valentin.de)  
Internet [www.carl-valentin.de](http://www.carl-valentin.de)

---

**Contenu**

Usage conforme	64
Consignes de sécurité	64
Dépollution conforme à l'environnement	64
Conditions d'opération	65
Déballer l'imprimante	68
Contenu de la livraison	68
Installer l'imprimante	68
Raccorder l'imprimante	68
Mettre en service l'imprimante	68
Insérer les étiquettes en mode bord denté	69
Insérer le film transfert	70
Print Settings (Initialisation d'imprimante)	71
Label Layout (Layout d'étiquette)	71
Device Settings (Paramètres d'appareil)	72
Network (Réseau)	74
Password (Mot de passe)	74
Interface (Interface)	75
Emulation (Emulation)	75
Date & Time (Date & Heure)	76
Service Functions (Fonctions service)	77
Main Menu (Menu principal)	79
Carte Compact Flash	80
Données techniques	84
Nettoyer le rouleau d'entraînement	86
Nettoyer le rouleau de pression	87
Nettoyer la tête d'impression	87
Nettoyer la cellule d'étiquettes	87

## Usage conforme

- L'imprimante répond à un niveau technique de pointe qui est conforme aux règles reconnues en matière de sécurité et des règlements. Malgré cela, un danger pour la vie et l'intégrité physique de l'utilisateur ou des tiers pourraient se poser et l'imprimante ou d'autres biens pourraient être endommagés pendant le fonctionnement du dispositif.
- L'imprimante doit être utilisée uniquement dans des conditions techniques conformes aux prescriptions, conscient de la sécurité et des dangers et en respectant le mode d'emploi. Certains dérangements, qui nuisent à la sécurité, doivent être éliminés immédiatement.
- L'imprimante est destinée exclusivement à imprimer des matériaux appropriés et autorisés par le fabricant. Une utilisation d'un autre type ou dépassant ce cadre n'est pas conforme aux prescriptions. Le fabricant/fournisseur ne répond pas des dommages résultant d'un usage inapproprié; seul l'utilisateur en porte le risque.
- Le respect du mode d'emploi fait partie également d'une utilisation conforme, y compris les recommandations / les prescriptions de maintenance données par le fabricant.

## Consignes de sécurité

- L'imprimante est conçue pour les réseaux électriques avec une tension alternative de 110 ... 230 V AC. Brancher l'imprimante uniquement à des prises électriques avec prise de terre.
- Raccorder l'imprimante uniquement avec des appareils qui induisent de la très basse tension de protection.
- Avant de faire ou de défaire les connexions, éteignez tous les appareils connectés (ordinateur, imprimante, accessoires, etc.).
- Utiliser l'imprimante uniquement dans un environnement sec et ne pas le mouiller (projection d'eau, brouillard, etc.).
- Les mesures d'entretien et de maintenance ne peuvent être effectuées que par un personnel spécialisé.
- Le personnel utilisant le système d'impression doit être instruit par l'exploitant conformément au mode d'emploi.
- Si l'imprimante est utilisée avec le capot ouvert, veiller à ce que les vêtements, les cheveux, les bijoux ou autres des utilisateurs n'entrent pas en contact avec les éléments en rotation.
- Le bloc d'impression et les composants (par exemple tête d'impression) peuvent devenir très chauds pendant l'impression. Ne pas toucher ces pièces pendant l'utilisation. Laisser refroidir les composants avant toutes interventions de maintenance ou de réglage.
- N'utiliser jamais des matières consommables facilement inflammables.
- Il existe un risque de blessure au niveau du bord denté. Si le bord denté n'est pas utilisé, fixez le profil de protection de bord.
- Exécuter uniquement les actions décrites dans ce mode d'emploi. Les travaux dépassant ce cadre doivent être effectués uniquement par le fabricant ou en accord avec le fabricant.
- Des interventions inadéquates sur les parties électroniques ou leurs logiciels peuvent causer des dysfonctionnements.
- D'autres interventions inappropriées ou transformations de l'appareil peuvent avoir une incidence sur sa sécurité.
- Les réparations doivent toujours être effectuées dans un atelier qualifié possédant les compétences et le matériel nécessaires pour une remise en état optimale.
- Des autocollants sont disposés sur le matériel afin de mettre en garde l'utilisateur sur les dangers auxquels il pourrait être exposé. Ne pas retirer ces autocollants afin d'être constamment informé de la présence de ces risques.



### **DANGER!**

Danger de mort par tension électrique!

⇒ Ne pas ouvrir le capot de protection.

## Dépollution conforme à l'environnement

Des fabricants des appareils B2B sont obligés à partir du 23 mars 2006 à reprendre et recycler des appareils anciens qui ont été fabriqués après le 13 août 2005. Ces appareils anciens ne peuvent pas principalement être transmis à des points de ramassage communaux. Ils ne peuvent être recyclés organisés et éliminés les déchets que par le fabricant. En conséquence des produits Valentin conformément marqués peuvent être retournés à l'avenir à Carl Valentin GmbH.

Les appareils anciens sont éliminés les déchets de façon appropriée.

Carl Valentin GmbH perçoit à temps toutes les obligations dans le cadre de l'enlèvement des déchets d'appareils anciens et permet ainsi aussi la vente des produits sans difficultés. Veuillez faire attention que nous ne pouvons reprendre des appareils envoyés que franco de port.

La plaque d'électronique du système d'impression est équipée avec une batterie. Dépolluer cette batterie dans des cuves de dépôt de batteries usagées provenant du commerce ou après des centres officiels homologués de dépollution.

Pour plusieurs informations, voyez la directive DEEE ou notre page web [www.carl-valentin.de](http://www.carl-valentin.de).



## Conditions d'opération

**Avant la mise en route et pendant l'utilisation** de nos imprimantes, observer les conditions d'utilisation pour assurer une fonction sans perturbation.

Lire soigneusement ces conditions d'utilisation.

En cas de questions au sujet de l'utilisation pratique de ces conditions veuillez contacter votre distributeur.

## Conditions générales

Transporter et stocker nos systèmes exclusivement dans leur emballage d'origine.

L'installation et la mise en service de l'imprimante n'est autorisée que si les conditions d'exploitation ont été remplies.

Avant la mise en service, la programmation, l'utilisation, le nettoyage et l'entretien de nos imprimantes, lire attentivement ces instructions.

Seuls les opérateurs expérimentés sont autorisés à manier nos imprimantes.



### REMARQUE!

Effectuer régulièrement des formations.

Le contenu des formations comprend les chapitres 'Conditions d'opération', 'Insérer le matériau' et 'Maintenance et nettoyage'.

Ces instructions sont également valables pour les appareils livrés et non produits par notre société.

N'utiliser que des pièces de recharge d'origine.

Pour les pièces détachées/d'usure, veuillez vous adresser au fabricant.

## Conditions pour le lieu d'installation

Le lieu d'installation doit être plat, exempt de vibrations et de courants d'air.

Installer les imprimantes de manière à pouvoir effectuer l'entretien sans trop de difficultés.

## Installation de l'alimentation

L'installation de l'alimentation de nos imprimantes directe doit être effectuée selon les règles internationales, surtout selon les recommandations d'une des trois commissions suivantes:

- International Electronic Commission (IEC)
- Comité Européen pour Normes Electroniques (CENELEC)
- Verband Deutscher Elektrotechniker (VDE)

Nos imprimantes sont construites selon les règles VDE et ne fonctionnent qu'avec prise de terre. L'alimentation doit être équipée d'une prise de terre pour éliminer le parasitage interne.

## Indications techniques de l'alimentation

Tension et fréquence d'alimentation	Voir plaque signalétique
Tolérance admissible de la tension d'alimentation:	+6 % ... -10 % de la valeur nominale
Tolérance admissible de la fréquence d'alimentation:	+2 % ... -2 % de la valeur nominale
Facteur distorsion admissible de la tension d'alimentation:	≤ 5 %

### Mesures antiparasites:

Dans le cas où votre réseau est infecté (p.ex. en utilisant des machines contrôles thyristor) il faut prendre des mesures antiparasites, par exemple:

- Prévoir une alimentation séparée pour nos imprimantes.
- En cas de problème, il faut installer un transformateur d'isolement ou un filtre antiparasite en amont de l'alimentation électrique de nos appareils.

## Perturbation atmosphérique et immunité

Émission de perturbation conformément à EN 61000-6-3: 2007 secteur d'industrie

- Tension de perturbation sur lignes conformément à EN 55022: 09-2003
- Puissance de perturbation conformément à EN 55022: 09-2003
- Courant harmonique (réseau rétroaction) conformément à EN 61000-3-2: 09-2006
- Flicker conformément à EN 61000-3-3: 1955 + A1:2001 + A2:2005

Immunité conformément à EN 61000-6-2: 2005 secteur d'industrie

- Immunité contre un déchargement d'électricité statique conformément à EN 61000-4-2: 12-2001
- Champs électromagnétiques conformément à EN 61000-4-3: 11-2003, ENV 50204: 03-1995
- Immunité contre perturbation (burst) rapide transitoire conformément à EN 61000-4-4: 07-2005
- Immunité contre tension transitoires (surge) conformément à EN 61000-4-5: 12-2001
- Tension HF conformément à EN 61000-4-6: 12-2001
- Interruptions de tension et abaissement de tension conformément à EN 61000-4-11: 02-2005



### REMARQUE!

Il s'agit d'une machine de la classe A. Cette machine peut causer interférences dans le secteur de logement; dans ce cas on peut exiger d'opérateur d'exécuter des mesures appropriées et d'assumer pour cela.

## Connexions aux machines externes

Toutes les connexions devront comporter des filtres antiparasites. La tresse de blindage doit être fixée, sur une grande surface, des deux côtés du boîtier de connexion.

Il est interdit de guider les câbles parallèles aux lignes de courant. Dans le cas où une connexion parallèle ne peut pas être évitée, il faut observer une distance d'au moins 0,5 m.

Température des lignes: -15 ... +80 °C.

Il est seulement permis de connecter des appareils qui répondent à la demande «de sécurité très basse tension» (SELV). Ce sont généralement des dispositifs qui sont vérifiées et correspondant à la norme EN 60950/EN 62368-1.

## Installation des lignes données

Les câbles de données doivent être protégés complètement et équipés avec des connecteurs enfichables métalliques ou métallisés. Des câbles blindés et des connecteurs enfichables sont nécessaires pour éviter l'émission et la réception de perturbations électriques.

Lignes admissibles

Lignes sans parasite:            4 x 2 x 0,14 mm<sup>2</sup> ( 4 x 2 x AWG 26)  
    6 x 2 x 0,14 mm<sup>2</sup> ( 6 x 2 x AWG 26)  
    12 x 2 x 0,14 mm<sup>2</sup> (12 x 2 x AWG 26)

Emetteurs et récepteurs doivent être tressés par paires.

Longueur max. des lignes        Interface V 24 (RS232C) - 3 m (avec isolement)  
    Interface parallèle - 3 m (avec isolement)  
    USB - 3 m  
    Ethernet - 100 m

## Circulation d'air

Pour éviter une accumulation de chaleur, la circulation d'air autour de l'appareil doit être garantie.

## Valeurs limites

Protection selon IP:	20
Température ambiante °C (opération):	Min. +5 Max. +35
Température ambiante °C (stockage):	Min. -20 Max. +60
Humidité atmosphérique % (opération):	Max. 80
Humidité atmosphérique % (stockage):	Max. 80 (éviter que les appareils se couvrent de rosée)

## Garantie

Nous ne sommes pas responsables de dommages occasionnés par:

- Inobservation de nos conditions d'opération et du manuel d'opération.
- Installation électrique incorrecte des environs.
- Modifications constructives de nos appareils.
- Programmation et opération incorrectes.
- Protection de données non exécutée
- Utilisation de pièces de rechange et d'accessoires pas originales.
- Usure naturelle et dégradation.

Si nos imprimantes sont installées et programmées, contrôler les nouveaux paramètres par une fonction test et une impression test. De cette façon, des résultats mauvais sont évités.

Seuls les opérateurs expérimentés sont autorisés à l'opération de nos imprimantes.

Contrôler le traitement correct de nos produits et répétez les cours d'instruction.

Nous ne prenons pas de garantie que les caractères décrits dans ce manuel existent dans tous les modèles. Due à nos efforts de développement et d'amélioration continués les dates techniques indiquées sont sous réserves de modification.

Causé par la mise au point continuée ou par les règlements des pays les illustrations et les exemples montrés dans ce manuel peuvent différer du type livré.

Pour éviter des dommages ou usure prématurée veuillez faire attention aux informations sur les matériaux autorisés et les indications sur le nettoyage.

Nous avons fait notre mieux d'écrire le manuel compréhensible pour soumettre le plus informations que possible. En cas de questions ou erreurs, envoyer les par email afin que nous puissions les corriger.

## Déballer l'imprimante

- ⇒ Soulevez l'imprimante par le fond de l'appareil et sortez-la du carton.
- ⇒ Vérifier l'état de l'imprimante suite au transport.
- ⇒ Contrôler entièrement la livraison.

## Étendue de la livraison

- Imprimante d'étiquettes.
- Mandrin de film transfert vide, monté sur l'enrouleur de film transfert.
- Bord denté (uniquement sur les appareils de base).
- Bord de distributeur (uniquement sur les appareils avec l'option distributeur d'étiquettes).
- Câble secteur.
- Documentation.
- CD avec des pilotes d'imprimante.
- Labelstar Office LITE.



### REMARQUE!

Conserver l'emballage d'origine dans le cas d'un retour (maintenance).

## Installer l'imprimante



### ATTENTION!

L'imprimante peut être endommagée par l'humidité et l'eau.

- ⇒ Mettre en place l'imprimante uniquement dans un endroit sec protégé contre les projections d'eau.
- ⇒ Mettre l'imprimante sur un endroit plat, exempt de vibrations et de courant d'air.
- ⇒ Ouvrir le capot de l'imprimante.
- ⇒ Enlever la mousse des protections de transport au niveau de la tête d'impression.

## Raccorder l'imprimante

L'imprimante est équipée d'une alimentation en énergie à grand champ. Le fonctionnement avec une tension de réseau de 110 ... 230 V AC / 50-60 Hz est possible sans intervention sur l'appareil.



### ATTENTION!

L'imprimante peut être endommagée par des hausses d'intensité de courant au démarrage.

- ⇒ Avant la connexion au réseau, placer l'interrupteur sur la position '0'.
- ⇒ Mettre le câble dans la prise de connexion réseau.
- ⇒ Enfiler la fiche du câble réseau dans la prise reliée à la terre.



### REMARQUE!

En cas de mise à la terre insuffisante ou défailante, des perturbations de fonctionnement peuvent survenir.

Veiller à ce que tous les ordinateurs connectés à l'imprimante ainsi que les câbles de raccordement soient reliés à la terre.

- ⇒ Raccorder l'imprimante à l'ordinateur ou au réseau avec un câble approprié.

## Mettre en service l'imprimante

Quand toutes les connexions sont réalisées

- ⇒ Mettre en marche l'imprimante à l'aide de l'interrupteur.  
Après avoir mis en marche l'imprimante, le menu principal apparaît, celui-ci indique le type d'imprimante, la date et l'heure actuelle.
- ⇒ Insérer le rouleau d'étiquettes et le film transfert
- ⇒ Démarrer la mesure dans le menu *Layout d'étiquette/Mesurer étiquette*.
- ⇒ Appuyer sur la touche  pour terminer la mesure.



### REMARQUE!

Pour permettre une mesure correcte, au moins deux étiquettes entières doivent être sorties (pas pour des étiquettes continues).

Des faibles différences peuvent apparaître lors de la mesure de la longueur d'étiquette et de l'espace. Pour cette raison, les valeurs peuvent être ajustées manuellement dans le menu *Layout d'étiquette/Étiquette et Espace*.

## Insérer les étiquettes en mode bord denté

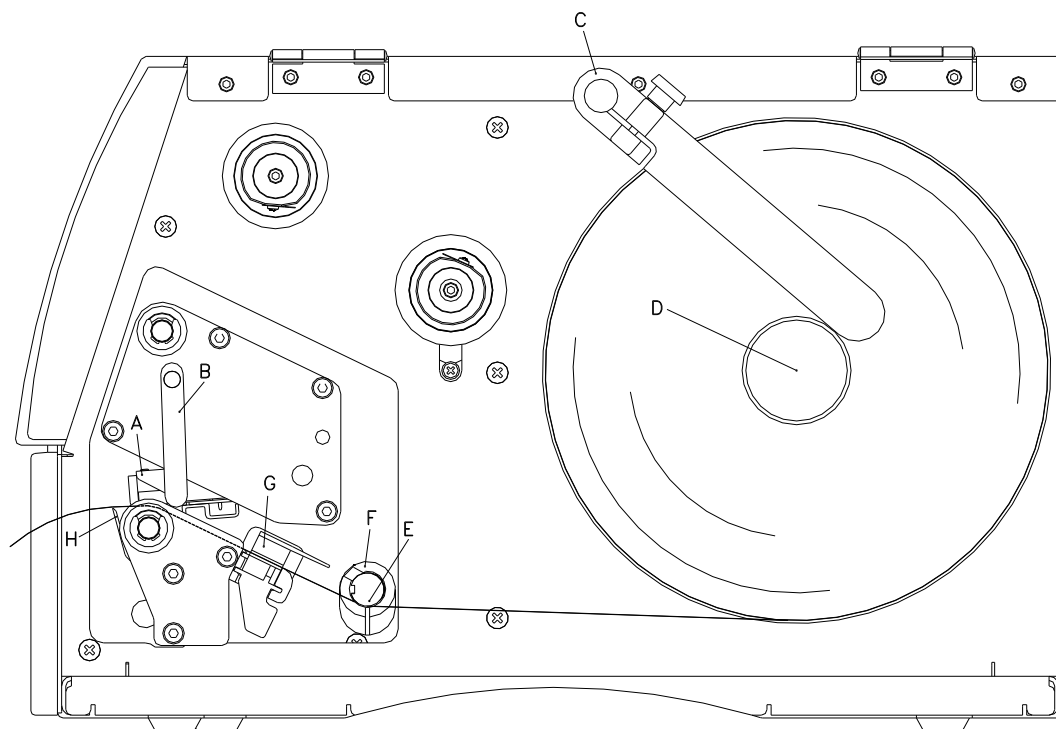

- Ouvrir le couvercle de l'imprimante.
- Pour déverrouiller la tête d'impression (G), tourner le levier rouge (F) dans le sens inverse des aiguilles d'une montre.
- Enlever la flasque extérieure (A).
- Positionner le rouleau d'étiquettes avec un déroulement vers l'intérieur sur le dispositif de déroulement (B).
- Remettre e place la flasque extérieure (A).
- Faire passer les étiquettes au-dessous de l'axe de renvoi (C) et de la tête d'impression (G).  
Faire attention à ce que la bande passe dans la cellule (E).
- Pour fermer la tête d'impression (G), tourner le levier rouge (F) dans le sens des aiguilles d'une montre jusqu'à ce qu'il engage.
- Avant de la tête d'impression se trouve le bord denté (H).
- Entrer la valeur offset au point menu *Initialisation/Bord denté*.
- Ajuster la bague de réglage (D) au niveau de l'axe de renvoi (C) sur la largeur de l'étiquette.
- Fermer le couvercle de l'imprimante.

## Insérer le film transfert



### REMARQUE!

Pour imprimer en mode transfert thermique on doit mettre en place un film transfert. Pour utiliser l'imprimante en mode thermique directe on ne doit pas mettre de film transfert dans l'imprimante. N'utiliser pas un film transfert plus étroit que le support d'impression. Si le film transfert est plus étroit que le support d'impression la tête reste en partie non protégée et risque de s'user prématurément.

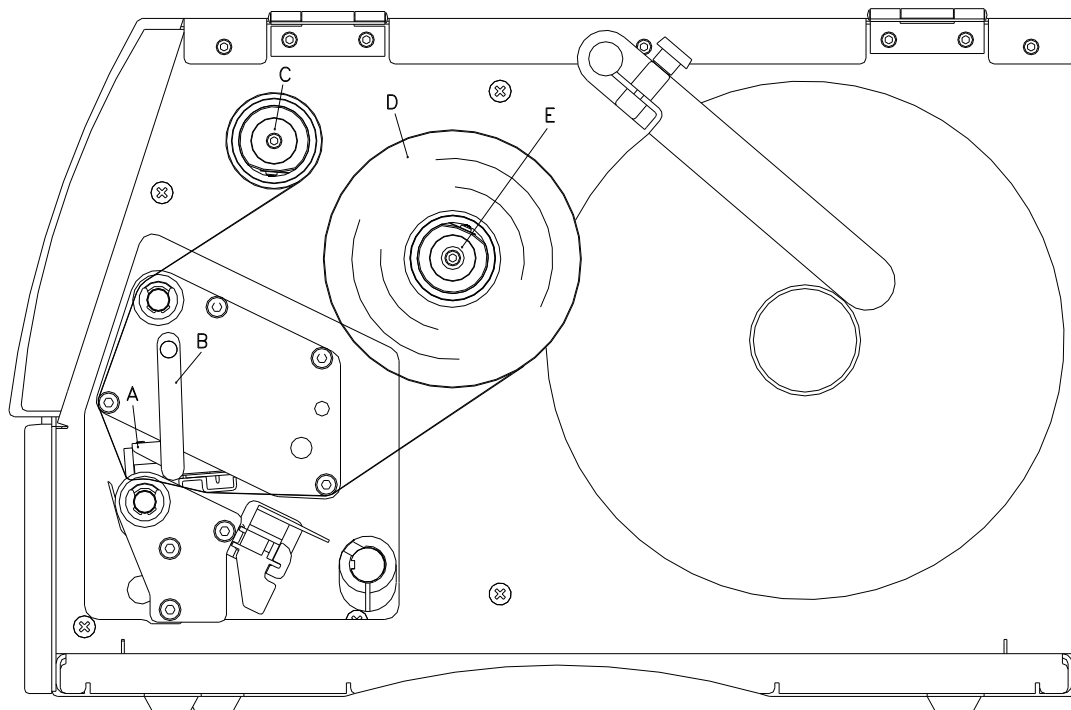

### REMARQUE!

Avant de mettre en place un nouveau rouleau film transfert nous recommandons de nettoyer la tête d'impression avec le détergent pour la tête et le rouleau (97.20.002). Veuillez observer les recommandations de manipulation pour l'utilisation d'isopropanol (IPA). En cas de contact avec les yeux ou la peau, rincer abondamment à l'eau courante. En cas d'irritation persistante, consulter un médecin. Assurer une ventilation suffisante.

- Nettoyer la tête d'impression avant la mise en place du film transfert.
- Ouvrir le couvercle de l'imprimante.
- Pour déverrouiller la tête d'impression (E), tourner le levier rouge (D) dans le sens inverse des aiguilles d'une montre.



### ATTENTION!

Risque d'écorchures en insérant du film transfert et/ou en retirant le film transfert usagé!  
 ⇒ Faire attention aux bords de la tôle élastique à ressorts!

- Placer le rouleau du film transfert (B) avec un déroulement vers l'extérieur sur le dispositif de déroulement (C).
- Pousser un mandrin vide du film transfert sur le rouleau d'enroulement (A) et guider le film transfert au-dessous de la tête d'impression (E).
- Fixer le début du film transfert avec un ruban adhésif en direction à imprimer sur mandrin vide (A). Faire attention au sens d'enroulement du film transfert qui est dans le sens inverse des aiguilles d'une montre.
- Pour fermer la tête d'impression (E), tourner le levier rouge (D) dans le sens des aiguilles d'une montre jusqu'à ce qu'il engage.
- Fermer le couvercle de l'imprimante.



### REMARQUE!

Comme une décharge électrostatique peut abîmer la couche fine de la tête d'impression et d'autres pièces électroniques, il est conseillé d'utiliser uniquement que des films transferts antistatique. L'utilisation de matériaux inadéquats peut entraîner des dysfonctionnements et la garantie peut expirer.



### ATTENTION!

Influence du matériel statique sur l'homme!

⇒ Utiliser le film de transfert antistatique car une décharge d'électricité statique risquerait sinon de se produire lors du prélèvement.

## Print Settings (Initialisation d'impression)

Touches:  

### Speed (Vitesse)

Indication de la vitesse d'impression en mm/s.  
Valeurs possibles: 50 mm/s ... 200 mm/s (voir les données techniques).

### Contrast (Contraste)

Indication de l'intensité d'impression lors de l'utilisation des différents matériaux, vitesses d'impression ou les contenus d'impression.  
Valeurs possibles: 10 % ... 200 %.

Touche: 

### Transfer ribbon control (Contrôle film transfert)

Il permet de contrôler si le rouleau film transfert est fini ou si le film transfert est cassé.  
**Off:** Le contrôle film transfert est désactivé, c'est-à-dire l'imprimante continue d'imprimer sans message d'erreur.  
**On, weak sensibility (sensibilité faible):** L'ordre d'impression courant est interrompu et un message d'erreur s'affiche à l'écran. L'imprimante réagit environ 1/3 plus lentement sur la fin du film transfert (default).  
**On, strong sensibility (sensibilité forte):** L'ordre d'impression courant est interrompu et un message d'erreur s'affiche à l'écran. L'imprimante réagit immédiatement sur la fin du film transfert.

Touche: 

### Y déplacement (Déplacement Y)

Déplacement de l'étiquette en direction verticale.  
Valeurs possibles: -30.0 ... +90.0.

Touche: 

### X déplacement (Déplacement X)

Déplacement des champs sur l'étiquette en position horizontale.  
Valeurs possibles: -90.0 ... +90.0.

Touche: 

### Tear-off Offset (Bord denté)

Indication de la valeur par laquelle la dernière étiquette d'un ordre d'impression est sortie en avant, au prochain départ d'impression l'étiquette reculera au début de l'étiquette.  
Valeurs possibles: 0 ... 70.0 mm  
Valeur standard: 13 mm.

## Label Layout (Layout d'étiquette)

Touches:   

### Label length (Longueur étiquette)

Indication de la longueur d'étiquette en mm.  
Hauteur minimum: 5 mm (distributeur d'étiquettes 25 mm).

### Gap length (Longueur espace)

Indication de la distance entre deux étiquettes en mm.  
Valeur minimale: 1 mm.

Touche: 

### Column printing (Impression en plusieurs colonnes)

Indication de la largeur d'étiquette ainsi que de l'indication du nombre d'étiquettes se trouvant cote à cote sur la bande.

Touche: 

### Measure label (Mésurer étiquette)

Appuyer sur la touche  pour démarrer la mesure.

Touche: 

### Label type (Type d'étiquette)

En standard, les étiquettes adhésives sont réglées. Appuyer sur la touche  pour sélectionner des étiquettes en continu.

Touche: 

### Material selection (Sélection de matériel)

Sélection du matériau de l'étiquette et du film transfert.

Touche: 

### Photocell (Cellule)

Sélection de la cellule utilisée.  
Les possibilités suivantes sont disponibles: Cellule transmission normale et inverse, cellule réflexion normale et inverse, cellule ultrasonique (option).

### Scan position (Scan position)

Entrée de la longueur de l'étiquette en pourcentage à partir de cette valeur la fin de l'étiquette est cherchée. De ce fait, les marquages sur l'étiquette peuvent être sautés.

Touche: **Label error length  
(Étiquette longueur  
d'erreur)**

Indication après combien de mm, dans le cas d'une erreur, un message doit apparaître à l'écran.  
Valeurs possibles: 1 mm ... 999 mm.

**Synchronization  
(Synchronisation)**

**On:** Si une étiquette manque sur le papier de support un message d'erreur est affiché.  
**Off:** Étiquettes manquantes sont ignorées, c'est-à-dire qu'il y a une impression sur le support.

Touche: **Flip label  
(Retourner étiquette)**

L'étiquette s'imprime en mode miroir. Si la largeur de l'étiquette n'a pas été transférée à l'imprimante, la largeur de défaut est utilisée, c'est-à-dire la largeur de la tête d'impression. Faire attention à ce que l'étiquette soit aussi large que la tête d'impression. Autrement cela pourrait causer des problèmes lors de la mise en page.

Touche: **Rotate label  
(Faire pivoter)**

Par défaut l'étiquette est imprimée en avant avec une rotation de 0°. Si la fonction est activée, l'étiquette est tournée de 180° et s'imprime dans le sens de la lecture.

Touche: **Rotate label in degrees  
Faire pivoter étiquette en  
degrés**

Conformément au paramètre *Faire pivoter étiquette*, l'étiquette peut être tournée par étapes de 90°.

**REMARQUE!**

Seulement des objets (textes, lignes et codes barres) peuvent être tournés. La rotation des graphiques n'est pas possible.

Touche: **Alignement  
(Alignement)**

L'alignement de l'étiquette est effectuée après 'retourner/faire pivoter étiquette', c.-à-d. l'alignement est indépendant des fonctions retourner et faire pivoter.

**Left (A gauche):** L'étiquette est alignée au bord gauche de la tête d'impression.

**Centre (Centré):** L'étiquette est alignée au point central de la tête d'impression.

**Right (A droite):** L'étiquette est alignée au bord droit de la tête d'impression.

**Device Settings (Paramètres d'appareil)**Touches:    **Field handling  
(Contrôle de champ)**

**Off:** La mémoire de module d'impression est complètement supprimée.

**Keep graphic (graphique reçu):** Un graphique ou bien une police TrueType sont transmis une fois au module d'impression et sont mémorisés dans la mémoire interne. Lors des prochains ordres d'impression, il n'y a que les données modifiées qui sont transmises au module d'impression. Ici l'avantage est d'économiser le temps pour transmettre les données graphiques.

Les données graphiques créés par le module d'impression (les polices internes, les codes à barres, ...) sont générées uniquement si elles ont été modifiées.

**Delete graphic (graphique effacer):** Les graphiques ou bien les polices TrueType mémorisés dans la mémoire interne sont effacés mais pas les autres champs.

**Restore graphic (Restaurer graphique):** Après la fin d'un ordre d'impression, à l'imprimante l'ordre d'impression peut être commencé de nouveau. Toutes les graphiques et les polices TrueType sont imprimées à nouveau.

**REMARQUE!**

**Exception:** Avec l'impression de plusieurs colonnes, des colonnes pleines doivent toujours être imprimées (nombre de pièces toujours multiple des colonnes). Des colonnes effacées ne seront pas restaurées.

Touche: **Codepage  
(Page de code)**

Indication de la page de caractère utilisée par l'imprimante. Les possibilités suivantes sont disponibles: Page de code 437, Page de code 850, Page de code 852, Page de code 857, Page de code 1250, Page de code 1251, Page de code 1252, Page de code 1253, Page de code 1254, Page de code 1257, WGL4.

Nous offrons le tableau sur des page de codes ci-dessus à notre Site Internet.

Touche: **External parameters  
(Paramètres externes)**

**Label dimension only (Seulement dimension étiquette):** Les paramètres pour la longueur des étiquettes, l'espace entre deux étiquettes et la largeur des étiquettes peuvent être transmis. Tous les autres paramètres doivent être faits directement à l'imprimante.

**On:** Il est possible de transmettre les paramètres comme par exemple la vitesse d'impression et le contraste via notre logiciel de création d'étiquettes à l'imprimante. Les paramètres qui sont réglés auparavant directement sur l'imprimante ne sont plus pris en considération.

**Off:** Seul les réglages effectués directement sur l'imprimante sont pris en considération.



Touche: **Buzzer  
(Buzzer)**

**On:** En appuyant sur une touche on peut entendre un signal acoustique.  
Valeurs possibles: 1 ... 7.

**Off:** On ne peut entendre le signal acoustique.

**Display  
(Display)**

Paramètres du contraste de l'écran.  
Valeurs possibles: 45 ... 75.

Touche: **Language  
(Langue)**

Sélection de la langue dans laquelle les textes à l'écran sont indiqués. Actuellement les langues suivantes sont disponibles: allemande, anglaise, française, espagnole, finlandaise, tchèque, portugaise, néerlandaise, italienne, danoise, polonaise, grec, hongrois, russe, chinois (option), ukrainien, turc, suédois, norvégien, estonien.

Touche: **Keyboard  
(Clavier)**

Sélection du mode que vous voulez utiliser sur votre clavier. A ce moment les modes suivantes sont disponibles: Allemagne, Angleterre, France, Grèce, Espagne, Suède, US et Russie.

Touche: **Customized entry  
(Entrée personnalisée)**

**Off:** Il n'y a pas de question pour la variable personnalisée. Dans ce cas une valeur par défaut est imprimée.

**On:** La question de la variable personnalisée s'affiche uniquement avant l'impression à l'écran.

**(Auto) Automatique:** La question de la variable personnalisée et la quantité s'affiche après chaque layout.

**Auto without quantity query (Automatique sans interrogation de la quantité):** La question de la variable personnalisée s'affiche après chaque layout sans une interrogation supplémentaire de la quantité.

Touche: **Hotstart  
(Hotstart)**

**On:** C'est possible de continuer un ordre d'impression interrompu après avoir allumé de nouveau l'imprimante.

**Off:** Après avoir éteint l'imprimante toutes les données se perdent.

Touche: **Autoload  
(Autoload)**



**On:** Une étiquette qui a été chargée une fois de la carte Compact Flash peut être chargée à nouveau automatiquement après un redémarrage de l'imprimante.

L'étiquette qui a été utilisée pour la dernière fois de la carte CF est toujours chargée automatiquement après un redémarrage de l'imprimante.

**Off:** Après un redémarrage de l'imprimante, l'étiquette utilisée pour la dernière fois doit être chargée de nouveau manuellement de la CF.

Une utilisation commune des fonctions Autoload et Hotstart n'est pas possible.

Touche: **Manual reprint  
(Réimpression manuelle)**

**Oui:** Si l'imprimante se trouve en mode arrêt (par ex. à cause d'une erreur), on peut réimprimer la dernière étiquette avec les touches  et .

**Non:** Seulement des étiquettes blanches sont avancées.

Touche: **Backfeed/Delay  
(Retour / retard)**

**Backfeed (Retour):** Le retour dans les modes de distributeur (option) et massicot (option) ont été optimisés. Maintenant, lors de l'offset d'avance, la prochaine étiquette est pré-imprimée si possible. De ce fait le retour étiquette n'est pas nécessaire et on gagne du temps.

**Delay (Retard):** Le temps de retard réglable est important uniquement pour le mode *Retour automatique*.

Touche: **Confirm label change  
(Confirmation étiquette)**

**On:** Un nouvel ordre d'impression est imprimé après la confirmation à la machine.

Un ordre d'impression continu actif est imprimé tant que la confirmation n'a pas été effectuée à la machine.

**Off:** Il n'y a pas d'interrogation au display de l'imprimante.

Touche: **Standard label  
(Étiquette standard)**

**On:** Si un ordre d'impression débute sans définition d'une étiquette précédente, l'étiquette standard (type d'appareil, version de firmware, version build) est imprimée.

**Off:** Si un ordre d'impression débute sans définition d'une étiquette précédente, un message d'erreur apparaît.

Touche: **Synchronization at switching on (Synchronisation à la mise en marche)****On:** La synchronisation est désactivée, c.-à-d. le mesurage et l'avance d'étiquette doivent être démarrés manuellement.**Measure (Mesurer):** Pour démarrer la mesure on doit accéder au menu correspondant.**Label feed (Avance d'étiquette):** Après la mise en marche de l'imprimante, l'étiquette est synchronisée au début de l'étiquette. Pour cela une ou plusieurs étiquettes sont avancées.Touche: **CMI length (Longueur CMI)**

Si l'impression dans l'étiquette est interrompue, il peut y avoir à la tête d'impression d'une interruption dans l'image d'impression une ligne blanche fine est visible). Pour éviter, une valeur pour le retour minimal peut être réglée (0 – 1 mm), par laquelle la bande d'étiquette est rétirée. À la prochaine démarrage d'impression, le secteur libre est surimprimé. Le réglage de la valeur CMI est important uniquement pour le mode Retour optimisé.

**Network (Réseau)**Touches:     

Pour des informations plus détaillées concernant cette option, voir le manuel réseau.

**Password (Mot de passe)**Touches:      **Operation (Opération)****Password (Mot de passe)** Entrée d'un mot de passe numérique à quatre chiffres.Touche: **Protection configuration (Protection menu Fonction)**

Les paramètres d'impression peuvent être modifiés dans le menu de fonction (contraste, vitesse, mode, ...). La protection par mot de passe empêche d'effectuer les modifications des paramètres d'impression.

Touche: **Protection favorites (Protection liste des favoris)**

La protection par mot de passe évite l'accès sur le menu de la liste des favoris.

Touche: **Protection memory card (Protection carte mémoire)**

Avec les fonctions de la carte mémoire on peut mémoriser, charger, ... des étiquettes. Ici la protection par mot de passe doit différencier si aucune fonction ou seulement la fonction lire est autorisée.

**Accès complet:** Pas de protection de passe**Lecture seule:** Accès seulement lisant possible**Protégé:** Accès bloquéTouche: **Protection printing (Protection impression)**

Si l'imprimante est connectée à un PC il pourrait être avantageux que l'opérateur ne puisse pas démarrer l'impression manuellement. Donc la protection par mot de passe empêche une impression manuelle.

**Network (Réseau)****Password (Mot de passe)** Entrée d'un mot de passe à 15 chiffres. L'entrée peut se composer d'alphabétiques et des caractères spéciaux.Touche: **Protection HTTP (Protection HTTP)**

La communication sur HTTP peut être évitée.

Touche: **Protection Telnet (Protection Telnet)**

Les réglages du service Telnet ne peuvent pas être modifiés.

Touche: **Protection remote access  
(Protection l'accès à distance)**

L'accès sur un port HMI externe peut être empêché.

**REMARQUE!**

Pour activer une fonction bloquée, il doit d'abord entrer le mot de passe correct. Si la correct mot de passe a été, la fonction désirée peut être démarrée.

**Interface (Interface)**Touches:        **COM1 / Baud / P / D / S****COM1:**

0 - Port série Off

1 - Port série On

2 - Port série On; mais en cas d'une erreur de transmission il n'y a pas de message d'erreur.

**Baud rate (Baud):**

Indication du nombre de Bits transmis par seconde.

Valeurs possibles: 1200, 2400, 4800, 9600, 19200, 38400, 57600 et 115200.

**P = Parity (Parité):**

N - Non parité; E - Pair (even); O - Impair (odd)

Faire attention à ce que les réglages soient identique entre l'imprimante et l'ordinateur.

**D = Data bits (Bits de données):**







Réglage des bits de données. Valeurs possibles: 7 ou 8 bits.

**S = Stop bit (Bits d'arrêt):**

Indication des bits d'arrêt entre les bytes. Valeurs possibles: 1 ou 2 bits d'arrêt.

Touche: **Start/stop sign  
(Signe de départ/fin)****SOH:** Début de trame → Hex-Format 01**ETB:** Fin de trame → Hex-Format 17Touche: **Data memory  
(Mémoire données)****Standard (Défaut):** Après avoir démarré un ordre d'impression, l'imprimante peut recevoir des données jusqu'à ce que le buffer d'impression soit plein.**Advanced (Elargit):** Pendant un ordre d'impression, les données sont reçues et traitées en même temps.**Off:** Tant qu'un ordre d'impression est en cours, l'imprimante ne peut pas recevoir de données.Touche: **Port test  
(Contrôle interface)**

Vérification si des données sont transférées sur l'interface.

Appuyer sur les touches  et  pour sélectionner 'Général' (On). Appuyer sur la touche  et les données qui sont envoyées sur un port arbitraire (COM1, LPT, USB, TCP/IP) sont imprimées.**Emulation (Emulation)**Touches:        **Protocole  
(Protocole)****CVPL:** Carl Valentin Programming Language**ZPL:** Zebra® Programming LanguageAppuyer sur les touches  et  pour sélectionner le protocole. Appuyer sur la touche  pour confirmer la sélection. L'imprimante exécute un redémarrage et après l'imprimante convertis en interne les commandes ZPL II® en commandes CVPL et celles-ci seront exécutées par l'imprimante.Touche: **Printhead resolution  
(Résolution de la tête d'impression)**

Avec l'émulation ZPL II® active, la résolution de la tête d'impression du module d'impression directe émulé doit être réglée.

**REMARQUE!**

Si la résolution de l'imprimante Zebra II® et l'appareil Valentin est différente, la taille des objets (par ex. textes, graphiques) ne correspondra pas précisément.

Touche: **Drive mapping  
(Allocation lecteur)**

L'accès aux lecteurs Zebra® a été dérivé sur les lecteurs Valentin correspondants.

**REMARQUE!**





Puisque les fonts internes dans les imprimantes Zebra® n'existent pas dans les appareils Valentin, cela peut causer de faibles différences dans l'image du texte.

Touche: **PJL – Printer Job  
Language  
(PJL – Printer Job  
Language)**

Informations de status concernant de l'ordre d'impression peuvent être indiquées.

**Date & Time (Date & Heure)**Touches:          **Set date/time  
(Modification de la  
date et de l'heure)**

La première ligne de l'écran indique la date actuelle et la deuxième ligne l'heure actuelle.

Appuyer sur les touches  et  pour arriver au prochain champ. Utiliser les touches  et  pour augmenter et/ou diminuer les valeurs indiquées.Touche: **Summertime  
(Heure d'été)****On:** L'imprimante passe automatiquement l'heure d'été ou bien d'hiver.**Off:** L'heure d'été n'est pas automatiquement détectée et convertie.Touche: **Start of summertime -  
format  
(Début de l'heure d'été –  
format)**

Sélection de format d'entrer du passage à l'heure d'été.

DD = jour

WW = semaine

WD = jour de semaine

MM = mois

YY = année

next day = est pris en compte que le lendemain

Touche: **Start of summertime - date  
(Début de l'heure d'été –  
date)**

Entrée la date du passage à l'heure d'été. Cette entrée se réfère au format sélectionné auparavant.

Touche: **Start of summertime - time  
(Début de l'heure d'été –  
heure)**

Entrée l'heure du passage à l'heure d'été.

Touche: **End of summertime -  
format  
(Début de l'heure d'hiver -  
format)**

Sélection de format d'entrer du passage à l'heure d'hiver.

Touche: **End of summertime - date  
(Début de l'heure d'hiver -  
date)**

Entrée la date du passage à l'heure d'hiver. Cette entrée se réfère au format sélectionné auparavant.

Touche: **End of summertime - time  
(Début de l'heure d'hiver –  
heure)**

Entrée l'heure du passage à l'heure d'hiver.

Touche: **Time shifting  
(Décalage horaire)**

Entrée le décalage horaire en heures et minutes lors du passage heure d'été/heure d'hiver.

## Service Functions (Fonctions service)



### REMARQUE!

Pour que le distributeur ou bien le fabricant d'imprimante soit à même d'offrir son soutien, en cas de panne, l'imprimante est équipée avec le menu fonctions service. Les informations nécessaires comme par exemple les paramètres réglés, peuvent être lues directement à l'imprimante. Le menu principal contient des informations supplémentaires comme par exemple la version du firmware ou la version de police.

Touches:

#### Label parameters (Paramètres d'étiquette)

Indication des paramètres étiquette en Volt.

**A:** Indication de la valeur minimale.

**B:** Indication de la valeur maximale.

**C:** Indication de la valeur pour le seuil de commutation qui est déterminé lors de la mesure et peut être modifié.

Touche:

#### Photocell configuration (Réglages des cellules)

Permet de régler les niveaux de la cellule.

En cas de problèmes lors de la mesure ou le positionnement de l'étiquette, entrer les niveaux pour la cellule étiquette manuellement. Assurez-vous d'avoir une amplitude importante (pour l'étiquette >3 V, pour l'espace <1 V).

Touche:

#### Photocell parameters (Paramètres des cellules)

**TLS:** Indication du niveau de la cellule transmission en Volt.

**RLS:** Indication du niveau de la cellule réflexion en Volt.

**SLS:** Indication du niveau de la cellule distributeur en Volt.

**RC:** Indication de l'état de la cellule film transfert (0 ou 1).

**H:** Indication de la valeur 0 ou 1 pour la position de la tête d'impression.

0 = Tête d'impression en bas

1 = Tête d'impression en haut

Touche:

#### Paper counter (Kilométrage)

**D:** Indication du kilométrage de la tête d'impression mètres.

**G:** Indication du kilométrage de la mécanique en mètres.

Touche:

#### Heater resistance (Résistance dot)

Pour obtenir une bonne impression, il faut régler après un changement de la tête d'impression la valeur ohmique indiquée sur la tête d'impression.

Touche:

#### Printhead temperature (Température de la tête d'impression)

Indication de la température de la tête d'impression. Normalement la température de tête d'impression est la même que la température ambiante. Dans le cas où la température de tête d'impression est trop haute, le travail d'impression en cours est interrompu et un message d'erreur est indiqué sur l'écran de l'imprimante.

Touche:

#### Motor ramp (Moteur Rampe)

Cette fonction est souvent réglée en utilisant des vitesses d'impression plus rapides parce qu'on peut éviter le déchirement du film transfert.

Plus la valeur '++' est réglée haut, plus l'avance du moteur accélère lentement.

Plus la valeur '--' est réglée bas, plus l'avance du moteur freine rapidement.

Touche:

#### Print examples (Exemples d'impression)

Tous les réglages du module d'impression ont été imprimés sur l'étiquette insérée.

**Settings (Paramètres):** Impression de tous les paramètres comme par exemple vitesse, matériel d'étiquette et du film transfert etc.

**Bar codes (Codes à barres):** Impression de tous les codes à barres disponibles.

**Fonts (Fonts):** Impression de toutes les polices bitmap et vectoriels.

Touche:

#### Input (Entrée)

Affichage du niveau de signal d'entrée.

0 = Low

1 = High

Touche:

#### Output (Sortie)

Affichage du niveau de signal de sortie.

0 = Low

1 = High

Touche: **I/O status  
(Niveau E/S)**

Des résultats signalétiques sont comptés et protocollés également dans la mémoire RAM. Le protocole se perd après mettre l'appareil hors marche.

**RInt** = Real Interrupts

Les impulsions entrée de démarrage sont comptés directement à l'Interrupt.

**Dbnc** = Debounced

Les impulsions d'entrée de démarrage plus longues que le temps de debounce sont comptées. Seulement ces impulsions de démarrage peuvent conduire à une impression. Si l'impulsion de démarrage est trop courte, pas d'impression est déclenchée. Reconnaissable au fait que RInt est compté, Dbnc pas.

**NPrn** = Not Printed

Les impulsions d'entrée de démarrage sont comptés qui n'ont pas conduit à une impression.

Causes pour cela: aucun ordre d'impression actif, ordre d'impression arrêté (manuellement ou à cause d'une erreur) ou le système d'impression est encore actif avec traiter un ordre d'impression.

**PrtStrtReset** = Réinitialise tous les compteurs.

**PrtStrtTime** = Longueur mesurée de la dernière impulsion de démarrage en ms.

Touche: **Cutter photocell  
(Cellule massicot)**

1 = L'imprimante est équipée avec un massicot.

0 = L'imprimante n'est pas équipée avec un massicot.

**Cellule Home (CH)**

1 = Le massicot se trouve dans la position initiale et est prêt pour couper.

0 = Le massicot ne se trouve pas dans la position initiale et on doit la mettre dans cette position avant le coupage peut être déclenché.

Touche: **Online/Offline  
(Online/Offline)**

Cette fonction est activée par exemple si le film transfert doit être changé. Il permet d'éviter qu'un ordre d'impression soit traité bien que l'imprimante ne soit pas prête. Si cette fonction est active, appuyer sur la touche  pour passer du mode Online au mode Offline. L'état est indiqué à l'écran.

Défaut: Off

**Online:** Les données peuvent être reçues par les interfaces. Les touches du clavier interne ne sont qu'actives que lorsqu'on passe avec la touche  dans le mode Offline.

**Offline:** Les touches de clavier interne sont toujours actives mais les données reçues ne sont plus traitées. Si l'imprimante est encore en mode Online, des nouveaux ordres d'impression peuvent être encore reçus.

Touche: **Transfer ribbon warning  
(Pré-fin film transfert)**

**TRB = Transfer ribbon advance warning (Signal film = Pré-fin film transfert):**

Avant la fin du film transfert, un signal apparaît sur la sortie.

**Warning diameter (Diamètre pré-fin film transfert):**

Réglage du diamètre du rouleau film transfert pour l'avertissement.

Dans le cas où vous entrez une valeur en mm, un signal apparaît sur OUTPUT2 lorsque que le diamètre est atteint (mesuré au rouleau film transfert).

**Ribbon advance warning mode (Mode de pré-fin film transfert):**

**Warning (Avertissement):** Lors de la réalisation du diamètre pré-fin film transfert, la sortie E/S correspondante est fixé.

**Reduced print speed (Vitesse réduite):** La vitesse sur laquelle la vitesse d'impression doit être réduite.

**Error (Erreur):** Le système d'impression s'arrête lors de la réalisation du diamètre pré-fin film transfert avec le message 'trop peu de film transfert'.

**Reduced print speed (Vitesse d'impression réduite):**

Réglage de la vitesse d'impression réduite en mm/s. Cela peut être réglé dans les limites de la vitesse normale.

Touche: **Zero point adjustment  
in Y direction  
(Alignement du point zéro  
en direction Y)**

Indication de la valeur en 1/100 mm.

Après le changement de la tête d'impression, si l'impression ne se fait pas à la même position sur l'étiquette, cette différence peut être corrigée dans la direction d'impression.

**REMARQUE!**

La valeur pour l'alignement du point zéro est ajustée départ usine. Cet alignement ne peut être ajusté à nouveau qu'au changement de la tête d'impression par le personnel de maintenance.

Touche: **Zero point adjustment  
in X direction  
(Alignement du point zéro  
en direction X)**

Indication de la valeur en 1/100 mm.  
Après le changement de la tête d'impression, si l'impression ne se fait pas à la même position sur l'étiquette, cette différence peut être corrigée transversalement à la direction d'impression.

**REMARQUE!**

La valeur pour l'alignement du point zéro est ajustée départ usine. Cet alignement ne peut être ajusté à nouveau qu'au changement de la tête d'impression par le personnel de maintenance.

Touche: **Print length +/-  
(Longueur d'impr. +/-)**

Indication de la correction d'étiquette en pourcent.  
Par des influences mécaniques (par ex. dimension de rouleau) l'imprimante d'Impression peut être imprimé agrandi aussi bien que réduit par rapport à la taille originale.  
Valeurs possibles: +10.0 % ... -10.0 %

Touche: **Write log files on MC  
(Enregistrer fichiers  
journaux sur carte  
mémoire)**

Sur cette commande, différents fichiers d'enregistrement (log) sont enregistrés sur un support de stockage existant (carte mémoire). Après le message 'Terminé', le support de stockage peut être enlevé.

Les fichiers se trouvent dans le répertoire 'log':

**LogMemErr.txt:** Erreurs enregistrées avec des informations supplémentaires comme p. ex. date/heure et nom fichier/numéro ligne (pour des développeurs).

**LogMemStd.txt:** Enregistrement des événements choisis.

**LogMemNet.txt:** Les données dernièrement envoyées par port 9100.

**Parameters.log:** Tous paramètres d'imprimante sous une forme lisible.

**TaskStatus.txt:** Les états de toutes imprimantes des tâches.

**Main Menu (Menu principal)**



















Après la mise en route de l'imprimante, l'écran affiche le menu principal. Ce menu indique informations comme par exemple le type d'imprimante, la date et l'heure actuelle, le numéro de version de logiciel résident utilisé etc.

L'indication sélectionnée n'est indiquée que pour un temps court, ensuite l'affichage retourne à la première information.

Appuyer sur la touche  pour changer au prochain indication.

## Carte Compact Flash / Clé Mémoire USB\*

Le menu mémoire peut être utilisé avec les touches du clavier interne de l'imprimante ou avec les différentes touches de fonction d'un clavier USB connecté.

		Retour au dernier menu.
		Dans la fonction <i>Load layout</i> (Charger layout): Changer dans le File Explorer. File Explorer: Changer dans le context menu (menu contextuel).
		Sélectionner un fichier/un répertoire si une sélection de multiples est possible.
		Menu principal: Sélectionner le menu mémoire. File Explorer: Créer un nouveau fichier.
		Exécuter la fonction actuelle pour le fichier/le répertoire courant.
		Changer dans le répertoire supérieur.
		Changer dans le répertoire actuellement sélectionné.
		Dans le répertoire actuel, défiler vers le haut.
		Dans le répertoire actuel, défiler vers le bas.

### Define user directory (Définir répertoire utilisateur)

Définir un répertoire standard dans lequel se trouvent les fichiers pour le traitement.



#### REMARQUE!

Un répertoire utilisateur doit être défini:

- avant qu'une utilisation et/ou navigation ne doive avoir lieu par le menu mémoire.
- si le formatage de la carte CF a été effectuée au PC et ainsi le répertoire STANDARD n'a pas été créé automatiquement.

```
File Explorer
A:\
[Drives]
-><STANDARD>
<DIR_1>
```

```
Context Menu
A:
->Set as user dir
Format
Copy
```



Accès au menu mémoire.



Appeler le File Explorer.



Sélectionner le répertoire.



Liste des fonctions disponibles.



Sélectionner la fonction *Set as user dir* (comme répertoire d'utilisateur).



Confirmer la sélection.



Retourner au menu principal.

Lors de prochain appel du menu mémoire le répertoire sélectionné est indiqué comme répertoire utilisateur.

### Load layout (Charger layout)

Charger d'un layout dans un répertoire utilisateur spécifié. La fonction permet d'une entrée rapide au layout désiré car seulement des layouts sont listés et les répertoires sont masqués.

```
Load layout
A:\STANDARD
->File_name1.prn
File_name2.prn
File_name3.prn
File_name4.prn
```



Accès au menu mémoire.

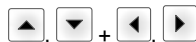

Sélectionner le layout.



Confirmer la sélection.

La fenêtre affiche automatiquement pour entrer le nombre de copies à imprimer.



Sélectionner le nombre des layouts qui doivent être imprimés.



Démarrer l'ordre d'impression.



#### REMARQUE!

Il est IMPOSSIBLE de changer le répertoire ici. Un changement de répertoire DOIT être exécuté dans le File Explorer avec la fonction *Change directory* (Changer répertoire).

\* non disponible



## File Explorer

Le File Explorer est le système d'administration de fichier de l'imprimante. Les fonctions principales pour la surface de menu mémoire sont mises à la disposition dans le File Explorer.

Dans la vue du répertoire utilisateur, appuyer sur la touche **F** pour accéder au File Explorer.

Les fonctions suivantes sont disponibles:







- Changer unité et/ou répertoire
- Charger fichier
- Enregistrer layout et/ou configuration
- Effacer fichier(s)
- Formater la carte CF
- Copier fichier(s)

### Change directory (Changer répertoire)

```
File Explorer
A:\
-----
[Drives]
-><STANDARD>
<DIR_1>

File Explorer
A:\STANDARD\
-----
-><..>
  layout01
  layout02
```





Sélectionner l'unité et/ou le répertoire dans lequel les fichiers sont enregistrés.

-  Accès au menu mémoire.
- F** Appeler le File Explorer.
- ,  + ,  Sélectionner le répertoire.
-  Confirmer la sélection.  
Le répertoire sélectionné est affiché.

### Load file (Charger fichier)

```
Load file
A:\STANDARD\
-----
<..>
->layout01
  layout02
```

Charger un fichier arbitraire. Cela peut être une configuration enregistrée auparavant, un layout, etc.

-  Accès au menu mémoire.
- F** Appeler le File Explorer.
-  +  Sélectionner le fichier.
-  Le fichier sélectionné est chargé.







### REMARQUE!

Si le fichier sélectionné est un layout, le nombre de copies à imprimer peut être indiqué immédiatement.

### Save layout (Enregistrer layout)

```
Save file
A:\STANDARD
-----
->Save layout
  Save config.
  noname
```

Enregistrer le layout chargé sous le nom sélectionné.

-  Accès au menu mémoire.
- F** Appeler le File Explorer.
-  Changer dans le menu *Save file* (Enregistrer fichier).
- ,  Sélectionner la fonction *Save layout* (Enregistrer layout).
-  Confirmer la sélection.

Si un clavier USB est branché, il est possible de donner un nouveau nom de fichier *noname*.

### Save configuration (Enregistrer configuration)

```
Save file
A:\STANDARD
Save layout
→ Save config.
config.cfg
```

Enregistrer la configuration de module d'impression complète sous le nom sélectionné.



Accès au menu mémoire.



Appeler le File Explorer.



Changer dans le menu *Save file* (Enregistrer fichier).



Sélectionner la fonction *Save configuration* (Enregistrer configuration).



Confirmer la sélection.

Si un clavier USB est branché, il est possible de donner un nouveau nom de fichier pour *config.cfg*.

### Delete file (Effacer fichier)

```
File Explorer
A:\STANDARD\
layout01 *
→ layout02 *
layout03
layout04

Context menu
2 objects marked
→ Delete
Copying
```

Effacer irrévocablement un ou plusieurs fichiers ou répertoires. En l'effacement d'un répertoire, les fichiers contenus aussi bien que les sous-répertoires sont effacés.



Accès au menu mémoire.



Appeler le File Explorer.



Sélectionner le fichier.



Sélectionner les fichiers qui doivent être effacés. Les entrées sélectionnées sont marquées avec \*. Répéter ce processus jusqu'à ce que tous les fichiers et/ou répertoires désirés sont marquées pour l'effacement.



Changer dans le context menu (menu contextuel).



Sélectionner la fonction *Delete* (Effacer).



Confirmer la sélection.

### Formatting (Formater)

Formater irrévocablement une carte mémoire.



#### REMARQUE!

Des clés USB ne peuvent pas être formatées au module d'impression directe

```
File Explorer
DRIVES
→ A: 954Mb free
U: No media
```



Accès au menu mémoire.



Appeler le File Explorer.



Sélectionner le lecteur qui doit être formaté.



Changer dans le context menu (menu contextuel).



Sélectionner la fonction *Formatting* (Formater).



Confirmer la sélection.

```
Context menu
A:\
Set as user dir
→ Formatting
Copy
```

## Copying (Copier)

```
File Explorer
A:\STANDARD\
layout01      *
→layout02    *
layout03
layout04
```

```
Context menu
2 objects marked
Delete
→Copying
```

```
Select Destination
DRIVES
→A: 954Mb free
```

Créer une copie du fichier original et/ou du répertoire original pour faire des modifications indépendamment de l'original..



Accès au menu mémoire.



Appeler le File Explorer.



Sélectionner le fichier.



Sélectionner les fichiers qui doivent être copiés. Les entrées sélectionnées sont marquées avec \*. Répéter ce processus jusqu'à ce que tous les fichiers et/ou répertoires désirés sont marqués.



Changer dans le context menu (menu contextuel).



Sélectionner la fonction *Copying* (Copier).



Spécifier la destination du processus de copier.



Sélectionner l'emplacement de destination.



Confirmer la sélection.

## Filtre:

### Possible uniquement si un clavier USB est raccordé.

Si un clavier USB est attaché, avec certaines fonctions on peut indiquer un masque de filtre ou le nom de fichier d'un fichier à enregistrer. Cette entrée est indiquée dans la ligne de chemin. Avec le masque de filtre il est possible de chercher certains fichiers. Par exemple, lors de l'entrée de 'L' seulement des fichiers qui commencent avec 'L' sont indiqués (sensibilité à la casse n'est pas considérée).

#### Sans filtre

```
Load layout
A:\STANDARD
→First_file.prn
Layout_new.prn
Sample.prn
12807765.prn
```

#### Avec filtre

```
Load layout
L
→Layout_new.prn
```

## Données techniques

	Vita II 103/8 T	Vita II 104/8	Vita II 106/12	Vita II 106/24	Vita II 108/12 T
Résolution	203 dpi	203 dpi	300 dpi	600 dpi	300 dpi
Vitesse max. d'impression	200 mm/s	200 mm/s	150 mm/s	100 mm/s	150 mm/s
Largeur d'impression	104 mm	104 mm	105,7 mm	105,7 mm	108,4 mm
Largeur de passage					
Standard	116 mm	116 mm	116 mm	116 mm	116 mm
Mode massicot	112 mm	112 mm	112 mm	112 mm	112 mm
Tête d'impression	Flat Type <sup>1</sup>	Flat Type <sup>2</sup>	Flat Type <sup>2</sup>	Flat Type <sup>2</sup>	Flat Type <sup>1</sup>
<b>Étiquettes</b>					
Étiquettes ou matériel continu sur rouleau ou zig-zag	Papier, Carton, Textile Synthétique				
Max. grammage	220 gr/m <sup>2</sup> (autres sur demande)				
Largeur min. des étiquettes	12 mm				
Hauteur min. des étiquettes					
Standard	5 mm				
Mode massicot/distributeur	15 mm				
Hauteur max. des étiquettes	6000 mm	6000 mm	3000 mm	1000 mm	3000 mm
Diamètre max. de rouleau					
Dérouleur interne	180 mm				
Enrouleur interne	---				
Diamètre mandrin	40 mm / 75 mm (option)				
Sens d'enroulement	externe ou interne				
Cellule de détection	Transmission ou réflexion en bas				
<b>Film transfert</b>					
Couleur	externe ou interne				
Diamètre max. de rouleau	Ø 80 mm				
Diamètre mandrin	25,4 mm / 1"				
Max. longueur	450 m				
Max. largeur	110 mm				
<b>Dimensions (mm)</b>					
Largeur x Hauteur x Profond.	236 x 238 x 374				
Poids	11 kg				
<b>Electronique</b>					
Processeur	High Speed 32 Bit				
Mémoire vive (RAM)	16 MB				
Emplacement	pour carte Compact Flash Type I				
Batterie	pour horloge temps réel (sauvegarde des données lors d'un débranchement de courant)				
Buzzer de signalement	Signal acoustique en cas d'erreur				
<b>Interfaces</b>					
Série	RS-232C (jusqu'à 115200 Baud)				
Parallèle	SPP				
USB	2.0 High Speed Slave				
Ethernet	10/100 Base T, LPD, RawIP-Printing, DHCP, HTTP, FTP				
WLAN (option)	Module 802.11 b/g/n WEP, WPA, WPA-PSK, WPA2, WPA2-PSK, EAP				

<sup>1</sup> = Thermique direct

<sup>2</sup> = Transfert thermique

<b>Fonctionnement</b>	<b>Vita II 103/8 T</b>	<b>Vita II 104/8</b>	<b>Vita II 106/12</b>	<b>Vita II 106/24</b>	<b>Vita II 108/12 T</b>
Tension	110 ... 230 V AC / 50-60 Hz				
Max. puissance	275 VA				
Courant nominal	2,5 A				
Température fonctionnement	5 ... 35 °C				
Max. humidité	max. 80 % (sans condensation)				
<b>Panneau de contrôle</b>					
Touches	Impression test, Menu Fonction; Quantité, Carte CF, Avance, Enter, 4 x Curseur				
Afficheur LCD	Écran 132 x 64 pixel				
<b>Réglages</b>					
	Date, Heure, Horaire d'équipe 20 langues (autres sur demande) Paramètres d'étiquette et d'imprimante, interfaces, mot de passe, variables				
<b>Surveillance</b>					
Arrêt d'impression	Fin de film transfert transfert / Fin d'étiquettes / Tête d'impression ouverte				
Impression d'état	Impression des réglages d'imprimante par ex. la longueur totale d'impression, paramètres des cellules Impression de tous fonts internes et tous codes à barres supportés				
<b>Polices</b>					
Polices	6 polices bitmap 8 polices vectorielles/polices TrueType 6 polices proportionnelles Autres polices sur demande				
Set de caractères	Windows 1250 à 1257, DOS 437, 850, 852, 857, UTF-8 Tous les signes d'Europe de l'Ouest et de l'Est, latins, cyrilliques, grecs et arabes (optionnel) sont supportés. Autres sets de caractères sur demande				
Polices bitmap	Taille en largeur et hauteur 0,8 ... 5,6 Facteur d'agrandissement 2 ... 9 Orientation 0°, 90°, 180°, 270°				
Polices vectorielles/TrueType	Taille en largeur et hauteur 1 ... 99 mm Facteur d'agrandissement illimité Orientation 0°, 90°, 180°, 270°				
Style	Selon la police, gras, italique, inverse, vertical				
Espace entre caractères	Variable				
<b>Codes à barres</b>					
1D codes à barres	CODABAR, Code 128, Code 2/5 interleaved, Code 39, Code 39 extended, Code 93, EAN 13, EAN 8, EAN ADD ON, GS1-128, Identcode, ITF 14, Leitcode, Pharmacode, PZN 7 Code, PZN 8 Code, UPC-A, UPC-E				
2D codes à barres	Aztec Code, CODABLOCK F, DataMatrix, GS1 DataMatrix, MAXICODE, PDF 417, QR Code				
Codes à barres composites	GS1 DataBar Expanded, GS1 DataBar Limited, GS1 DataBar Omnidirectional, GS1 DataBar Stacked, GS1 DataBar Stacked Omnidirectional, GS1 DataBar Truncated				
	Tous les codes sont variables en hauteur, élargissement et ratio Orientation 0°, 90°, 180°, 270° Optionnellement avec clé de contrôle et la ligne lisible en clair				
<b>Logiciels</b>					
Configuration	ConfigTool				
Commande de processus	NiceLabel				
Logiciels d'étiquetage	Labelstar Office Lite, Labelstar Office				
Pilotes Windows	Windows 7® - Windows 10® 32/64 Bit Windows Server 2008® (R2) - Windows Server 2019®				

Modifications techniques sont sous réserves

## Nettoyage



### DANGER!

Danger de mort par choc électrique!

⇒ Couper l'imprimante du secteur avant tous travaux de maintenance et attendre un instant jusqu'à ce que le bloc d'alimentation se soit déchargé.



### REMARQUE!

Il est recommandé de porter un équipement de protection individuelle tel que des lunettes de protection lors du nettoyage de l'appareil.

Type d'entretien	Fréquence
Nettoyage général.	Si besoin.
Nettoyer le rouleau d'entraînement du film transfert.	A chaque changement de film transfert ou lorsque la qualité d'impression est altérée.
Nettoyer le rouleau de pression.	A chaque changement de rouleau d'étiquettes ou lorsque la qualité d'impression est altérée.
Nettoyer la tête d'impression.	<b>Impression thermique directe:</b> A chaque changement de rouleau d'étiquettes. <b>Impression transfert thermique:</b> A chaque changement de film transfert ou lorsque la qualité d'impression est altérée.
Nettoyer la cellule d'étiquettes.	Au changement de rouleau d'étiquettes.



### REMARQUE!

Veuillez observer les recommandations de manipulation pour l'utilisation d'isopropanol (IPA). En cas de contact avec les yeux ou la peau, rincer abondamment à l'eau courante. En cas d'irritation persistante, consulter un médecin. Assurer une ventilation suffisante.



### AVERTISSEMENT!

Risque d'incendie en utilisant un dissolvant d'étiquettes facilement inflammable!

⇒ En utilisant un dissolvant d'étiquettes, l'imprimante sera nettoyée complètement et toutes les poussières devront être enlevées.

## Nettoyage général



### ATTENTION!

L'utilisation des produits nettoyants agressifs peut endommager l'imprimante!

⇒ N'utiliser aucun agent abrasif ou solvant pour le nettoyage des surfaces externes ou des différents éléments.

⇒ Eliminer la poussière et les peluches de papier dans la zone d'impression avec un pinceau souple ou un aspirateur.

⇒ Nettoyer les surfaces externes avec un solvant multi-usages.

## Nettoyer le rouleau d'entraînement

L'encrassement du rouleau d'entraînement peut causer une mauvaise qualité d'impression et peut aussi entraver le transport des matériaux.

- Enlever le couvercle.
- Enlever le film transfert.
- Enlever les dépôts avec un solvant et un chiffon doux.
- Remplacer le rouleau s'il est abimé.

## Nettoyer le rouleau de pression

L'encrassement du rouleau de pression peut causer une mauvaise qualité d'impression et peut aussi entraver le transport des matériaux.



### ATTENTION!

Le rouleau de pression peut être endommagé!

⇒ Ne pas utiliser d'objets coupants, pointus ou durs pour nettoyer le rouleau à tête d'impression.

- Tourner le levier en sens inverse des aiguilles d'une montre pour déverrouiller la tête d'impression.
- Enlever les étiquettes et le film transfert.
- Enlever les dépôts avec un solvant et un chiffon doux.
- Remplacer le rouleau s'il est abîmé.

## Nettoyer la tête d'impression

L'impression peut entraîner une accumulation de poussière sur la tête d'impression, par exemple par des particules de couleur du film transfert, et il est donc nécessaire de nettoyer la tête d'impression à des intervalles réguliers en fonction des heures de fonctionnement, et de l'environnement comme les poussières, etc.



### ATTENTION!

La tête d'impression peut être endommagée!

⇒ Ne pas utiliser d'objets coupants, pointus ou durs pour nettoyer la tête d'impression

⇒ Ne pas toucher la couche de protection en verre de la tête d'imprimante.

- Tourner le levier en sens inverse des aiguilles d'une montre pour déverrouiller la tête d'impression.
- Enlever les étiquettes et le film transfert de l'imprimante.
- Nettoyer la surface de la tête d'impression avec un coton tige ou avec une éponge imbibée d'alcool pur.
- Laisser sécher la tête d'impression 2-3 minutes avant la remise en route de l'imprimante.

## Nettoyer la cellule d'étiquettes



### ATTENTION!

La cellule peut être endommagée!

⇒ Ne pas utiliser d'objets coupants ou durs ou de produit solvant pour nettoyer la cellule.

La cellule d'étiquettes peut être encrassée par la poussière à papier. La reconnaissance du début des étiquettes peut en être perturbée.

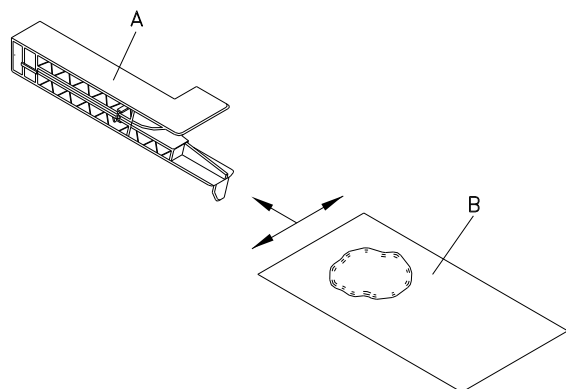

- Tourner le levier dans le sens des aiguilles d'une montre pour déverrouiller la tête d'impression.
- Enlever les étiquettes et le film transfert de l'imprimante.
- Souffler la cellule (A) avec Bombe d'air comprimé. Faire attention des indications sur le bombe.
- Enlever salissures dans la cellule avec une carte à nettoyer (B). Avant de nettoyer, mouillez la carte avec détergent pour tête et rouleau d'impression.
- Réinsérer les étiquettes et le film transfert.





Quick reference guide and  
product safety

English

Copyright by Carl Valentin GmbH.

Information on the scope of delivery, appearance, performance, dimensions, and weight reflect our knowledge at the time of printing.

We reserve the rights to make modifications.

All rights, including those regarding the translation, are reserved.

No part of this document may be reproduced in any form (print, photocopy, or any other method) or edited, copied, or distributed electronically without written permission from Carl Valentin GmbH.

Due to the constant further development of our devices discrepancies between manual and device can occur.

Please check [www.carl-valentin.de](http://www.carl-valentin.de) for the latest update.

### Trademarks

All named brands or trademarks are registered brands or registered trademarks of their respective owners and may not be separately labelled. It must not be concluded from the missing labelling that it is not a registered brand or a registered trademark.

Carl Valentin label printers comply with the following safety guidelines:

- CE** Low-Voltage Directive (2014/35/EU)
- Electromagnetic Compatibility Directive (2014/30/EU)



### Carl Valentin GmbH

Postfach 3744  
78026 Villingen-Schwenningen  
Neckarstraße 78 – 86 u. 94  
78056 Villingen-Schwenningen

Phone +49 7720 9712-0  
Fax +49 7720 9712-9901

E-Mail [info@carl-valentin.de](mailto:info@carl-valentin.de)  
Internet [www.carl-valentin.de](http://www.carl-valentin.de)

---

## Contents

Intended Use	92
Safety Notes	92
Environmentally-Friendly Disposal	92
Operating Conditions	93
Unpack the Label Printer	96
Scope of Delivery	96
Set up the Label Printer	96
Connect the Label Printer	96
Initial Operation of the Label Printer	96
Load Label Roll in Tear-off Mode	97
Load Transfer Ribbon	98
Print Settings	99
Label Layout	99
Device Settings	100
Network	102
Password	102
Interface	103
Emulation	103
Date & Time	104
Service Functions	105
Main Menu	107
Compact Flash Card	108
Technical Data	112
Clean the Transfer Ribbon Drawing Roller	114
Clean the Pressure Roller	115
Clean the Printhead	115
Clean the Label Photocell	115

---

## Intended Use

- The label printer is a state-of-the-art device which complies with the recognized safety-related rules and regulations. Despite this, a danger to life and limb of the user or third parties could arise and the label printer or other property could be damaged while operating the device.
- The label printer may only be used while in proper working order and for the intended purpose. Users must be safe, aware of potential dangers and must comply with the operating instructions. Faults, in particular those which affect safety, must be remedied immediately.
- The label printer is solely intended to print suitable media which have been approved by the manufacturer. Any other or additional use is not intended. The manufacturer/supplier is not liable for damage resulting from misuse. Any misuse is at your own risk.
- Intended use includes heeding the operating manual, including the maintenance recommendations/regulations specified by the manufacturer.

## Safety Notes

- The label printer is designed for power supply systems from 110 ... 230 V AC. Connect the label printer only to electrical outlets with a ground contact.
- Couple the label printer to devices using extra low voltage only.
- Before making or undoing connections, switch off all devices involved (computer, printer, accessories etc.).
- Operate the label printer in a dry environment only and do not get it wet (sprayed water, mist etc.).
- Maintenance and servicing work can only be carried out by trained personnel.
- Operating personnel must be trained by the operator on the basis of the operating manual.
- If the label printer is operated with the cover open, ensure that clothing, hair, jewellery and similar personal items do not contact the exposed rotating parts.
- The print unit and parts of it (e.g. printhead) can get hot during printing. Do not touch the printhead during operation. Cool down the print unit before changing material, removal or adjustment.
- Never use highly inflammable consumables.
- There is a risk of injury at the tear-off edge. If the tear-off edge is not used, attach the edge protection profile.
- Carry out only the actions described in these operating instructions. Any work beyond this may only be performed by the manufacturer or upon agreement with the manufacturer.
- Unauthorized interference with electronic modules or their software can cause malfunctions.
- Other unauthorized work or modifications to the direct print module can endanger operational safety.
- Always have service work done in a qualified workshop, where the personnel have the technical knowledge and tools required to do the necessary work.
- There are warning stickers on the direct print modules that draw your attention to dangers. Therefore the warning stickers are not to be removed as then you and others cannot be aware of dangers and may be injured.



### DANGER!

Danger to life and limb from power supply!

⇒ Do not open the casing.



### NOTICE!

**For Norway and Sweden:** Devices which are attached via a power connector with a connection to safety earthing to the safety earthing of the electric equipment of the building and to a cable distribution system with coaxial cables can cause fire risks under certain circumstances. Therefore the connection with a cable distribution system must be made by a device which provides an electric insulation underneath a specific frequency range.

## Environmentally-Friendly Disposal

Manufacturers of B2B equipment are obliged to take back and dispose of old equipment that was manufactured after 13 August 2005. As a principle, this old equipment may not be delivered to communal collecting points. It may only be organised, used and disposed of by the manufacturer. Valentin products accordingly labelled can therefore be returned to Carl Valentin GmbH.

This way, you can be sure your old equipment will be disposed of correctly.

Carl Valentin GmbH thereby fulfils all obligations regarding timely disposal of old equipment and facilitates the smooth reselling of these products. Please understand that we can only take back equipment that is sent free of carriage charges.

The electronics board of the printing system is equipped with a battery. This must only be discarded in battery collection containers or by public waste management authorities.

Further information on the WEEE directive is available on our website [www.carl-valentin.de](http://www.carl-valentin.de).

## Operating Conditions

Before initial operation and during operation these operating conditions have to be observed to guarantee safe and interference-free service of our printers.

Therefore please carefully read these operating conditions.

As the delivery is customised, please compare the supplied accessories with your order.

## General Conditions

Shipment and storage of our printers are only allowed in original packing.

Installation and initial operation of printer is only allowed if operating conditions were fulfilled.

Initial operation, programming, operation, cleaning and service of our printers are only recommended after careful study of our manuals.

Operation of printer is only allowed by especially trained persons.



### NOTICE!

Perform trainings regularly.

Content of the training are the chapters 'Operating Conditions', 'Loading Media' and 'Maintenance and Cleaning'.

These indications are also valid for someone else's equipment supplied by us.

Only use original spare and exchange parts.

Please contact the manufacturer with respect to spare/wear parts.

## Conditions for Installation Place

The installation place of printer should be even, free of vibration and currents of air are to be avoided.

The printers have to be installed to ensure optimal operation and servicing.

## Installation of Power Supply

The installation of the power supply to connect our printers has to be effected according to the international rules and regulations, especially the recommendations of one of the three following commissions:

- International Electronic Commission (IEC)
- European Committee for Electro technical Standardisation (CENELEC)
- Verband Deutscher Elektrotechniker (VDE)

Our printers are constructed according to VDE and have to be connected to a grounded conductor. The power supply has to be equipped with a grounded conductor to eliminate internal interfering voltage.

## Technical Data of Power Supply

Power line voltage and power line frequency:	see type plate
Allowable tolerance of power line voltage:	+6 % ... -10 % of nominal value
Allowable tolerance of power line frequency:	+2 % ... -2 % of nominal value
Allowable distortion factor of power line voltage:	≤ 5 %

### Anti-Interference measures:

In case your net is infected (e.g. by using thyristor controlled machines) anti-interference measures have to be taken. You can use one of the following possibilities:

- Provide separate power supply to our printers.
- In case of problems please connect capacity-decoupled isolation transformer or similar interference suppressor in front of our printers.

## Stray Radiation and Immunity from Disturbance

Emitted interference according to EN 61000-6-3: 2007 industrial sector

- Interference voltage to wires according to EN 55022: 09-2003
- Interference field power according to EN 55022: 09-2003
- System perturbation according to EN 61000-3-2: 09-2006
- Flicker according to EN 61000-3-3: 1955 + A1:2001 + A2:2005

Immunity to interference according to EN 61000-6-2: 2005 industrial sector

- Electromagnetic fields according to EN 61000-4-3: 11-2003, ENV 50204: 03-1995
- Fast transient burst according to EN 61000-4-4: 07-2005
- Surge according to EN 61000-4-5: 12-2001
- High-frequency voltage according to EN 61000-4-6: 12-2001
- Voltage interruption and voltage drop according to EN 61000-4-11: 02-2005



### NOTICE!

This is a machine of type A. This machine can cause interferences in residential areas; in this case it can be required from operator to accomplish appropriate measures and be responsible for it.

## Connecting Lines to External Machines

All connecting lines have to be guided in shielded lines. Shielding has to be connected on both sides to the corner shell.

It is not allowed to guide lines parallel to power lines. If a parallel guiding cannot be avoided a distance of at least 0.5 m has to be observed.

Temperature of lines between: -15 ... +80 °C.

It is only allowed to connect devices which fulfil the request 'Safety Extra Low Voltage' (SELV). These are generally devices which are checked corresponding to EN 60950/EN 62368-1.

## Installation of Data Lines

The data cables must be completely protected and provide with metal or metallised connector housings. Shielded cables and connectors are necessary, in order to avoid radiant emittance and receipt of electrical disturbances.

Allowable lines

Shielded line:                    4 x 2 x 0,14 mm<sup>2</sup> ( 4 x 2 x AWG 26)  
    6 x 2 x 0,14 mm<sup>2</sup> ( 6 x 2 x AWG 26)  
    12 x 2 x 0,14 mm<sup>2</sup> (12 x 2 x AWG 26)

Sending and receiving lines have to be twisted in pairs.

Maximum line length:        with interface V 24 (RS232C) - 3 m (with shielding)  
    with parallel interface - 3 m (with shielding)  
    with USB - 3 m  
    with Ethernet - 100 m

## Air Convection

To avoid inadmissible heating, free air convection has to be ensured.

---

## Limit Values

Protection according IP:	20
Ambient temperature °C (operation):	min. +5 max. +35
Ambient temperature °C (storage):	min. -20 max. +60
Relative air humidity % (operation):	max. 80
Relative air humidity % (storage):	max. 80 (bedewing of printers not allowed)

## Guarantee

We do not take any responsibility for damage caused by:

- Ignoring our operating conditions and operating manual.
- Incorrect electric installation of environment.
- Building alterations of our printers.
- Incorrect programming and operation.
- Not performed data protection.
- Using of not original spare parts and accessories.
- Natural wear and tear.

When (re)installing or programming our printers please control the new settings by test running and test printing. Herewith you avoid faulty results, reports and evaluation.

Only specially trained staff is allowed to operate the printers.

Control the correct handling of our products and repeat training.

We do not guarantee that all features described in this manual exist in all models. Caused by our efforts to continue further development and improvement, technical data might change without notice.

By further developments or regulations of the country illustrations and examples shown in the manual can be different from the delivered model.

Please pay attention to the information about admissible print media and the notes to the printer maintenance, in order to avoid damages or premature wear.

We endeavoured to write this manual in an understandable form to give and you as much as possible information. If you have any queries or if you discover errors, please inform us to give us the possibility to correct and improve our manual.

## Unpack the Label Printer

- ⇒ Lift the label printer on the bottom and remove the printer from the carton.
- ⇒ Check the label printer for transport damages.
- ⇒ Check delivery for completeness.

## Scope of Delivery

- Label printer.
- Empty core, mounted on the transfer ribbon rewinder.
- Tear-off edge (basic printers only).
- Dispensing edge (printers with dispenser option only).
- Power cable.
- Documentation.
- Printer driver CD.
- Labelstar Office LITE.



### NOTICE!

Retain the original packaging for subsequent transport.

## Set up the Label Printer



### CAUTION!

The label printer and the print media can be damaged by moisture and water.

- ⇒ Set up the label printer only in a dry place protected from sprayed water.
- ⇒ Set up the label printer on a level, vibration-free and air draught-free surface.
- ⇒ Open the cover of label printer.
- ⇒ Remove the foam transportation safeguards near the printhead.

## Connect the Label Printer

The printer is equipped with a versatile power supply unit. The device may be operated with a mains voltage of 110 ... 230 V AC / 50-60 Hz without any adjustments or modifications.



### CAUTION!

The label printer can be damaged by undefined switch-on currents.

- ⇒ Set the power switch to '0' before plugging in the label printer.
- ⇒ Insert the power cable into the power connection socket.
- ⇒ Insert the plug of power cable into a grounded electrical outlet.



### NOTICE!

Insufficient or missing grounding can cause faults during operation.

Ensure that all computers and connection cables connected to the label printer are grounded.

- ⇒ Connect the label printer to a computer or network with a suitable cable.

## Initial Operation of the Label Printer

- ⇒ After all connections are completed, switch on the label printer. The main menu appears which shows the printer type, current date and time.
- ⇒ Insert label material and transfer ribbon.
- ⇒ Start measuring in the menu *Label layout/Measure label*.
- ⇒ Press the key  to finish measuring.



### NOTICE!

To enable correct measuring, at least two completed labels have to be passed through (not for continuous labels).

During measuring the label and gap length small differences can occur. Therefore the values can be set manually in menu *Label layout/Label and Gap*.



## Load Label Roll in Tear-off Mode

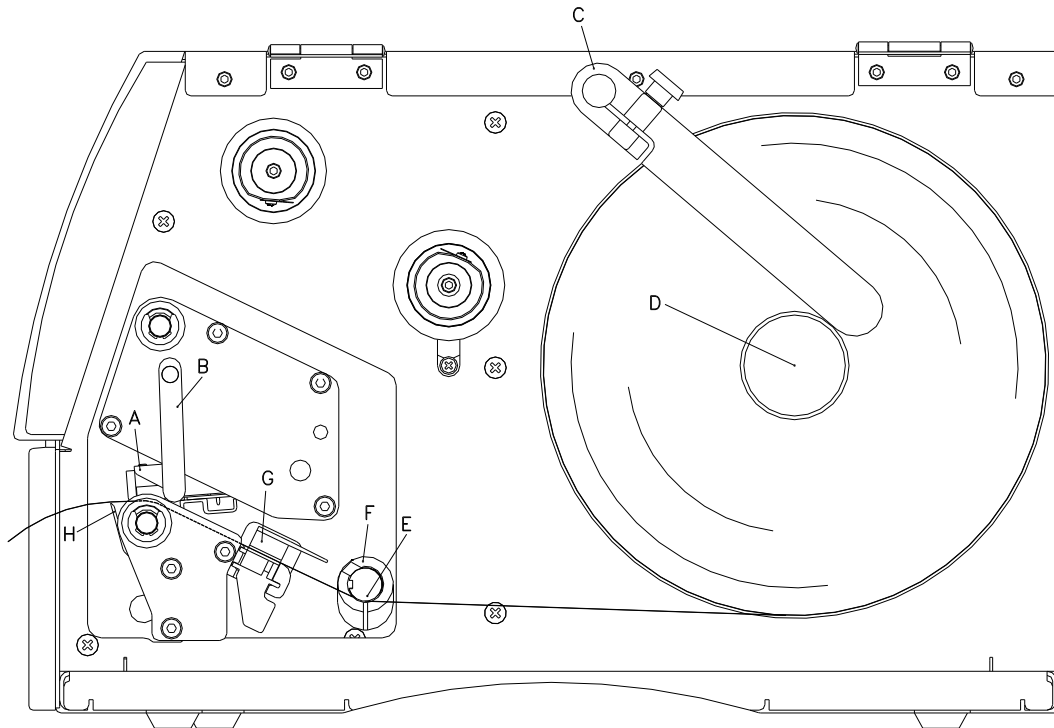

- Open the printer cover.
- Open the printhead (G) by turning the red pressure lever (F) anticlockwise.
- Remove the outside label mounting plate (A).
- Load the label roll with inner winding onto the unwinding roll (B) and attach again the label mounting plate (A).
- Lead the label material below the return pulley (C) and the printhead (G). Pay attention that the label runs through the photocell (E).
- In order to move the printhead (G) down, turn the red pressure lever (F) in clockwise direction until it locks.
- The tear off edge (H) is visible in front of the printhead.
- Enter the offset value in the menu *Print settings/Tear-off*.
- Adjust the adjusting ring (D) of the return pulley (C) to the width of material.
- Close the printer cover.

## Load Transfer Ribbon



### NOTICE!

For the thermal transfer printing method it is necessary to load a ribbon, otherwise when using the printer in direct thermal print it is not necessary to load a ribbon. The ribbons used in the printer have to be at least the same width as the print media. In case the ribbon is narrower than the print media, the printhead is partly unprotected and this could lead to early wear and tear.

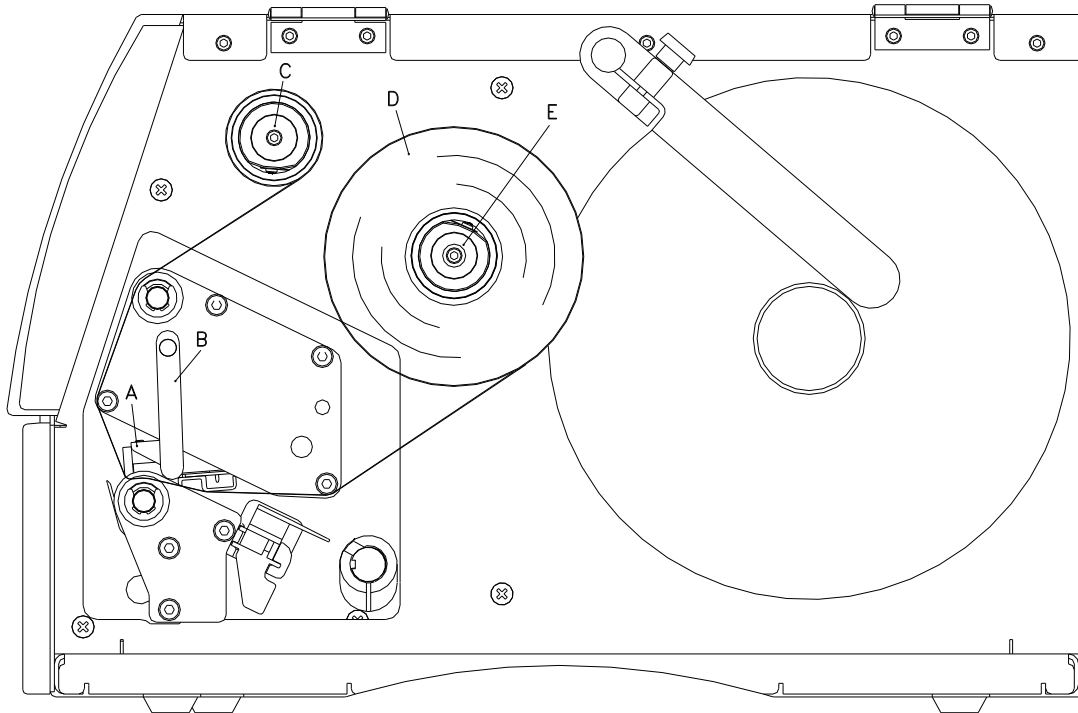

### NOTICE!

Before a new transfer ribbon roll is loaded, the printhead must be cleaned using printhead and roller cleaner (97.20.002).

The handling instructions for the use of Isopropanol (IPA) must be observed. In the case of skin or eye contact, immediately wash off the fluid thoroughly with running water. If the irritation persists, consult a doctor. Ensure good ventilation.

- Clean the printhead before loading the transfer ribbon.
- Open the printer cover.
- Open the printhead (E) by turning the red pressure lever (D) anticlockwise.



### CAUTION!

Risk of scraping when inserting the transfer ribbon res. when removing the used transfer ribbon!

⇒ Be careful with the spring steel plate edges!

- Load the transfer ribbon roll (B) with outer winding onto the unwinding roll (C).
- Place an empty ribbon roll onto the rewinding roll (A) and lead the transfer ribbon below the printhead (E).
- Fix the ribbon with an adhesive tape in rotating direction at the empty roll of the rewinding roll (A). Pay attention to the rotation direction of transfer ribbon rewinder anticlockwise.
- In order to move the printhead (E) down, turn the red pressure lever (D) in clockwise direction until it locks.
- Close the printer cover.



### NOTICE!

As for the electrostatic unloading the thin coating of the thermal printhead or other electronic parts can be damaged, the transfer ribbon should be antistatic.

The use of wrong materials can lead to printer malfunctions and the guarantee can expire.



### CAUTION!

Impact of static material on people!

⇒ Use antistatic transfer ribbon, because static discharge can occur when removing.

## Print Settings

Keys: , 

### Speed

Indication of print speed in mm/s.  
Value range: 50 mm/s ... 200 mm/s (see the technical data).

### Contrast

Indication of value to set the print intensity when using different materials, print speeds or printing contents.  
Value range: 10 % ... 200 %.

Key: 

### Transfer ribbon control

Examination if the transfer ribbon roll is to end or if the ribbon was torn at the unwinding roll.  
**Off:** The ribbon control is deselected, i.e. the printer continues without an error message.  
**On, weak sensibility:** The current print order is interrupted and an error message appears at the printer display. The printer reacts at approx. 1/3 more slowly to the end of the transfer ribbon (default).  
**On, strong sensibility:** The current print order is interrupted and an error message appears at the printer display. The printer reacts immediately to the end of the transfer ribbon.

Key: 

### Y displacement

Indication of initial point displacement in mm.  
Value range: -30.0 ... +90.0.

Key: 

### X displacement

Displacement of the complete print transverse to the paper direction.  
Value range: -90.0 ... +90.0.

Key: 

### Tear off

Indication of value to which the last label of a print order is moved forward and is moved back to the beginning of label at a new print start.  
Value range: 0 ... 50.0 mm  
Standard: 12 mm.

## Label Layout

Keys: , , 

### Label length

Indication of label length in mm.  
Minimum height: 5 mm (dispenser mode: 25 mm).

### Gap length

Indication of distance between two labels in mm.  
Minimum value: 1 mm.

Key: 

### Column printing

Indication of width of one label as well as how many labels are placed side by side.

Key: 

### Measure label

Press key  to start measuring.

Key: 

### Label type

Generally adhesive labels are set. Press key  to select continuous labels.

Key: 

### Material selection

Selection of the used label and transfer ribbon material.

Key: 

### Photocell

Selection of the used photocell.  
The selection of one of the following photocell types is possible: transmission photocell normal and inverse, reflexion photocell normal and inverse, ultrasonic photocell (option).

### Scan position (AP)

Entry of percental label length by that the label end is searched.

Key: **Label error length**

In case an error occurs, indication after how many mm a message appears in the display.  
Value range: 1 ... 999 mm

**Synchronization**

**On:** If a label is missed on the liner an error message is displayed.  
**Off:** Missing labels are ignored, i.e. it is printed into the gap.

Key: **Flip label**

The axis of reflection is in the middle of the label. If the label width was not transferred to the printer, automatically the default label width i.e. the width of the printhead is used. It is recommended to use labels with the same width as the printhead. Otherwise this can cause problems in positioning.

Key: **Rotate label**

According to standard the label is printed ahead with a rotation of 0°. If the function is activated, the label is rotated by 180° and printed in reading direction.

Key: **Rotate label in degrees**

Corresponding to the parameter Rotate label, the label can be turned in 90° steps.

**NOTICE!**

Only printer internal objects (text, lines and barcodes) can be turned. The rotation of graphics is not possible.

Key: **Alignment**

The adjustment of label is effected only after 'flip/rotate label', i.e. the adjustment is independent of the functions flip and rotate label.

**Left:** The label is aligned at the left-most position of printhead.

**Centre:** The label is aligned at central point of printhead.

**Right:** The label is aligned at right-most position of printhead.

**Device Settings**Keys: , , , **Field handling**

**Off:** The complete print memory is deleted.

**Keep graphic:** A graphic res. a TrueType font is transferred to the printer once and stored in the printer internal memory. For the following print order only the modified data is transferred to the printer. The advantage is the saving of transmitting time for the graphic data.

The graphic data created by the printer itself (internal fonts, bar codes, ...) is generated only if they were changed. The generating time is saved.

**Delete graphic:** The graphics res. TrueType fonts stored in the printer-internal memory is deleted but the other fields are kept.

**Restore graphic:** At the end of the print order the printed order can again be started at the printer. All graphics and TrueType fonts are again printed.

**NOTICE!**

**Exception:** With column printing always full columns must be printed (number of pieces always multiple of the columns). Deleted columns are not restored.

Key: **Codepage**

Indication of the font used in the printer. The following possibilities are available:  
Codepage 437, Codepage 850, Codepage 852, Codepage 857, Codepage 1250, Codepage 1251, Codepage 1252, Codepage 1253, Codepage 1254, Codepage 1257, WGL4.

Please find the tables referring to the above mentioned character sets on our website.

Key: **External parameters**

**Label dimension only:** The parameters for label length, gap length and label width can be transferred to the printer. All other parameter settings are to be made directly at the printer.

**On:** Sending parameters such as print speed and contrast via our label creation software to the printer. Parameters which are set directly at the printer before are no longer considered.

**Off:** Only settings made directly at the printer are considered.

Key: **Buzzer****On:** An acoustic signal is audible when pressing a key.

Value range: 1 ... 7.

**Off:** No signal is audible.**Display**

Setting of display contrast.

Value range: 45 ... 75.

Key: **Printer language**

Selection of language in which you want to display the text in the printer display.

At the moment the following languages are available: German, English, French, Spanish, Finnish, Czech, Portuguese, Dutch, Italian, Danish, Polish, Greek, Hungarian, Russian, Chinese (option), Ukrainian, Turkish, Swedish, Norwegian, Estonian.

Key: **Keyboard layout**

Selection of region for the desired keyboard layout.





The following possibilities are available: Germany, England, France, Greece, Spain, Sweden, US and Russia.

Key: **Customized entry****Off:** No question appears at the display. In this case the stored default value is printed.**On:** The question referring the customized variable appears once before the print start at the display.**Auto:** The questions referring the customized variable and the quantity query appear after every printed layout.**Auto without quantity query:** The question referring the customized variable appears after every layout without additional query for the quantity.Key: **Hotstart****On:** Continue an interrupted print order after switching on the printer anew.**Off:** After switching off the printer the complete data is lost.Key: **Autoload****On:** A label which was loaded once from Compact Flash card can be loaded again automatically after a restart of printer.

The last loaded label from CF card is always again loaded after a restart of printer.



**Off:** After a restart of printer the last used label must be again loaded manually from the memory card.

A common use of the functions Autoload and Hotstart is not possible.





Key: **Manual reprint****Yes:** In case an error occurred and printer is in stopped mode then you can reprint the last printed labels by means of keys  and .**No:** Only blank labels were advanced.Key: **Backfeed/Delay****Backfeed:** The backfeed was optimised in the operating modes dispenser (optional) and cutter (optional). Now, when driving into the offset, the following label is 'pre-printed' if possible and therefore the backfeed of label is no necessary and time can be saved.**Delay:** The adjustable deceleration time is only for mode *Backfeed automatic* of importance.Key: **Label confirmation****On:** A new print order is only printed after confirmation at the device.

An already active continuing print order is printed as long as the confirmation is effected at the device.

**Off:** No query appears at the display of control unit.Key: **Standard label****On:** If a print order is started without previous definition of label, the standard label is printed.**Off:** If a print order is started without previous definition of label, an error message appears in the display.

Key: **Synchronization at switching on****Off:** The synchronization is disabled, i.e. the measuring and label feed have to be released manually.**Measure:** After switching on the printer, the loaded label is automatically measured.**Label feed:** After switching on the printer the label is synchronised to the beginning of label. For this one or multiple labels are advanced.Key: **CMI length**

If the print is interrupted in the label, at the printhead this could lead to a small interruption in the printout, showing a fine white line onto the label. To avoid this, a value for the minimum backfeed can be set (0 – 1 mm) at which the label material is moved backwards. At the next print start the free range is overprinted. The setting of CMI length has only an influence at the selection of backfeed mode 'optimised backfeed'.

**Network**Keys: , , , , 

For more information, please see the separate manual.

**Password**Keys: , , , , , **Operation****Password**

Entering a 4-digit numeric password.

Key: **Protection configuration**

Printer settings can be changed (contrast, speed, operating mode, ...). The password protection prevents modifications at the printer settings.

Key: **Protection favorites**

The password protection prevents the access to the favorites.

Key: **Protection memory card**

With the functions of the memory card, labels can be stored, loaded, etc. The password protection has to decide if no access or only readable access on CF card is allowed.

**No protection:** No password protection**Userview only:** Only reading access**Protected:** Access blockedKey: **Protection printing**

In case the printer is connected to a PC, it can be useful, that the user is not able to produce a print manually. So the password protection prevents that prints can be produced manually.

**Network****Password**

Entering a 15-digit password. The password can consists of alphanumeric and special characters.

Key: **Protection HTTP**

The communication by HTTP can be avoided.

Key: **Protection Telnet**

The settings of the Telnet service cannot be changed.

Key: **Protection remote access** The password protection prevents the remote control of the printer.**NOTICE!**

In order to execute a blocked function, first of all the valid password has to be entered. If the correct password is entered then the desired function can be executed.

**Interface**Keys: , , , , , , , **COM1 / Baud / P / D / s****COM1:**

- 0 - serial interface Off
- 1 - serial interface On
- 2 - serial Interface On; no error message occurs in case of a transmission error.

**Baud rate:**

Indication of bits which are transferred per second.

Following values are possible: 1200, 2400, 4800, 9600, 19200, 38400, 57600 and 115200.

**P = Parity:**

- N - No parity
- E - Even
- O - Odd

Please observe that the settings correspond to those of the printer.

**D = Data bits**



Setting of data bits.

Value range: 7 or 8 Bits.



**S = Stop bits**

Indication of stop bits between bytes.



Value range: 1 or 2 stop bits.

Key: **Start sign / End sign****SOH:** Start of data transfer block → Hex format 01**ETB:** End of data transfer block → Hex format 17Key: **Data memory****Standard:** After starting a print order the printer buffer receives data as long as it is filled.**Advanced:** During a current print order data is received and processed.**Off:** After starting a print order no more data is received.Key: **Port test**

Check whether the data are transferred via the interface.

Press the  and  keys to select standard (on). Press the  key and the data sent via any port (COM1, LPT, USB, TCP/IP) is printed.

**Emulation**Keys: , , , , , , , , **Protocol****CVPL:** Carl Valentin Programming Language**ZPL:** Zebra® Programming Language

Press keys  and  to select the protocol. Press key  to confirm the selection. The printer is restarted and ZPL II® commands are transformed internally into CVPL commands.

Key: **Printhead resolution**

At activated ZPL II® emulation the printhead resolution of the emulated device must be set.

**NOTICE!**

If the printhead resolution of the Zebra® printer differs from that of the Valentin device, then the size of objects (e.g. texts, graphics) complies not exactly.

Key: **Drive mapping**

The access to Zebra® drives is rerouted to the corresponding Valentin drives.

**NOTICE!**





As the build-in fonts in Zebra® printers are not available in Valentin devices this can cause small differences in the text image.

Key: **PJL (Printer Job Language)**

Status information regarding the print order can be indicated.

**Date & Time**Keys:          **Set date and time**

The upper line of display shows the current date, the second line the current time.

With keys  and  you can change to the next or previous field. With keys  and  you can increase and/or decrease the displayed values.Key: **Summertime****On:** Printer automatically adjust clock for daylight saving changes.**Off:** Summertime is not automatically recognized and adjusted.Key: **Start of summertime (format)**

Select the format in which you want to define beginning summertime.

DD = day

WW = week

WD = weekday

MM = month,

Y = year

next day = only next day is taken into consideration

Key: **Start of summertime (date)**

By means of this function you can enter the date at which summertime has to start. This entry refers to the previously selected format.

Key: **Start of summertime (time)**

By means of this function you can define the time when you want to start summertime.

Key: **End of summertime (format)**

Select the format in which you want to define end of summertime.

Key: **End of summertime (date)**

By means of this function you can define the date when you want to stop summertime. The entry refers to the previously selected format.

Key: **End of summertime (time)**

By means of this function you can define the time when you want to stop summertime.

Key: **Time shifting**

By means of this function you can enter time shifting in hours and minutes (for automatically adjustment from summer and wintertime). This entry refers to the currently set printer time.



## Service Functions



### NOTICE!

So that the distributor res. the printer manufacturer at the case of service can offer fast support, the printer is equipped with the Service functions menu.  
Necessary information such as set parameter can read directly at the printer (see chapter 6.10 on page 53).

Keys: **F**, , , , , , , , , , 

#### Label parameters

Indication of label parameters in Volt.

**A:** Indication of minimum value.

**B:** Indication of maximum value.

**C:** Indication of trigger level. The value is ascertained while measuring and can be changed.

Key: 

#### Photocell configuration

This function enables definition of photocell levels.

In case of problems while positioning or measuring of label, levels for label photocell can be set manually. Make sure that a large hub as possible (label >3 V, gap <1 V) is set.

Key: 

#### Photocell parameters

**TLS:** Indication of transmission photocell level in Volt.

**RLS:** Indication of reflexion photocell level in Volt.

**SLS:** Indication of peel off photocell level in Volt.

**RC:** Indication of transfer ribbon photocell status (either 0 or 1).

**H:** Indication of printhead position.

0 = printhead down

1 = printhead up

Key: 

#### Paper counter:

**D:** Indication of printhead attainment in meters.

**G:** Indication of printer attainment in meters.

Key: 

#### Heater resistance

To achieve a high print quality, the indicated Ohm value must be set after replacing the printhead.

Key: 

#### Printhead temperature

Indication of printhead temperature. The printhead temperature corresponds normally to the room temperature. In case the maximum printhead temperature is exceeded, the current print order is interrupted and an error message appears at the printer display.

Key: 

#### Motor Ramp

This function is often used for high printing speed as the tearing of transfer ribbon can be prevented.

The higher the '++' value is set, the slower the feeding motor is accelerated.

The smaller the '--' value is set, the faster the feeding motor is decelerated.

Key: 

#### Print examples

**Settings:** Printout of all printer settings such as speed, label and transfer ribbon material.

**Bar codes:** Printout of all available bar code types.

**Fonts:** Printout of all available font types.

Key: 

#### Input

Indication of input signal level.

0 = Low

1 = High

Key: 

#### Output

Indication of input output level

0 = Low

1 = High

Key: **I/O status**

Relevant results are counted and registered in RAM memory. The protocols get lost after switching off the device.

**RInt** = Real Interrupts

The start input impulses are counted directly at the Interrupt.

**Dbnc** = Debounced

The start input impulses that are longer than the set debounce time are counted. Only these start impulses can lead to a print. If a start impulse is too short, no print is released. This is recognized by the fact that RInt is counted, Dbnc not.

**NPrn** = Not Printed

The debounced start input impulses that have not lead to a print are counted. Causes: no active print order, print order stopped (manually or because of an error) or the printing system is still active with the processing of a print order.

**PrtStrtReset** = The counters are reset.

**PrtStrtTime** = Measured length of the last start impulse in ms.

Key: **Cutter photocell**

1 = Printer is equipped with a cutter

2 = Printer is not equipped with a cutter

**Cutter Home (CH)**

1 = The cutter is in the initial position and ready for the cutting procedure.

0 = The cutter is not in the initial position. Before you are going to release a cutting procedure you first have to place the cutter in its initial position.

Key: **Online/Offline**

This function is activated e.g. if the transfer ribbon is to be changed. It is avoided that a print order is processed although the module is not ready. If the function is activated then press the key  to change between Online and Offline mode. The respective state is indicated in the display (Standard: Off).

**Online:** Data can be received by interface. The keys of the foil keyboard are only active, if you changed in the Offline mode with key .

**Offline:** The keys of the foil keyboard are still active but received data are not processed. If the module is again in Online mode then new print orders can be again received.

Key: **Transfer ribbon advance warning**

**TRB = Transfer ribbon advance warning:**

Before the end of transfer ribbon, a signal is sent by the control output.

**Warning diameter:**

Setting of transfer ribbon advance warning diameter.

In case you enter a value in mm then a signal appears via control output when reaching this diameter (measured at transfer ribbon roll).

**Ribbon advance warning mode:**

**Warning:** When reaching the transfer ribbon advance warning diameter, the corresponding I/O output is set.

**Reduced print speed:** Speed on which the printing speed is to be reduced.

**Error:** The printing system stops when reaching the transfer ribbon advance warning diameter with the message 'too less ribbon'.

**Reduced print speed:**

Setting of the reduced print speed in mm/s. This can be set in the limits of the normal print speed.

Key: **Zero point adjustment in Y direction**

Indication of value in 1/100 mm.

After replacing the printhead - the print cannot be continued at the same position on the label, the difference can be corrected in printing direction.

**NOTICE!**

The value for zero point adjustment is set ex works. After replacing the printhead, only service personnel are allowed to set this value anew.

Key: **Zero point adjustment in X direction**

Indication of value in 1/100 mm.

After replacing the printhead - the print cannot be continued at the same position on the label, the difference can be corrected across the printing direction.

**NOTICE!**

The value for zero point adjustment is set ex works. After replacing the printhead, only service personnel are allowed to set this value anew.

Key: 

#### Print length +/-

Indication of print layout correction in percent.  
By mechanical influences (e.g. label roll size) the print layout can be printed increased and reduced to its original size.  
Value range: +10.0 % ... -10.0 %

Key: 

#### Write log files on MC

With this command, different log files are saved on an existing storage medium (memory card). After the 'Finish' message the storage medium can be removed.

The files are in directory 'log':

**LogMemErr.txt:** Logged errors with additional information such as date/time and file name/line number (for developers).

**LogMemStd.txt:** Logging of selected events.

**LogMemNet.txt:** Data latest send via port 9100.

**Parameters.log:** All printer parameters in human readable form.

**TaskStatus.txt:** Status of all printer tasks.

## Main Menu



















Switch on the label printer and the display shows the main menu. The main menu shows information such as printer type, current date and time, version number of firmware and the used FPGA.

The selected display is shown for a short time, then the indication returns to the first information.

Press key  to arrive the next information display.

## Compact Flash Card / USB Memory Stick\*

The memory menu is operated with the keys of the internal foil keyboard of the label printer or with different function keys of an attached USB keyboard.

		Return to the previous menu.
		Function <i>Load layout</i> : Change to the File Explorer. File Explorer: Change to the 'context menu'.
		Select a file/directory if a multiple selection is possible.
		Main menu: Access to the memory menu. File Explorer: Create a new file.
		Start the current function for the active file/directory.
		Change to the superordinate directory.
		Change to the currently marked directory.
		In the current directory scroll upwards.
		In the current directory scroll downwards.

### Define user directory (Define user directory)

Defines the standard directory in which the files are stored for further processing.



#### NOTICE!

An user directory is to be defined:

- before using and/or navigating through the memory menu.
- if formatting of CF card is effected at PC and thus the STANDARD directory was not created automatically.

```
File Explorer
A:\
[Drives]
-><STANDARD>
<DIR_1>
```

```
Context Menu
A:
->Set as user dir
Format
Copy
```



Access to the memory menu.



Call the File Explorer.



Select the directory.



Indication of all available functions.



Select function *Set as user dir*.



Confirm selection.



Return to the main menu.

At the next start of the memory menu the selected directory is displayed as user directory.

### Load layout

Loads a layout within a defined user directory. The function allows quick access to the desired layout as only layout files are displayed and directories hidden.

```
Load layout
A:\STANDARD
->File_name1.prn
File_name2.prn
File_name3.prn
File_name4.prn
```



Access to the memory menu.



Select layout.



Confirm selection.

The printer display shows automatically the window to insert the number of copies which are to print.



Select the number of layouts which are to be printed.



Start the print order.



#### NOTICE!

The directory can NOT be changed here. A change of directory MUST be made in the File Explorer with the function *Change directory*.

\* not available

## File Explorer

The File Explorer is the file manager of the printing system. The File Explorer provides the main functions for the user interface of memory menu.

In the user directory, press key **F** to access to the File Explorer.

Following functions are available:

- Change drive and/or directory
- Load file
- Save layout and/or configuration
- Delete file(s)
- Format CF card
- Copy file(s)

## Change directory

Specifies the standard directory in which the files are stored for further processing.

```
File Explorer
A:\
[Drives]
-><STANDARD>
<DIR_1>

File Explorer
A:\STANDARD\
-><..>
layout01
layout02
```



Access to the memory menu.



Call the File Explorer.



Select the directory.



Confirm selection.

The selected directory is now displayed.

## Load file

Loads a file. This can be a configuration saved before, a layout, etc.

```
Load file
A:\STANDARD\
<..>
->layout01
layout02
```



Access to the memory menu.



Call the File Explorer.



Select the file



The selected file is loaded.



## NOTICE!

If the selected file is a layout, then the number of copies to print can be entered immediately.

## Save layout

Saves the currently loaded layout under the selected name.

```
Save file
A:\STANDARD
->Save layout
Save config.
noname
```



Access to the memory menu.



Call the File Explorer.



Change to the menu *Save file*.



Select the function *Save layout*.







Confirm the selection.

If an USB keyboard is attached a new file name for *noname* can be assigned.

**Save configuration**

Saves the complete current device configuration under the selected name.

```
Save file
A:\STANDARD
-----
Save layout
→ Save config.
-----
config.cfg
```







-  Access to the memory menu.
-  File Explorer aufrufen.
-  Change to the menu *Save file*.
-  Select the function *Save configuration*.
-  Confirm the selection.

If an USB keyboard is attached a new file name for *config.cfg* can be assigned.

**Delete file**

Deletes one or more files and/or directories irrevocably. With the deletion of a directory both the contained files and the subdirectories are deleted.

```
File Explorer
A:\STANDARD\
-----
layout01 *
→ layout02 *
layout03
layout04
-----
Context menu
2 objects marked
-----
→ Delete
Copying
```

-  Access to the memory menu.
-  Call the File Explorer.
-  Select the file.
-  Mark the files which are to be deleted. The marked entries are listed with \*. Repeat this procedure until all desired files and/or directories are marked for deletion.
-  Change to the context menu.
-  Select the function *Delete*.
-  Confirm the selection.

**Format memory card**







Formats irrevocably the memory card.



**NOTICE!**

USB sticks cannot be formatted at the printer!

```
File Explorer
DRIVES
-----
→ A: 954Mb free
U: No media
-----
Context menu
A:\
-----
Set as user dir
→ Formatting
Copy
```

-  Access to the memory menu.
-  Call the File Explorer.
-  Select the drive which is to be formatted.
-  Change to the context menu.
-  Select the function *Formatting*.
-  Confirm the selection.

**Copy memory card**

```
File Explorer
A:\STANDARD\
layout01      *
→layout02    *
layout03
layout04

Context menu
2 objects marked
Delete
→Copying

Select Destination
DRIVES
→A: 954Mb free
```

Creates a duplicate of the original file and/or the original directory to make changes independently of the original.



Access to the memory menu.



Call the File Explorer.



Select the file.



Mark the files which are to be copied. The marked entries are listed with \*. Repeat this procedure until all desired files and/or directories are marked for copying.



Change to the context menu.

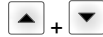

Select the function *Copying*.



Specify the target of the copying procedure.



Select the target storage.



Confirm the selection.

**Filter:****Possible with an attached USB keyboard only.**

For certain functions a filter mask or a file name of a file which is to be saved can be entered. This input is indicated in the path line. The filter mask can be used to search for specific files. For example, with the input of 'L' only the files are listed whose character string starts with 'L' (regardless of upper and lower cases).

**Without filter**

```
Load layout
A:\STANDARD
→First_file.prn
Layout_new.prn
Sample.prn
12807765.prn
```

**With filter**

```
Load layout
L
→Layout_new.prn
```

**Technical Data**

	Vita II 103/8 T	Vita II 104/8	Vita II 106/12	Vita II 106/24	Vita II 108/12 T
Print resolution	203 dpi	203 dpi	300 dpi	600 dpi	300 dpi
Max. print speed	200 mm/s	200 mm/s	150 mm/s	100 mm/s	150 mm/s
Print width	104 mm	104 mm	105.7 mm	105.7 mm	108.4 mm
Passage width					
Standard	116 mm	116 mm	116 mm	116 mm	116 mm
Cutter mode	112 mm	112 mm	112 mm	112 mm	112 mm
Printhead	Flat Type <sup>1</sup>	Flat Type <sup>2</sup>	Flat Type <sup>2</sup>	Flat Type <sup>2</sup>	Flat Type <sup>1</sup>
<b>Labels</b>					
Labels, continuous rolls or fan-fold	paper, cardboard, textile, synthetics				
Max. material weight	220 gr/m <sup>2</sup> (larger on demand)				
Min. label width	12 mm				
Min. label height					
Standard	5 mm				
Cutter/dispenser mode	15 mm				
Max. label height	6000 mm	6000 mm	3000 mm	1000 mm	3000 mm
Max. roll diameter					
Internal unwinder	180 mm				
Internal rewinder	---				
Core diameter	40 mm / 75 mm (option)				
Winding	outside or inside				
Label sensor	transmission or reflexion from bottom				
<b>Transfer Ribbon</b>					
Ink	outside or inside				
Max. roll diameter	Ø 80 mm				
Core diameter	25,4 mm / 1"				
Max. ribbon length	450 m				
Max. width	110 mm				
<b>Dimensions (mm)</b>					
Width x height x depth	236 x 238 x 374				
Weight	11 kg				
<b>Electronics</b>					
Processor	High Speed 32 Bit				
RAM	16 MB				
Slot	for Compact Flash card Type I				
Battery cache	for Real-Time clock (storage of data with shut-down)				
Warning signal	Acoustic signal when error				
<b>Interfaces</b>					
Serial	RS-232C (up to 115200 Baud)				
Parallel	SPP				
USB	2.0 High Speed Slave				
Ethernet	10/100 Base T, LPD, RawIP-Printing, DHCP, HTTP, FTP				
WLAN (option)	Module 802.11 b/g/n WEP, WPA, WPA-PSK, WPA2, WPA2-PSK, EAP				

<sup>1</sup> = Thermal direct<sup>2</sup> = Thermal transfer



<b>Operation Data</b>	<b>Vita II 103/8 T</b>	<b>Vita II 104/8</b>	<b>Vita II 106/12</b>	<b>Vita II 106/24</b>	<b>Vita II 108/12 T</b>
Power supply	110 ... 230 V AC / 50-60 Hz				
Power consumption	275 VA				
Nominal current	2.5 A				
Operating temperature	5 ... 35 °C				
Humidity	max. 80 % (non-condensing)				
<b>Operation Panel</b>					
Keys	Test print, function menu, quantity, CF Card, feed, enter, 4 x cursor				
LCD display	Graphic display 132 x 64 pixel				
<b>Settings</b>					
	Date, time, shift times 20 language settings (others on demand) Label and device parameters, interfaces, password protection, variables				
<b>Monitoring</b>					
Stop printing if	End of ribbon / end of labels / printhead open				
Status report	Extensive status print with information about settings e.g. print length counter, runtime counter, photocell interface and network parameters Printout of all internal fonts and all supported bar codes				
<b>Fonts</b>					
Font types	6 Bitmap fonts 8 Vector fonts/TrueType fonts 6 proportional fonts Other fonts on demand				
Character sets	Windows 1250 up to 1257, DOS 437, 850, 852, 857, UTF-8 All West and East European Latin, Cyrillic, Greek and Arabic (option) characters are supported. Other character sets on demand				
Bitmap fonts	Size in width and height 0,8 ... 5,6 Zoom 2 ... 9 Orientation 0°, 90°, 180°, 270°				
Vector fonts/TrueType fonts	Size in width and height 1 ... 99 mm Variable zoom Orientation 0°, 90°, 180°, 270°				
Font attributes	Depending on character font Bold, Italic, Inverse, Vertical				
Font width	Variable				
<b>Bar Codes</b>					
1D bar codes	CODABAR, Code 128, Code 2/5 interleaved, Code 39, Code 39 extended, Code 93, EAN 13, EAN 8, EAN ADD ON, GS1-128, Identcode, ITF 14, Leitcode, Pharmacode, PZN 7 Code, PZN 8 Code, UPC-A, UPC-E				
2D bar codes	Aztec Code, CODABLOCK F, DataMatrix, GS1 DataMatrix, MAXICODE, PDF 417, QR Code				
Composite bar codes	GS1 DataBar Expanded, GS1 DataBar Limited, GS1 DataBar Omnidirectional, GS1 DataBar Stacked, GS1 DataBar Stacked Omnidirectional, GS1 DataBar Truncated				
	All bar codes are variable in height, module width and ratio. Orientation 0°, 90°, 180°, 270° Optionally with check digit and human readable line.				
<b>Software</b>					
Configuration	ConfigTool				
Process control	NiceLabel				
Label software	Labelstar Office Lite, Labelstar Office				
Windows driver	Windows 7® - Windows 10® 32/64 Bit Windows Server 2008® (R2) - Windows Server 2019®				

Technical modifications are subject to change

## Cleaning



### DANGER!

Risk of death by electric shock!

⇒ Before opening the housing cover, disconnect the label printer from the mains supply and wait for a moment until the power supply unit has discharged.



### NOTICE!

When cleaning the label printer, personal protective equipment such as safety goggles and gloves are recommended.

Cleaning task	Frequency
General cleaning.	As necessary.
Clean the transfer ribbon drawing roller.	Each time the transfer ribbon is changed or when the printout is adversely affected.
Clean the pressure roller.	Each time the label roll is changed or when the printout and label transport are adversely affected.
Clean the printhead.	<p><b>Direct thermal printing:</b> Each time the label roll is changed.</p> <p><b>Thermal transfer printing:</b> Each time the transfer ribbon is changed or when the printout is adversely affected.</p>
Clean the label photocell.	When the label roll is changed.



### NOTICE!

The handling instructions for the use of Isopropanol (IPA) must be observed. In the case of skin or eye contact, immediately wash off the fluid thoroughly with running water. If the irritation persists, consult a doctor. Ensure good ventilation.



### WARNING!

Risk of fire by easily inflammable label soluble!

⇒ When using label soluble, dust must be completely removed from the label printer and cleaned.

## General Cleaning



### CAUTION!

Abrasive cleaning agents can damage the label printer!

⇒ Do not use abrasives or solvents to clean the outer surface of the label printer.

⇒ Remove dust and paper fuzz in the printing area with a soft brush or vacuum cleaner.

⇒ Clean the outer surfaces with an all-purpose cleaner.

## Clean the Transfer Ribbon Drawing Roller

A soiled drawing roller can lead to a reduced print quality and can affect the transport of material.

- Remove the printer cover.
- Remove transfer ribbon from the label printer.
- Remove deposits with the roller cleaner and a soft cloth.
- If the roller appears damaged, replace it.

## Clean the Pressure Roller

A soiled pressure roller can lead to a reduced print quality and can affect the transport of material.



### CAUTION!

Pressure roller can be damaged!

⇒ Do not use sharp or hard objects to clean the pressure roller.

- Turn the lever counter clockwise to lift up the printhead.
- Remove labels and transfer ribbon from the label printer.
- Remove deposits with the roller cleaner and a soft cloth.
- If the roller appears damaged, replace it.

## Clean the Printhead

Printing can cause accumulation of dirt at the printhead e.g. by colour particles of the transfer ribbon, and therefore it is necessary to clean the printhead in regular periods depending on operating hours, environmental effects such as dust etc.



### CAUTION!

Printhead can be damaged!

⇒ Do not use sharp or hard objects to clean the printhead.

⇒ Do not touch the protective glass layer of the printhead.

- Turn the lever counter clockwise to lift up the printhead.
- Remove labels and transfer ribbon from the label printer.
- Clean the printhead surface with a special cleaning pen or a cotton swab dipped in pure alcohol.
- Before using the label printer, let the printhead dry for about two to three minutes.

## Clean the Label Photocell



### CAUTION!

Label photocell can be damaged!

⇒ Do not use sharp or hard objects or solvents to clean the label photocell.

The label photocell can be soiled with paper dust. This may affect the label scanning.

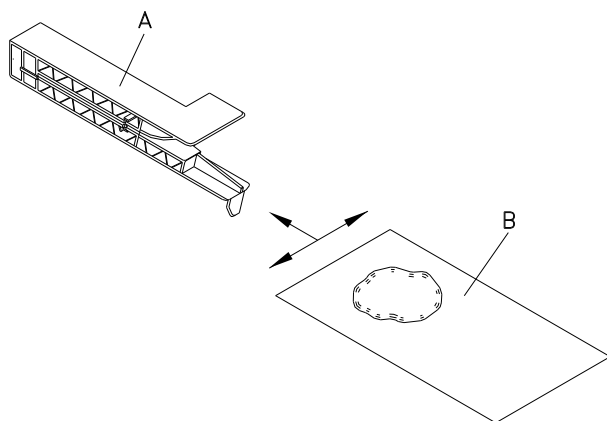

- Turn the lever counter clockwise to lift up the printhead.
- Remove labels and transfer ribbon from the label printer.
- Blow out the photocell (A) with the compressed air spray. You have strictly to observe the instructions mentioned on the can.
- Moisten a cleaning card (B) with printhead and roll solvent to clean additionally the photocell inside.
- Reload labels and transfer ribbon.



Guida rapida e sicurezza  
del prodotto

Italiano

Copyright by Carl Valentin GmbH

Le indicazioni in merito di fornitura, all'aspetto, alla prestazione, alle dimensioni e al peso rispecchiano le nostre conoscenze al momento della pubblicazione.

Conforme a cambiamento.

Tutti i diritti, compresi quelli della traduzione, riservati.

È vietata la riproduzione, l'elaborazione mediante l'utilizzo di sistemi elettronici o la diffusione in qualsiasi forma (stampa, fotocopia o altro tipo di procedimento) di qualsiasi parte del presente manuale senza l'autorizzazione scritta di Carl Valentin GmbH.

Con il costante sviluppo delle apparecchiature possono verificarsi differenze tra la documentazione e l'apparecchio. L'edizione attuale si trova alla pagina [www.carl-valentin.de](http://www.carl-valentin.de).

### **Marchi**

Tutti i marchi o marchi di fabbrica citati sono marchi registrati o marchi di fabbrica registrati dei rispettivi proprietari e possono eventualmente non recare indicazioni a parte. Dalla mancanza d'indicazioni a parte non può essere dedotto che non si tratti di un marchio registrato o di un marchio di fabbrica registrato.

La stampante per etichette Carl Valentin soddisfano le seguenti direttive sulla sicurezza:

- CE**     Direttiva sulla bassa tensione (2014/35/UE)
- Direttiva sulla compatibilità elettromagnetica (2014/30/UE)



### **Carl Valentin GmbH**

Postfach 3744  
78026 Villingen-Schwenningen  
Neckarstraße 78 – 86 u. 94  
78056 Villingen-Schwenningen

Phone     +49 7720 9712-0  
Fax        +49 7720 9712-9901

E-Mail     info@carl-valentin.de  
Internet   www.carl-valentin.de

---

## Contenuto

Uso conforme	120
Indicazioni di sicurezza	120
Smaltimento ecologico	120
Condizioni d'esercizio	121
Spacchettare la stampante	124
Perimetro di consegna	124
Installazione della stampante	124
Allacciamento della stampante	124
Messa in funzione della stampante	124
Inserire etichette nella modalità di straccio	125
Inserire nastro di trasferimento	126
Print Settings (Inizializzazione della stampa)	127
Label Layout (Layout di etichetta)	127
Device Settings (Parametri dell'apparecchio)	128
Network (Rete)	130
Password (Passwort)	130
Interfacce (Interfacce)	131
Emulation (Emulazione)	131
Date & Time (Data & Ora)	132
Service Functions (Funzioni d'assistenza)	133
Main Menu (Menu principale)	135
Scheda Compact Flash	136
Dati tecnici	140
Pulizia del rullo di trazione del nastro	142
Pulizia del rullo pressore	143
Pulizia della testina di stampa	143
Pulizia della fotocellula delle etichette	143

## Uso conforme

- La stampante di etichette è costruita secondo lo stato della tecnica e in osservanza delle regole sulla sicurezza tecnica. Ciononostante, durante il suo impiego possono risultare pericoli per l'incolumità dell'utente o di terzi, nonché danneggiamenti alla stampante e ad altri oggetti di valore.
- La stampante di etichette può essere utilizzata solo se in condizioni tecnicamente perfette, in conformità con la normativa vigente e con consapevolezza dei requisiti di sicurezza e dei pericoli in osservanza delle istruzioni per l'uso! In particolare i guasti che possono comprometterne la sicurezza devono essere eliminati immediatamente.
- La stampante di etichette è destinata esclusivamente alla stampa di materiali adeguati il cui uso è autorizzato dal produttore. Un uso diverso più ampio non è regolamentare. Il produttore/fornitore non risponde di danni risultanti da un utilizzo improprio, il rischio è solo dell'utente.
- Dell'uso regolamentare fa parte anche l'osservanza delle istruzioni per l'uso, incluse le raccomandazioni/prescrizioni del produttore in merito alla manutenzione.

## Indicazioni di sicurezza

- La stampante di etichette è concepita per reti elettriche con tensione alternata di 110 ... 230 V AC. Collegare la stampante di etichette solo a prese con contatto per conduttore di protezione.
- Collegare la stampante di etichette solo ad apparecchiature con tensione inferiore.
- Prima di stabilire o staccare collegamenti, spegnere tutte le apparecchiature interessate (computer, stampante, accessori).
- Utilizzare la stampante solo in un ambiente asciutto e non esporla ad acqua (spruzzi d'acqua, nebbia ecc.).
- Gli interventi di manutenzione e riparazione possono essere effettuati solo da personale specializzato addestrato.
- Gli operatori devono essere istruiti dal gestore in base alle istruzioni per l'uso.
- Se la stampante è utilizzata con il coperchio aperto, accertarsi che capelli, gioielli o simili con centrino in contatto con le parti rotanti esposte.
- Il modulo o parti di essi come (testina di stampa) mentre stampa si possono riscaldare. Non toccare il modulo durante il funzionamento, lasciarlo raffreddare prima di cambiare pezzi o fare delle regolazioni.
- Non utilizzare mai materiale di consumo facilmente infiammabile.
- Pericolo di ferimento al bordo staccabile. Nel caso che non si usa il bordo, applicare il paraspigolo.
- Effettuare solo quanto descritto nelle presenti istruzioni per l'uso. Attività diverse possono essere eseguite solo dietro esplicito consenso del produttore.
- Un intervento scorretto sui gruppi elettronici e i relativi software può provocare dei guasti.
- Lavori o modifiche scorretti dell'apparecchio possono pregiudicarne la sicurezza di funzionamento.
- Far sempre eseguire gli interventi di manutenzione dal personale di un'officina qualificata in possesso delle conoscenze specialistiche e dell'attrezzatura necessarie nel caso specifico.
- Sugli apparecchi sono apposti diversi avvertimenti che indicano i pericoli potenziali. Non rimuovere questi adesivi. In caso contrario, sarà impossibile identificare i pericoli.



### **PERICOLO!**

Pericolo di morte dovuto alla tensione di rete!

⇒ Non aprire il alloggiamento della stampante.

## Smaltimento ecologico

Dal 23.03.2006, i fabbricanti di apparecchi B2B sono tenuti a riprendere e riciclare gli apparecchi usati prodotti dopo il 13.08.2005. In principio, questi apparecchi usati non possono essere smaltiti presso i centri di raccolta comunali. Essi devono essere riciclati ed eliminati soltanto dai fabbricanti ed in maniera strutturata. Questo tipo di prodotto marchiato Valentin potrà pertanto essere rinviato a Carl Valentin GmbH.

Gli apparecchi usati saranno allora smaltiti a regola d'arte.

Carl Valentin GmbH osserva così tutti i doveri nell'ambito dello smaltimento degli apparecchi usati permettendo inoltre la distribuzione agiata dei prodotti. Possiamo riprendere soltanto apparecchi inviati franco di porto.

La scheda elettronica del sistema di stampa è dotato di una batteria al litio. Questa deve essere smaltita in contenitori di raccolta per batterie esauste presenti presso i rivenditori o le aziende municipalizzate.

Più informazioni rilevabili dalla direttiva WEEE o sul nostro sito [www.carl-valentin.de](http://www.carl-valentin.de)



## Condizioni d'esercizio

Le condizioni di funzionamento rappresentano i presupposti da rispettare prima della messa in funzione e durante il funzionamento dei nostri apparecchi, al fine di ottenere un funzionamento sicuro e privo di guasti.

Leggere attentamente le condizioni di funzionamento.

In caso di dubbi circa la messa in pratica delle condizioni di funzionamento, rivolgersi a noi o al servizio di assistenza ai clienti.

## Condizioni generali

Fino al momento dell'installazione gli apparecchi devono essere trasportati e conservati nell'imballaggio originario.

Prima di aver rispettato le condizioni di funzionamento gli apparecchi non devono essere installati e non devono essere messi in funzione.

È possibile procedere alla messa in funzione, alla programmazione, all'utilizzo, alla pulizia ed alla cura dei nostri apparecchi solo dopo aver letto le istruzioni.

Gli apparecchi devono essere utilizzati esclusivamente da personale addestrato.



### AVVISO!

Si raccomandano training regolari.

I contenuti dei training sono al capitolo 'Condizioni d'esercizio', 'Inserimento del materiale' e capitolo 'Pulizia e manutenzione'.

Le note valgono anche per le apparecchiature esterne da noi fornite.

È necessario utilizzare esclusivamente i pezzi di ricambio originali.

Per i ricambi e i pezzi soggetti ad usura, rivolgersi al produttore.

## Condizioni in sede d'installazione

Installare le stampanti su una superficie piana e priva di vibrazioni. Evitare correnti d'aria.

Le stampanti devono essere installate in modo tale da garantire un funzionamento ottimo.

## Installazione dell'alimentazione

L'installazione dell'alimentazione per il collegamento delle nostre stampanti, deve essere effettuata nel rispetto alle norme e disposizioni internazionali:

- International Electronic Commission IEC
- CENELEC European Committee for Electrotechnical Standardization
- VDE Verband Deutscher Elektrotechniker

Le nostre stampanti sono costruite a norma VDE e devono essere collegate ad un conduttore collegato a massa per eliminare tensioni di disturbo interne. L'alimentatore deve essere dotato di un conduttore di terra.

## Dati tecnici dell'alimentazione

Tensione e frequenza della linea d'alimentazione:	vedi targhetta
Tolleranza dell'alimentazione dalla rete consentita:	+6 % ... -10 % dal valore nominale
Tolleranza della frequenza di rete consentita:	+2 % ... -2 % dal valore nominale
Fattore di distorsione dell'alimentazione dalla rete consentito:	≤ 5 %

### Misure contro le interferenze:

Alla presenza di una rete "disturbata" (ad esempio per l'uso di macchine controllate ad inverte) è necessario adottare specifiche misure contro le interferenze, ad esempio:

- Prevedere un'alimentazione separata per le nostre stampanti.
- Adottare un trasformatore d'isolamento a capacità disaccoppiata o analogo soppressore d'interferenze davanti alle nostre stampanti.

## Radiazione parassita e immunità di disturbi

Interferenze/Emissione secondo EN 61000-6-3: 2007 settore d'industria.

- Tensione parassita sulle linee secondo EN 55022: 09-2003.
- Intensità campo di interferenza secondo EN 55022: 09-2003.
- Correnti armoniche (reazione rete) secondo EN 61000-3-2: 09-2006
- Flicker secondo EN 61000-3-3: 1955 + A1:2001 + A2:2005

Resistenza all'interferenza/Immunità secondo EN 61000-6-2: 2005 settore d'industria.

- Immunità dalle scariche di elettricità statica ai sensi della EN 61000-4-2: 12-2001
- Campi magnetici ai sensi della EN 61000-4-3: 11-2003, ENV 50204: 03-1995
- Immunità dalle grandezze perturbatrici transitori rapidi (Burst) ai sensi della EN 61000-4-4: 07-2005
- Immunità dalle tensioni impulsive (Surge) ai sensi della EN 61000-4-5: 12-2001
- Frequenze alte ai sensi della EN 61000-4-6: 12-2001
- Interruzione di tensione e abbassamento di tensione ai sensi della EN 61000-4-11: 02-2005



### AVVISO!

Questo è un dispositivo di classe A. In ambiente domestico potrebbe provocare effetti di radiodisturbi. In questo caso il gestore è obbligato di attuare misure idonee.

## Collegamento delle linee a macchine esterne

Tutte le linee di collegamento devono essere schermate. La schermatura deve essere collegata su entrambi i lati alla guaina del connettore.

Non è ammesso cablare le linee parallelamente alle linee d'alimentazione. Se ciò dovesse essere inevitabile, mantenere una distanza di almeno 0,5 m.

Temperature tra le linee: -15 ... +80 °C.

Si possono collegare solamente apparecchi che corrispondono alle norme di 'Safety Extra Low Voltage' (SELV). In generale questi apparecchi sono controllati secondo la norma EN 60950/EN 62368-1.

## Installazione delle linee dati

I cavi di dati devono essere schermati e dotati di connettori custoditi di metallo oppure metallizzati. Questo tipo di cavi schermati, servono per evitare disturbi elettrici.

Linee ammesse

Linea schermata:        4 x 2 x 0,14 mm<sup>2</sup> ( 4 x 2 x AWG 26)  
                              6 x 2 x 0,14 mm<sup>2</sup> ( 6 x 2 x AWG 26)  
                              12 x 2 x 0,14 mm<sup>2</sup> (12 x 2 x AWG 26)

Il cavo per la linea di trasmissione e ricezione deve essere a coppia intrecciata.

Massima lunghezza delle linee:        Interfaccia V 24 (RS232C) - 3 m (linea schermata)  
    Interfaccia parallela - 3 m (linea schermata)  
    USB - 3 m  
    Ethernet - 100 m

## Ventilazione

Per evitare surriscaldamenti garantire un libero convogliamento dell'aria.

## Valori limite

Tipo di protezione secondo IP:	20
Temperatura ambiente °C (esercizio):	Min. +5 Max. +35
Temperatura ambiente °C (magazzinaggio):	Min. -20 Max. +60
Umidità relativa % (esercizio):	Max. 80
Umidità relativa % (magazzinaggio):	Max. 80 (non è consentito bagnare gli apparecchi)

## Garanzia

Respingiamo qualsiasi responsabilità per danni prodotti da:

- Mancato rispetto delle nostre condizioni d'esercizio e del manuale operativo.
- Installazione elettrica errata.
- Alternazioni strutturali delle nostre stampanti.
- Errata programmazione delle nostre stampanti.
- Mancata protezione dei dati.
- Utilizzo di ricambi e accessori non originale Valentin.
- Usura e logorio naturali.

In occasione della (re)installazione o programmazione delle nostre stampanti controllare la nuova impostazione con un avvio e stampa di prova. Sarà così possibile evitare risultati, rapporti e valutazioni errate.

Le stampanti dovranno essere utilizzate esclusivamente da personale addestrato.

Controllare l'utilizzo corretto dei nostri prodotti e ripetere il training.

Non assumiamo nessuna garanzia, che tutti i modelli contengono tutte le caratteristiche descritte in questo manuale. Essendo interessati a sviluppare tecnologie nuove e miglioramenti, è possibile che i dati tecnici possono essere cambiati senza nessun preavviso.

A seguito di nuovi sviluppi o norme nazionali, le illustrazioni e gli esempi descritti nei manuali potrebbero differire dal modello fornito.

Si prega di seguire le istruzioni riferite ai materiali di stampa e le indicazioni sulla pulizia della stampante, per evitare danneggiamenti o usura anticipata.

Abbiamo cercato di scrivere questo manuale in modo comprensibile, per darvi il massimo delle informazioni. In caso di dubbi o se scoprite degli errori, vi preghiamo di darcene comunicazione al fine di poter perfezionare i nostri manuali e offrirvi un servizio migliore.

## Spacchettare la stampante

- ⇒ Sollevare la stampante sul fondo del dispositivo ed estrarla dall'imballaggio.
- ⇒ Verificare che la stampante non si sia danneggiata durante il trasporto.
- ⇒ Verificare la presenza di tutte le parti.

## Perimetro di consegna

- Stampante di etichette.
- Anima del nastro vuota, montata sull'avvolgitore del nastro transfer.
- Bordo staccabile.
- Bordo distributivo (solo apparecchiature con opzione distributore).
- Cavo principale.
- Documentazione.
- CD con driver della stampante.
- Labelstar Office LITE.



### AVVISO!

Conservare l'imballo originale, per poterlo riutilizzare in seguito qualora si renda necessario trasportare l'apparecchio.

## Installazione della stampante



### ATTENZIONE!

Danneggiamento dell'apparecchiatura e dei materiali di stampa tramite umidità.

- ⇒ Installare la stampante di etichette solo in luoghi asciutti protetti da spruzzi d'acqua.
- ⇒ Collocare la stampante su una base piana.
- ⇒ Aprire il coperchio della stampante.
- ⇒ Rimuovere il materiale espanso utilizzato come protezione per il trasporto dall'area della testina di stampa.

## Allacciamento della stampante

La stampante è dotata di un alimentatore ad ampia tensione. È dunque possibile utilizzare sia una tensione di rete di 110 ... 230 V AC / 50-60 Hz senza apportare modifiche all'apparecchiatura.



### ATTENZIONE!

Danneggiamento dell'apparecchio dovuto a correnti di transitorio non definite.

- ⇒ Prima di effettuare l'allacciamento alla rete, portare l'interruttore di rete nella posizione '0'.
- ⇒ Inserire il cavo di rete nella presa .
- ⇒ Inserire la spina del cavo di rete nella presa collegata a terra.



### AVVISO!

Sono possibili disturbi di funzionamento a causa di un collegamento a terra insufficiente o del tutto assente. Accertarsi che tutti i computer collegati alla stampante di etichette e i cavi di collegamento siano collegati a terra.

- ⇒ Collegare la stampante al computer o alla rete con un cavo adatto.

## Messa in funzione della stampante

Una volta stabiliti tutti i collegamenti:

- ⇒ Accendere la stampante dall'interruttore di rete. All'accensione della stampante compare sul display il menu base che visualizza il tipo della stampante, l'ora e la data attuale.
- ⇒ Inserire il materiale per le etichette e il nastro di trasferimento.
- ⇒ Avviare misurazione nel menu *Layout di etichetta/Misura etichetta*.
- ⇒ Con il tasto  sulla tastiera è possibile interrompere la misurazione.



### AVVISO!

Per ottenere una misurazione corretta, devono essere avanzate minime due etichette. Questa premessa non vale, in caso di stampa d'etichette a modo continuo.

È possibile che siano rilevate lievi differenze alla misurazione della lunghezza e dello spazio. È possibile impostare a mano i valori per la lunghezza dell'etichetta e lo spazio, nel menu *Layout di etichetta/Etichetta e Taglio*.

## Inserire etichette nella modalità di straccio

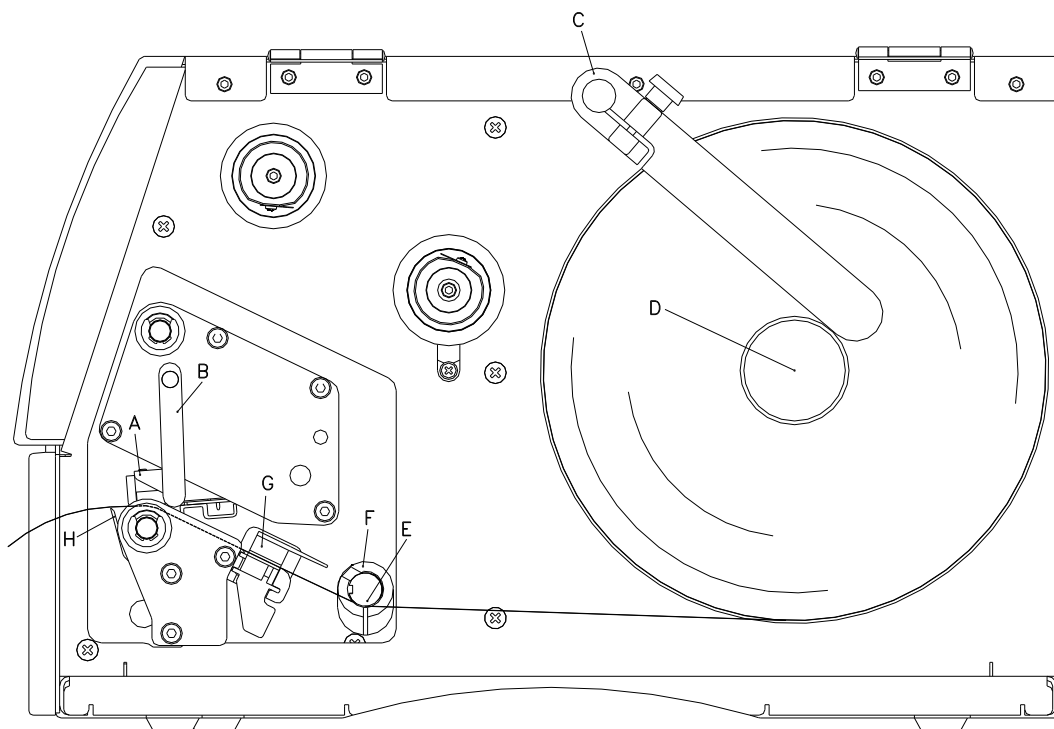

- Aprire il coperchio della stampante.
- Alzare la testina di stampa (G), ruotando in senso antiorario la leva a pressione rossa (F).
- Rimuovere il supporto esterno delle etichette (A).
- Collocare il rotolo d'etichette con avvolgimento interno sulla svolgitrice (B) e riposizionare il supporto delle etichette (A).
- Inserire il materiale per etichette sotto l'albero di rinvio (C) e la testina di stampa (G). Accertarsi che il materiale passa attraverso la fotocellula (E).
- Abbassare la testina di stampa (A), ruotando in senso orario la leva a pressione rossa (B) fino all'arresto in posizione.
- Davanti alla testina di stampa è visibile il bordo di separazione (H).
- Nella voce del menu *Inizializzazione/Bordo staccabile*, inserire il valore Offset.
- Impostare l'anello di regolazione (D) dell'albero di rinvio in base alla larghezza del materiale.
- Chiudere il coperchio della stampante.

## Inserire nastro di trasferimento



### AVVISO!

Per la stampa a trasferimento termico è necessario inserire un nastro di trasferimento. Stampando nel modo termo diretto, non si deve inserire un nastro. La larghezza del nastro deve corrispondere a quella del medio da stampare. Nel caso che il nastro è più stretto, la testina parzialmente non ha nessuna protezione e così si rompe prima.

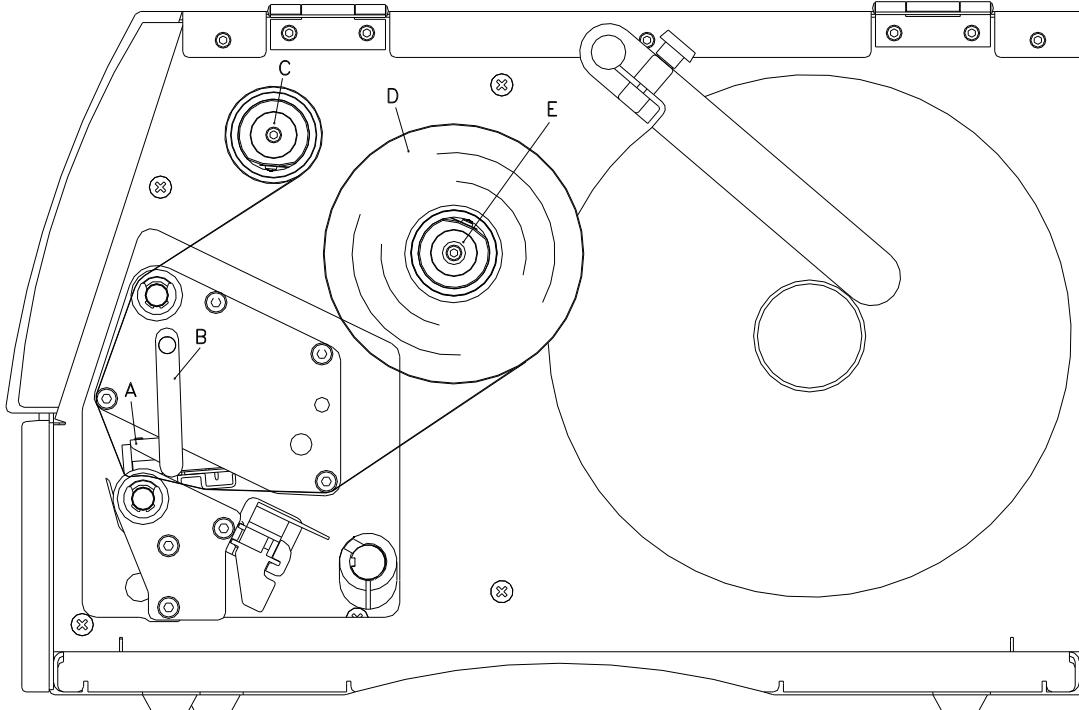

### AVVISO!

Consigliamo di pulire la testina di stampa con un detersivo speciale (97.20.002), prima di inserire un nastro di trasferimento nuovo. Devono essere osservate le norme per l'uso di isopropanolo (IPA). In caso di contatto con la pelle o con gli occhi, risciacquare bene con acqua corrente. In caso di irritazione persistente, contattare un medico. Assicurarsi che vi sia una aerazione sufficiente.

- Prima di inserire il nastro transfer, pulire la testina di stampa.
- Aprire il coperchio della stampante.
- Alzare la testina di stampa (E), ruotando in senso antiorario la leva a pressione rossa (D).



### ATTENZIONE!

Pericolo di abrasioni durante l'inserimento del nastro di trasferimento e/o l'estrazione del nastro di trasferimento consumato!

⇒ Prestare attenzione ai bordi del piatto della molla!

- Inserire il rotolo del nastro di trasferimento (con avvolgimento esterno) (B) arrotolandolo sulla bobina svolgitrice (C).
- Posizionare un rocchetto vuoto sull'avvolgitore (A) e far passare il nastro di trasferimento sotto la testina di stampa (E).
- Fissare il nastro di trasferimento, con un nastro adesivo, al rocchetto vuoto (in direzione di cammino) sulla bobina dell'avvolgitore (A). Verificare che il nastro di trasferimento venga avvolto in senso antiorario.
- Abbassare la testina di stampa (E), ruotando in senso orario la leva a pressione rossa (D) fino all'arresto in posizione.
- Chiudere il coperchio della stampante.



### AVVISO!

È necessario considerare l'uso di nastri antistatici. Le cariche elettrostatiche possono danneggiare la testina di stampa (il rivestimento della testina di stampa) o altri elementi elettronici. L'utilizzo di materiali non adatti causa funzionamenti erronei e può far scadere la garanzia.



### ATTENZIONE!

Influsso di materiale statico sull'uomo!

⇒ Utilizzare un nastro di trasferimento antistatico, poiché in occasione della rimozione potrebbe verificarsi una scarica elettrostatica.

## Print Settings (Inizializzazione)

Sequenza di tasti: **F**, 

### Speed (Velocità)

Indica la velocità in mm/s.  
Valori impostabili: 50 mm/s ... 200 mm/s (vedi dati tecnici).

### Contrast (Forza d'accensione)

Indica l'intensità di stampa quando si usa materiali di stampa diversi, varie velocità oppure testi diversi.  
Valori impostabili: 10 % ... 200 %.

Tasto: 

### Transfer ribbon control (Controllo del nastro di trasferimento)

Viene controllato se il nastro di trasferimento è finito o strappato.  
**Off:** Il controllo del nastro di trasferimento non è attivo.  
**On, weak sensibility (sensibilità debole):** Il controllo del nastro di trasferimento è attivo. La stampante reagisce di ca. 1/3 più lentamente alla fine del nastro di trasferimento (default).  
**On, strong sensibility (sensibilità forte):** Il controllo del nastro di trasferimento è attivo. La stampante reagisce immediatamente, alla fine del nastro di trasferimento.

Tasto: 

### Y displacement (Spostamento Y)

Indica lo spostamento del punto d'origine, espresso in mm.  
Valori impostabili: -30.0 ... +90.0.

Tasto: 

### X displacement (Spostamento X)

Spostamento dell'intera immagine di stampa trasversalmente alla direzione di avanzamento della carta.  
Valori impostabili: -90.0 ... +90.0.

Tasto: 

### Tear-off offset (Bordo staccabile)

Indica il valore dell'avanzamento dell'ultima etichetta stampata. Al termine di un ordine di stampa, l'ultima etichetta viene portata automaticamente in avanti del valore impostato.  
Valori impostabili: 0 ... 50.0 mm.  
Valore standard: 12 mm.

## Label Layout (Layout di etichetta)

Sequenza di tasti: **F**, , 

### Label length (Lunghezza etichetta)

Indica la lunghezza dell'etichetta in mm  
Altezza minima: 5 mm (distributore 25 mm)

### Gap length (Lunghezza taglio)

Indica la distanza tra due etichette in mm  
Valore minimo: 1 mm

Tasto: 

### Column printing (Stampa a colonne)

Indica la larghezza dell'etichetta e il numero delle etichette, che si trovano una vicina all'altra.

Tasto: 

### Measure label (Misura etichetta)

Premere il tasto  per avviare la misurazione.

Tasto: 

### Label type (Tipo etichette)

L'impostazione standard prevede etichette adesive. Per selezionare etichette in continuo usare il tasto .

Tasto: 

### Material selection (Scegliere materiale)

Scelta per materiale d'etichetta e nastro di trasferimento.

Tasto: 

### Photocell (Fotocellula)

Scelta della fotocellula.  
Sono disponibili i seguenti tipi: Luce passante normale, riflessione normale, luce passante inversa, riflessione inversa, fotocellula a ultrasuoni (opzione).

### Scan position - SP (Posizione di scansione - PE)

Con l'aiuto di questa funzione è possibile inserire la lunghezza dell'etichetta, in percento. È possibile saltare marcature sull'etichetta.

Tasto: **Label error length  
(Errore etichetta-  
lunghezza)**

Imposta dopo quanti mm, la stampante si arresta (in caso d'errore) visualizzando il messaggio d'errore sul display.  
Valori impostabili: 1 mm ... 999 mm.

**Synchronization  
(Sincronizzare)**

**On:** In caso di mancanza dell'etichetta un messaggio d'errore viene visualizzato sul display.  
**Off:** La mancanza dell'etichetta viene ignorata.

Tasto: **Flip label  
(Specchiare etichetta)**

L'asse specchio si trova al centro dell'etichetta. Se la larghezza dell'etichetta non è stata trasmessa alla stampante, si applica la larghezza etichetta default, vale a dire la larghezza della testina di stampa. Per evitare problemi di posizionamento è necessario che la larghezza dell'etichetta corrisponde a quella della testina.

Tasto: **Rotate label  
(Rotazione etichetta)**

La stampa standard, stampa le etichette con testa in avanti e senza girarla 0°. Attivando questa funzione l'etichetta sarà girata di 180 in direzione di lettura.

Tasto: **Rotate label in degrees  
(Rotazione etichetta en °)**

Secondo il parametro *Rotazione etichetta* è possibile ruotare l'etichetta a step di 90°.

**AVVISO!**

Si possono ruotare solo oggetti interni alla stampante (testi, linee e codici a barre).  
La rotazione di grafici è impossibile.

Tasto: **Alignment  
(Regolazione)**

Il posizionamento dell'etichetta avviene soltanto dopo la rotazione/specchiatura, vale a dire che il posizionamento è indipendente.

**Left (Sinistra):** La posizione dell'etichetta è sul bordo destro della testina di stampa.

**Centre (Centro):** La posizione dell'etichetta è al centro della testina di stampa.

**Right (Destra):** La posizione dell'etichetta è sul bordo destro della testina di stampa.

**Device Settings (Parametri dell'apparecchio)**Sequenza di tasti:  , , **Field handling  
(Gestione campo)**

**Off:** L'intera memoria della stampante viene cancellata.

**Keep graphic (Salvare grafica):** Quando un'immagine grafica o un True Type viene trasmesso per la prima volta alla stampante, la stampante memorizza automaticamente questi dati (nella memoria interna), per poterli riutilizzarli. Per i lavori successivi, vengono trasmessi solamente i dati modificati alla stampante, con il vantaggio di un notevole risparmio di tempo nella trasmissione dei dati grafici.

L'immagine dati creati dalla stampante (caratteri interni e/o codici a barre) vengano generati soltanto se sono modificati. Viene così risparmiato tempo anche nella generazione della stampa.

**Delete graphic (Cancellare grafica):** Le grafiche e i font True Type archiviati nella memoria interna della stampante vengono eliminati, ma i campi relativi rimangono in memoria.

**Restore graphic (Ripristinare grafica):** Al termine di un incarico di stampa, è possibile riavviare l'incarico stampato sulla stampante. Tutti i grafici e i caratteri TrueType vengono stampati nuovamente.

**AVVISO!**

**Eccezione:** In caso di stampa a colonne è sempre necessario stampare colonne intere (il numero di esemplari deve essere sempre un multiplo delle colonne). Le colonne cancellate non verranno ripristinate.

Tasto: **Codepage  
(Codepage)**

Scelta per il set di caratteri da utilizzare. C'è la possibilità di scegliere tra i set successivi: Codepage 437, Codepage 850, Codepage 852, Codepage 857, Codepage 1250, Codepage 1251, Codepage 1252, Codepage 1253, Codepage 1254, Codepage 1257, WGL4.  
La tabella per i set di caratteri riportati qui sopra è contenuta nel sito internet.

Tasto: **External parameters  
(Parametri esterni)**

**Label dimension only (Solo misure dell'etichetta):** I parametri della lunghezza, larghezza e spazio tra una etichetta e l'altra possono essere inviati. Tutti gli altri parametri devono essere effettuati alla stampante direttamente.

**On:** Con il nostro software per la creazione d'etichette è possibile trasmettere i parametri, velocità e intensità di stampa alla stampante. Parametri impostati direttamente sulla stampante non vengono tenuti in considerazione.

**Off:** Vengono considerati esclusivamente i valori impostati direttamente sulla stampante (i valori trasmessi non vengono tenuti in considerazione).



Tasto: **Cicalino (buzzer)****On:** Abilita il segnale acustico (bip) premendo ad ogni tasto.

Valori impostabili: 1 ... 7.

**Off:** Disabilita il segnale acustico (bip).**Display  
(Display)**

Regolazione del contrasto del display.

Valori impostabili: 45 ... 75.

Tasto: **Language  
(Lingua)**

Selezione della lingua in cui dovrà essere visualizzato il testo sul display della stampante.



Attuale è possibile scegliere tra le lingue tedesco, inglese, francese, spagnolo, finlandese, ceco, portoghese, olandese, italiano, danese, polacco, greco, ungherese, russo, cinese (opzione), ucraino, turco, svedese, norvegese, estone.

Tasto: **Keyboard  
(Configurazione tastiera)**

Si può scegliere la configurazione della tastiera tra le seguenti nazione: Germania, Inghilterra, Francia, Grecia, Spagna, Svezia, US e Russia.

Tasto: **Customized entry  
(Inserimento utente)****Off:** Sul display non appare l'interrogazione, per la variabile della guida utente. In questo caso sarà stampato il valore standard impostato.**On:** L'interrogazione per la variabile guidata dall'utente, sarà visualizzata solo una volta sul display (centralina elettronica). Questo accade prima che l'ordine di stampa si avvia.**Auto (automatico):** Le interrogazioni per la variabile guidata dall'utente e per la quantità appaiono dopo ogni layout.**Auto without quantity query (automatico senza interrogazione della quantità):**



L'interrogazione per la variabile guidata dall'utente appare dopo ogni layout senza interrogazione supplementare per la quantità.

Tasto: **Hotstart  
(Avvio a caldo)****On:** Dopo la riaccensione della stampante, un ordine interrotto può essere riavviato.**Off:** Quando la stampante viene spenta, tutti i dati vanno persi.Tasto: **Autoload  
(Autoload)****Attivato:** Un'etichetta scaricata dalla Compact Flash Card una volta può essere ricaricata automaticamente dopo il riavvio della stampante.

Dopo il riavvio della stampante, l'etichetta ricaricata è sempre l'ultima scaricata dalla CF Card.



**Disattivato:** Dopo un riavvio della stampante, è necessario ricaricare manualmente l'ultima etichetta utilizzata dalla CF Card.

Un uso comune delle funzioni Autoload e avvio a caldo no è possibile.

Tasto: **Manual reprint  
(Ristampa manuale)****Yes (Si):** Nel caso che la stampante si trova nello stato interrotto p.e. per causa di errore, con i tasti  e  si può ristampare l'ultima etichetta stampata.**No (No):** Avanza solamente etichette vuote.Tasto: **Backfeed/Delay  
(Ritiro/ritardo)****Backfeed (Ritiro):** Il ritiro dei modi d'uso, elencati in seguito, è stato ottimizzato.

Modo d'uso: Distributore (opzione) e taglierina (opzione). La stampante 'inizia a stampare' (se possibile) l'etichetta seguente, durante il ritiro nell'offset. Non occorre ritirare l'etichetta e così si ottiene un risparmio di tempo.

**Delay (Ritardo):** Impostare il tempo di ritardo, fa solamente senso se si lavora con il modo d'uso *Ritiro automatico*.Tasto: **Confirm label change  
(Conferma eticheta)****On (attivato):** Un nuovo job di stampa viene stampato soltanto dopo la conferma sull'apparecchio. La stampa di un job di stampa continua già attivo prosegue finchè non avviene la conferma sull'apparecchio.**Off (disattivato):** Nessun'interrogazione compare sul display del comando.Tasto: **Standard label  
(Etichetta standard)****On (attivato):** Se si avvia un job di stampa senza previa definizione dell'etichetta, l'etichetta stampata sarà standard (tipo di apparecchio, versione firmware, versione build).**Off (disattivato):** Se si avvia un job di stampa senza previa definizione dell'etichetta, un messaggio di errore compare sullo schermo.

Tasto: **Synchronization at switching on (Sincronizzare all'accensione)****Off:** La sincronizzazione è disattivata, questo vuol dire che la misurazione e l'avanzamento dell'etichetta dovrà essere attivato a mano.**Measure (Misurare):** Subito dopo l'accensione della stampante, l'etichetta sarà misurata automaticamente.**Label feed (Avanzamento di etichette):** Dopo aver acceso la stampante, l'etichetta è sincronizzata all'inizio delle etichette. Per questo, vengono spostate in avanti una o più etichetteTasto: **CMI length (Lunghezza CMI)**

Se la stampa viene interrotta in etichetta, alla testina di stampa si può avere una piccola interruzione dell'immagine di stampa, manifestata da una fine linea bianca visibile sull'etichetta. Per evitare questo, è possibile impostare un valore per un ritiro minimo (0 – 1 mm), in base al quale viene ritirato il materiale etichette. Al prossimo avvio della stampa, l'area libera viene pressata. L'impostazione della lunghezza CMI ha effetto solo nella selezione del modo di ritiro "Ritiro ottimizzato".

**Network (Rete)**Sequenza di tasti: , , , , 

Troverete maggiori informazioni su quest'opzione menù nel Manuale a parte.

**Password (Passwort)**Sequenza di tasti: , , , , , **Operation (Funzionamento)****Password (Password)** Inserimento di una password numerica a 4 cifre.Tasto: **Protection configuration (Protezione configurazione)**

Le impostazioni della stampante possono essere modificate. (contrasto, velocità, modo d'esercizio, ...). La password evita modifiche in questo menu.

Tasto: **Protection favorites (Protezione preferiti)**

La protezione password impedisce l'accesso al menu preferiti.

Tasto: **Protection memory card (Protezione scheda memoria)**

Con la funzione scheda memoria è possibile salvare, caricare, ... etichette. All'inserimento della password, si deve differenziare, se l'utente deve avere il diritto di leggere etichette memorizzate oppure se non deve avere nessun diritto.

**Accesso integrale:** nessuna protezione con password**Solo lettura:** possibili solo accessi di lettura**Protetto:** accessi bloccatiTasto: **Protection printing (Protezione stampa)**

Nel caso che la stampante è collegata al PC, in certi casi può essere d'aiuto, se non è possibile lanciare manualmente una stampa. Con l'inserimento di una Password non è possibile lanciare una stampa manualmente dalla stampante.

**Network (Rete)****Password (Password)**

Inserimento di una password di 15 caratteri. Possono essere caratteri alfanumerici e caratteri speciali.

Tasto: **Protection HTTP (Protezione HTTP)**

E' possibile evitare la comunicazione via HTTP.

Tasto: **Protection Telnet (Protezione Telnet)**

Non è possibile variare le impostazioni della protezione Telnet.

Tasto: 

**Protection remote access** (Protezione accesso remoto) E' possibile impedire l'accesso da una interfaccia HMI esterna.

**AVVISO!**

Per eseguire una funzione bloccata, occorre prima inserire la password valida. Dopo aver inserito la password corretta, viene effettuata la funzione desiderata.

**Interface (Interfacce)**Sequenza di tasti: , , , , , , , **COM1 / Baud / P / D / S****COM1:**

0 - interfaccia seriale Off  
1 - interfaccia seriale On  
2 - interfaccia seriale On, non viene indicato nessun messaggio in caso d'errore nella trasmissione.

**Baud rate (bauds):**

Indica quanti bit vengono trasmessi il secondo: velocità di trasmissione.  
Valori impostabili: 1200, 2400, 4800, 9600, 19200, 38400, 57600, 115200.

**P = Parity (Parità):**

N - No parity; E - Even; O - Odd  
È necessario verificare che le impostazioni corrispondono a quelle della porta seriale del PC.

**D = Data bits (Bits dei dati):**

Impostazione dei Bit di dati. Valori impostabili: 7 oppure 8 Bits.

**S = Stop bit (Bit di stop):**

Indicazione dei bits di stop tra i Bytes. Valori impostabili: 1 oppure 2 Bit di stop.

Tasto: 

**Start/stop sign**  
(Carattere di partenza/finale)



**SOH:** Inizio della trasmissione del blocco di dati → formato HEX 01**ETB:** Fine della trasmissione del blocco di dati → formato HEX 17Tasto: 

**Data memory**  
(Memoria dati)

**Standard (Standard):** Dopo l'avvio di un ordine di stampa dati vengono ricevuti finché il buffer di stampa è pieno.**Extended (Estesa):** Durante la stampa i dati vengono ricevuti e rielaborati.**Off:** Durante la stampa non vengono ricevuti dati ulteriori.Tasto: 

**Port test**  
(Port test)



Controllo se dati trasmetteranno attraverso l'interfaccia.

Premere i tasti  e  per selezionare "In generale" (ON). Premere il tasto  e vengono così stampati i dati che sono stati inviati attraverso una porta preferita (COM1, LPT, USB, TCP/IP).

**Emulation (Emulazione)**Sequenza di tasti: , , , , , , , , 

**Protocol**  
(Protocollo)

**CVPL:** Carl Valentin Programming Language**ZPL:** Zebra® Programming Language

Con i tasti  e  è possibile scegliere il protocollo. Premere il tasto  per confermare la selezione. La stampante si riavvia e trasforma internamente i comandi ZPL II® in comandi CVPL e li esegue.

Tasto: 

**Printhead resolution**  
(Risoluzione testina di stampa)

Se l'emulazione ZPL® II è attivata, è necessario impostare la risoluzione della testina di stampa della stampante emulata.

**AVVISO!**

Se la risoluzione della testina di stampa del sistema Zebra® differisce da quella del modulo per la stampa diretta Valentin, le dimensioni degli oggetti (ad es. testi, grafici) non corrispondono con precisione.

Tasto: **Drive mapping  
(Assegnazione unità)**

L'accesso ai drive Zebra® viene deviato su drive Valentin corrispondenti.

**AVVISO!**







Poiché i font interni contenuti nelle stampanti Zebra® non sono disponibili nei sistemi Valentin, possono presentarsi delle differenze minime nella scrittura.

Tasto: **PJL – Printer Job  
Language  
(PJL – Printer Job  
Language)**

Possono essere visualizzate le informazioni di stato relative al job di stampa.

**Date & Time (Data & Ora)**Sequenza di tasti: , , , , , , , , , **Set date/time  
(Modificare la data e l'ora)**

La prima riga del display indica la data attuale. La seconda riga mostra l'ora attuale.

Premere i tasti  e  per passare al prossimo campo. Con i tasti  e  è possibile aumentare / diminuire i valori impostati.Tasto: **Summertime  
(Orario estivo)****On:** La stampante passa automaticamente dall'ora estiva all'ora invernale (e viceversa).**Off:** L'entrata in vigore dell'ora legale non viene rilevata automaticamente e l'ora non viene quindi cambiata.Tasto: **Start of summertime -  
format  
(Inizio del orario estivo -  
formato)**

Con questa funzione si sceglie il formato, di come deve essere impostato l'ora estiva.

DD = Giorno

WW = Settimana

WD = Giorno della settimana

MM = Mese

YY = Anno

next day = viene considerato il prossimo giorno

Tasto: **Start of summertime - date  
(Inizio del orario estivo -  
data)**

Impostare la data da quando deve iniziare l'orario estivo.

Con l'aiuto di questa funzione, si inserisce la data, dalla quale deve iniziare l'ora estiva. Questo inserimento si riferisce al formato selezionato prima.

Tasto: **Start of summertime - time  
(Inizio del orario estivo -  
orario)**

Impostare l'orario da quando deve iniziare l'ora estiva.

Con l'aiuto di questa funzione, si inserisce l'orario da, quando deve iniziare l'ora estiva.

Tasto: **End of summertime -  
format  
(Fine del orario estivo -  
formato)**

Con questa funzione, si seleziona il formato per impostare la fine dell'ora estiva.

Tasto: **End of summertime - date  
(Fine del orario estivo -  
data)**

Con l'aiuto di questa funzione è possibile impostare la data, da quando deve finire la data estiva. Questa impostazione si riferisce al formato selezionato prima.

Tasto: **End of summertime - time  
(Fine del orario estivo -  
orario)**

Con l'aiuto di questa funzione, si inserisce l'orario a qui deve terminare l'ora estiva.

Tasto: **Time shifting  
Spostamento dell'ora**

Con l'aiuto di questa funzione, si può impostare lo spostamento dell'orario (ora estiva/invernale) in ore e minuti.

## Service Functions (Funzioni d'assistenza)



### AVVISO!

La stampante è dotata di un sottomenu Funzioni d'assistenza che consente al rivenditore e/o alla ditta costruttrice, di offrire un supporto rapido in caso d'assistenza tecnica. Tutte le informazioni dell'impostazione si ottengono direttamente dalla stampante. Informazioni supplementari, per esempio la versione del Firmware o dei fonts si ottengono dal menu base.

Sequenza di tasti: **F**, , , , , , , , , , 

#### Label parameters (Parametri dell'etichetta)

Indicazione dei parametri dell'etichetta espressi in Volt.

**A:** Viene visualizzato il valore minimo.

**B:** Viene visualizzato il valore massimo.

**C:** Viene visualizzato il valore della soglia di commutazione. Viene rilevato durante la misurazione ed è possibile modificarlo.

Tasto: 

#### Photocell configuration (Regolazioni della fotocellula)

Questa funzione consente di regolare il livello della fotocellula.

Nel caso che risultano problemi nel posizionare oppure durante la misurazione dell'etichetta, è possibile regolare manualmente i parametri. Attenzione: impostare un valore Hub alto (per l'etichetta >3 V, per il taglio <1 V).

Tasto: 

#### Photocell parameters (Parametri della fotocellula)

**TLS:** Indica il livello fotoelettrico, luce passante, espresso in volt.

**RLS:** Indica il livello fotoelettrico della luce riflessa espresso in volt.

**SLS:** Indica il livello fotoelettrico del distributore espresso in volt.

**RC:** Indica lo stato della fotocellula del nastro di trasferimento (0 oppure 1).

**H:** Indica il valore 0 o 1 per la posizione della testina di stampa.

0 = testina di stampa in basso

1 = testina di stampa in alto

Tasto: 

#### Paper counter (Metri stampati)

**D:** Indica quanti metri ha stampato la testina di stampa

**G:** Indica quanti metri ha stampato la stampante.

Tasto: 

#### Heater resistance (Resistenza dot)

All'installazione della testina di stampa è necessario impostare il valore Ohm indicato sulla testina di stampa per ottenere una stampa corretta.

Tasto: 

#### Printhead temperature (Temperatura della testina di stampa)

Indica la temperatura della testina di stampa. Se la testina di stampa raggiunge una temperatura troppo elevata, l'ordine di stampa viene interrotto e un avviso d'errore appare sul display della stampante.

Tasto: 

#### Motor ramp (Motore Rampa)

Quanto maggiore è il valore '++'-imposto, tanto più lenta sarà l'accelerazione del motore d'avanzamento.

Quanto minore sarà il valore '--', tanto più rapida sarà la frenatura del motore d'avanzamento.

Tasto: 

#### Print examples (Esempi di stampa)

Attivando questa voce di menu si ottiene una stampa con tutte le impostazioni del modulo per la stamp.

##### Settings (Parametri):

Attivando questa voce del menu si ottiene una stampa con tutte le impostazioni. Ad esempio: velocità, materiale delle etichette, nastro di trasferimento etc.

##### Bar codes (Codici a barre):

Attivando questa voce del menu si ottiene una stampa di tutti i codici a barre disponibili.

##### Fonts (Fonts):

Attivando questa voce del menu si ottiene la stampa di tutti i font vettoriali e dei bitmap fonts.

Tasto: 

#### Input (Entrate)

Visualizzazione del livello per entrate.

0 = Low

1 = High

Tasto: **Output  
(Uscite)**

Visualizzazione del livello per uscite.

0 = Low  
1 = HighTasto: **I/O status  
(Stato I/O)**

Vengono conteggiati i risultati rilevanti e protocollati poi insieme in memoria RAM. Non appena si spegne la macchina, il protocollo va perso.

**RInt** = Real Interrupts



Conteggia direttamente all'Interrupt gli impulsi di ingresso di avvii.

**Dbnc** = Debounced

Conteggia gli impulsi di ingresso di avvii più lunghi del tempo di antirimbato impostato. Solo questi impulsi di avvio possono attivare una stampa. Se un impulso di avvio è troppo breve, non è in grado di attivare alcuna stampa. Si riconosce nel fatto che RInt conteggia, Dbnc invece no.

**NPrn** = Not Printed

Conteggia gli impulsi di ingresso di avvii che non hanno attivato alcuna stampa. Le cause di questo sono: nessun ordine di stampa attivo, ordine di stampa interrotto (manualmente o a causa di un errore) oppure il sistema di stampa è ancora impegnato nello svolgimento di un ordine di stampa.

**PrtStrtReset** = Resetta tutti i contatori.**PrtStrtTime** = Lunghezza misurata dell'ultimo impulso di avvio in ms.Tasto: **Cutter photocell  
(Fotocellula  
della )taglierina**1 = La stampante è dotata di taglierina.  
0 = La stampante non è dotata di taglierina.**Cutter Home (CH)  
(Taglierina Home (CH))**1 = La taglierina si trova in posizione di partenza pronta per tagliare.  
0 = La taglierina non si trova in posizione di partenza e deve essere portata in posizione prima che l'ordine di taglio può essere lanciato.Tasto: **Online/Offline  
(Online/Offline)**Questa funzione viene attivata per esempio quando si deve sostituire il nastro colore. In tal modo si evita che il job di stampa venga elaborato malgrado l'apparecchio non sia ancora pronto. Se la funzione è attivata, il tasto  permette di passare dalla modalità Online alla modalità Offline e viceversa. Lo stato attuale è indicato sul display. Standard: Disattivata.**Online:** I dati vengono trasmessi mediante delle interfacce. I tasti della tastiera a membrana sono attivi soltanto se si è passati alla modalità Offline premendo il tasto .**Offline:** I tasti della tastiera a membrana sono di nuovo attivi, ma i dati ricevuti non vengono più elaborati. La ricezione dei nuovi job di stampa avverrà nuovamente quando l'apparecchio sarà di nuovo in modalità Online.Tasto: **Transfer ribbon warning  
(Preallarme nastro di  
trasferimento)****TRB = Transfer ribbon advance warning (Preallarme nastro di trasferimento):**

Se è stata attivata questa funzione, prima che il nastro di trasferimento finisca completamente, sarà attivato un segnale acustico.

**Warning diameter (Diametro warning):**

Impostazione del diametro di preallarme nastro di trasferimento.

Se a questo punto si imposta un valore in mm, quando il diametro del rotolo del nastro di trasferimento raggiungerà il valore impostato, verrà attivato un segnale acustico.

**Ribbon advance warning mode (Modalità di esercizio di preallarme):****Warning (Avvertenza):** al raggiungimento del diametro di preallarme viene impostato il relativo output I/O.**Reduced print speed (Velocità ridotta):** velocità alla quale la velocità di stampa deve essere ridotta.**Error (Errore):** al raggiungimento del diametro di preallarme, il sistema di stampa rimane fermo con 'Troppo poco nastro di trasferimento'.**Reduced print speed (Velocità ridotta):**

Impostazione della velocità di stampa ridotta in mm/s. Questa può essere impostata nei limiti della normale velocità di stampa.

Tasto: **Zero point adjustment  
in Y direction  
(Calibrazione punto zero  
alla direzione Y)**

L'impostazione del valore avviene in 1/100 mm.  
Nel caso che, dopo la sostituzione della testina di stampa, la stampa non si trova sullo stesso punto di prima è possibile correggere la differenza alla direzione stampa.

**AVVISO!**

Il punto zero viene calibrato durante la produzione e deve essere regolato solamente dopo la sostituzione della testina di stampa. È importante che la regolazione viene effettuata da personale addestrato.

Tasto: **Zero point adjustment  
in X direction  
(Calibrazione punto zero  
alla direzione X)**

L'impostazione del valore avviene in 1/100 mm.  
Nel caso che, dopo la sostituzione della testina di stampa, la stampa non si trova sullo stesso punto di prima è possibile correggere la differenza trasversalmente alla direzione di stampa.

**AVVISO!**

Il punto zero viene calibrato durante la produzione e deve essere regolato solamente dopo la sostituzione della testina di stampa. È importante che la regolazione viene effettuata da personale addestrato.

Tasto: **Print length +/-  
(Lunghezza stampa +/-)**

Impostazione della correzione dell'immagine di stampa in percentuale.  
Grazie ad influssi meccanici (ad es. dimensioni rulli) l'immagine di stampa può essere stampata ingrandita o anche rimpicciolita rispetto alle dimensioni originali.  
Valori impostabili: +10.0 % ... -10.0 %

Tasto: **Write log files on MC  
(Scrivere i log file su MC)**

Attraverso questo comando, si scrivono diversi log file su un supporto di memorizzazione presente (scheda MC). Dopo il messaggio 'Finito', è possibile rimuovere il supporto di memorizzazione.

I files si trovano nella directory 'log':

**LogMemErr.txt:** errori protocollati con informazioni aggiuntive come data/ora e nome file/numero riga (per sviluppatore)

**LogMemStd.txt:** registrazione di eventi selezionati

**LogMemNet.txt:** i dati inviati per ultimo attraverso la porta 9100

**Parameters.log:** tutti i parametri di stampa in forma leggibile per l'utente

**TaskStatus.txt:** gli stati di tutti i task stampante

**Main Menu (Menu base)**



















Dopo l'accensione della stampante per etichette, viene visualizzato il menu di base. Esso mostra informazioni quali ad esempio il tipo di stampante, la data e l'ora corrente, il numero di versione del firmware e i dispositivi FPGA utilizzati.

Questo avviso appare solamente per alcuni secondi. Dopo di ciò passa automaticamente alle prime informazioni.

Premere nuovamente il tasto  per visualizzare seguente avviso.

## Scheda Compact Flash / Chiavetta USB\*

Per utilizzare il menu memory potete usare i tasti della tastiera a membrana della stampante per etichette o i vari tasti funzione di una tastiera USB collegata.

		Riporta al menu precedente.
		All'interno della funzione <i>Load layout</i> (Caricare layout): consente di passare a File Explorer. File Explorer: consente di passare al menu contestuale (context menu).
		Contrassegna un file/una directory qualora sia possibile una selezione multipla.
		Menu principale: seleziona il menu Memory. File Explorer: crea un nuovo file.
		Esegue la funzione corrente sul file / la directory corrente.
		Consente di passare alla directory superiore.
		Permette di passare alla directory attualmente evidenziata.
		Permette di scorrere verso l'alto all'interno della directory corrente.
		Permette di scorrere verso il basso all'interno della directory corrente.

### Define user directory (Definire directory utente)

Configura l'elenco standard in quale vengono depositi i file da elaborare.



#### AVVISO!

Una directory utente deve essere definita:

- prima che un'utenza o una navigazione avvenga attraverso il menu Memory.
- quando la formattazione della scheda CF è stata eseguita al PC e quindi la directory STANDARD non è stata creata automaticamente.

```
File Explorer
A:\
[Drives]
-><STANDARD>
<DIR_1>
```

```
Context Menu
A:
->Set as user dir
Format
Copy
```



Permette di accedere al menu Memory.



Richiama File Explorer.



Seleziona la directory.



Visualizza le funzioni disponibili.



Seleziona la funzione *Set as user dir* (come directory utente).



Conferma la selezione.



Riporta al menu principale.

Richiamando successivamente il menu Memory, compare la directory selezionata come *Directory utente*.

### Load layout (Caricare layout)

Caricare un layout all'interno di una directory utente definita. La funzione permette un accesso rapido al layout desiderato, poiché sono visualizzati solamente file di layout e le directory sono nascoste.

```
Load layout
A:\STANDARD
->File_name1.prn
File_name2.prn
File_name3.prn
File_name4.prn
```



Permette di accedere al menu Memory.



Conferma il layout.



Conferma la selezione.

La finestra di indicazione del numero di copie viene visualizzata automaticamente.



Seleziona il numero di layout da stampare.



Avvia il lavoro di stampa.



#### AVVISO!

Qui la directory NON può essere cambiata. Per cambiare la directory È NECESSARIO utilizzare la funzione *Change directory* (Cambia directory) in File Explorer.

\* non disponibile



## File Explorer

Il File Explorer è il sistema di gestione dati del sistema di stampa. Le funzioni principali per l'interfaccia del menu Memory sono messi a disposizione in File Explorer.

Nella schermata della Directory utente, premere il tasto **F** per accedere al File Explorer.

È possibile selezionare le seguenti funzioni:







- Cambiare drive o directory
- Cambiare file
- Salvare layout o configurazione
- Eliminare file(s)
- Formattare scheda CF
- Copiare file(s)

### Change directory (Cambiare directory)

```
File Explorer
A:\
[Drives]
-><STANDARD>
<DIR_1>

File Explorer
A:\STANDARD\
-><..>
  layout01
  layout02
```





Selezione del drive o della directory dove sono memorizzati i file.

-  Permette di accedere al menu Memory.
- F** Richiama File Explorer.
- ,  + ,  Seleziona la directory.
-  Conferma la selezione.  
La directory selezionata viene visualizzata.

### Load file (Caricare file)

```
Load file
A:\STANDARD\
<..>
->layout01
  layout02
```

Carica il file prescelto. Può trattarsi di una configurazione, di un layout, ecc., precedentemente salvato.

-  Permette di accedere al menu Memory.
- F** Richiama File Explorer.
-  +  Seleziona un file.
-  Il file selezionato viene caricato.







### AVVISO!

Se il file selezionato è un layout, allora è possibile inserire immediatamente il numero delle copie da stampare.

### Save layout (Memorizzare layout)

```
Save file
A:\STANDARD
->Save layout
  Save config.
  noname
```

Salva il layout caricato attualmente, con il nome selezionato.





-  Permette di accedere al menu Memory.
- F** Richiama File Explorer.
-  Consente di passare al menu *Save file* (Salvare file).
- ,  Seleziona la funzione *Save layout* (Memorizzare layout).
-  Conferma la selezione.

Se è collegata una tastiera USB, è possibile assegnare per *noname* un nuovo nome file.

### Save configuration (Memorizzare configurazione)

```
Save file
A:\STANDARD
Save layout
→ Save config.
config.cfg
```

Salva la completa configurazione stampante attuale, con il nome selezionato.







-  Permette di accedere al menu Memory.
-  Richiama File Explorer.
-  Consente di passare al menu *Save file* (Salvare file).
-  Seleziona la funzione *Save configuration* (Memorizzare configurazione).
-  Conferma la selezione.

Se è collegata una tastiera USB, è possibile assegnare per *config.cfg* un nuovo nome file.

### Delete file (Cancellare file)

```
File Explorer
A:\STANDARD\
layout01 *
→ layout02 *
layout03
layout04
Context menu
2 objects marked
→ Delete
Copying
```

Elimina definitivamente uno o più file o directory. Se viene eliminata una directory, vengono eliminati anche i file e le sottodirectory che essa contiene.

-  Permette di accedere al menu Memory.
-  Richiama File Explorer.
-  Seleziona un file.
-  Contrassegnare i file da eliminare. Le voci contrassegnate sono contraddistinte dal segno \*. Eseguite questa procedura finché tutti i file o le directory prescelti e contrassegnati non sono stati cancellati.
-  Consente di passare al menu contestuale.
-  Seleziona la funzione *Delete* (Cancellare).
-  Conferma la selezione.

### Formatting (Formattare)







Formatta una scheda di memoria senza possibilità di annullare l'operazione.



#### AVVISO!

Le chiavette USB non possono essere formattate dal sistema di stampa diretta!

```
File Explorer
DRIVES
→ A: 954Mb free
U: No media
Context menu
A:\
Set as user dir
→ Formatting
Copy
```

-  Permette di accedere al menu Memory.
-  Richiama File Explorer.
-  Seleziona l'unità da formattare.
-  Consente di passare al menu contestuale (context menu).
-  Seleziona la funzione *Formatting* (Formattare).
-  Conferma la selezione.

## Copying (Copiare)

```
File Explorer
A:\STANDARD\
layout01 *
→ layout02 *
layout03
layout04
```

```
Context menu
2 objects marked
Delete
→ Copying
```

```
Select Destination
DRIVES
→ A: 954Mb free
```

Crea un duplicato del file originale o della directory originale consentendo di eseguire delle modifiche senza alterare l'originale.



Permette di accedere al menu Memory.



Richiama File Explorer.



Seleziona un file.



Contrassegnare i file da copiare. Le voci contrassegnate sono contraddistinte dal segno \*. Eseguite questa procedura finché tutti i file o le directory prescelti e contrassegnati non sono stati copiati.



Consente di passare al menu contestuale (context menu).



Seleziona la funzione *Copying* (Copiare).



Specifica la destinazione della procedura di copia.



Seleziona il percorso di memorizzazione di destinazione.



Conferma la selezione.

## Filtro:

### È possibile solo in associazione con una tastiera USB.

Se è collegata una tastiera USB, con determinate funzioni è possibile specificare una maschera di filtraggio o il nome di un file da memorizzare. Questa immissione viene visualizzata sulla riga del percorso. La maschera di filtraggio consente di cercare determinati file. Immettendo la parola "L", ad esempio, vengono visualizzati soltanto i file il cui nome inizia con la stringa di caratteri "L" (non viene fatta differenza fra maiuscole e minuscole).

#### Senza filtri

```
Load layout
A:\STANDARD
→ First_file.prn
Layout_new.prn
Sample.prn
12807765.prn
```

#### Con filtri

```
Load layout
L
→ Layout_new.prn
```

**Dati tecnici**

	Vita II 103/8 T	Vita II 104/8	Vita II 106/12	Vita II 106/24	Vita II 108/12 T
Risoluzione	203 dpi	203 dpi	300 dpi	600 dpi	300 dpi
Max. velocità di stampa	200 mm/s	200 mm/s	150 mm/s	100 mm/s	150 mm/s
Larghezza di stampa	104 mm	104 mm	105.7 mm	105.7 mm	108.4 mm
Larghezza di passaggio					
Standard	116 mm	116 mm	116 mm	116 mm	116 mm
Modo taglio	112 mm	112 mm	112 mm	112 mm	112 mm
Testina di stampa	Flat Type <sup>1</sup>	Flat Type <sup>2</sup>	Flat Type <sup>2</sup>	Flat Type <sup>2</sup>	Flat Type <sup>1</sup>
<b>Etichette</b>					
Etichette o modulo continuo in rotolo o piegati a fisarmonica	Carta, cartoncino, tessuto, plastica				
Max. spessore materiale	220 gr/m <sup>2</sup> (maggiore su richiesta)				
Min. larghezza etichette	12 mm				
Min. altezza etichette					
Standard	5 mm				
Modo taglio oppure distributivo	15 mm				
Max. altezza etichette	6000 mm	6000 mm	3000 mm	1000 mm	3000 mm
Max. diametro del rotolo					
Svolgitore interno	180 mm				
Avvolgitore interno	---				
Diametro dell'anima interna	40 mm / 75 mm (opzione)				
Avvolgimento	esterno o interno				
Sensore etichette	Luce passante e riflessione dal basso				
<b>Nastro di trasferimento</b>					
Colore	esterno o interno				
Max. diametro del rotolo	Ø 80 mm				
Diametro dell'anima interna	25,4 mm / 1"				
Max. lunghezza	450 m				
Max. larghezza	110 mm				
<b>Dimensioni (mm)</b>					
Larghezza x Altezza x Profondità	236 x 238 x 374				
Peso	11 kg				
<b>Elettronica</b>					
Processore	High Speed 32 Bit				
Memoria di lavoro (RAM)	16 MB				
Slot	per scheda Compact Flash Tipo I				
Batteria	per orologio in tempo reale (salvataggio dei dati in caso di scollegamento da rete elettrica)				
Segnale di avviso	Segnale acustico in caso di errore				
<b>Interfacce</b>					
Seriale	RS-232C (bis 115200 Baud)				
Parallela	SPP				
USB	2.0 High Speed Slave				
Ethernet	10/100 Base T, LPD, RawIP-Printing, DHCP, HTTP, FTP				
WLAN (opzione)	Module 802.11 b/g/n WEP, WPA, WPA-PSK, WPA2, WPA2-PSK, EAP				

<sup>1</sup> = Trasferimento diretto

<sup>2</sup> = Trasferimento termico

<b>Condizioni d'esercizio</b>	<b>Vita II 103/8 T</b>	<b>Vita II 104/8</b>	<b>Vita II 106/12</b>	<b>Vita II 106/24</b>	<b>Vita II 108/12 T</b>
Tensione nominale	110 ... 230 V AC / 50-60 Hz				
Max. potenza assorbita	275 VA				
Corrente nominale	2,5 A				
Temperatura d'esercizio	5 ... 35 °C				
Max. umidità dell'aria	max. 80 % (non condensando)				
<b>Pannello di controllo</b>					
Tasti	Prova di stampa, menu funzioni, conteggio, scheda CF, avanzamento, invio, 4 x cursore				
Display LCD	Display grafico 132 x 64 pixel				
<b>Parametri</b>					
	Data, ora, alternate impostazioni in 20 lingue (altre su richiesta) Parametri dell'apparecchio, dell'etichette, interfacce, password, variabili				
<b>Controlli</b>					
Interruzione stampa in caso di	Fine del nastro a trasferimento termico / Fine delle etichette / Testina di stampa aperta				
Stampa dello stato	Stampa delle impostazioni dell'apparecchio, come ad esempio resa, parametri di fotocellula, interfaccia e rete Stampa dei caratteri interni e di tutti i codici a barre supportati				
<b>Font</b>					
Caratteri	6 caratteri bitmap 8 caratteri vettoriali / caratteri TrueType 6 caratteri proporzionali Altri caratteri su richiesta				
Set di caratteri	Windows 1250 fino a 1257, DOS 437, 850, 852, 857, UTF-8 Sono supportati tutti i caratteri dell'Europa occidentale e orientale, latini, cirillici, greci e arabi (opzione) Altri set di caratteri su richiesta				
Caratteri bitmap	Dimensioni in larghezza e altezza 0,8 ... 5,6 Fattore di ingrandimento 2 ... 9 Orientamento 0°, 90°, 180°, 270°				
Caratteri vettoriali / Caratteri TrueType	Dimensioni in larghezza e altezza 1 ... 99 mm Fattore di ingrandimento continuo Orientamento 0°, 90°, 180°, 270°				
Attributi caratteri	Dipendenti dal tipo di carattere grassetto, corsivo, inverso, verticale				
Passo dei caratteri	Variabile				
<b>Codici a barre</b>					
Codici a barre 1D	CODABAR, Code 128, Code 2/5 interleaved, Code 39, Code 39 extended, Code 93, EAN 13, EAN 8, EAN ADD ON, GS1-128, Identcode, ITF 14, Leitcode, Pharmacode, PZN 7 Code, PZN 8 Code, UPC-A, UPC-E				
Codici a barre 2D	Aztec Code, CODABLOCK F, DataMatrix, GS1 DataMatrix, MAXICODE, PDF 417, QR Code				
Codici compositi	GS1 DataBar Expanded, GS1 DataBar Limited, GS1 DataBar Omnidirectional, GS1 DataBar Stacked, GS1 DataBar Stacked Omnidirectional, GS1 DataBar Truncated				
	Tutti i codici a barre sono diversi per altezza, larghezza del modulo e rapporto Orientamento 0°, 90°, 180°, 270° A scelta cifra di controllo e stampa in caratteri ottici				
<b>Software</b>					
Configurazione	ConfigTool				
Controllo di processo	NiceLabel				
Software di etichette	Labelstar Office Lite, Labelstar Office				
Windows driver	Windows 7® - Windows 10® 32/64 Bit Windows Server 2008® (R2) - Windows Server 2019®				

Ci si riserva il diritto di apportare in qualunque momento eventuali modifiche tecniche.

## Pulizia



### PERICOLO!

Pericolo di morte per scarica elettrica!

⇒ Prima di tutti i lavori di manutenzione, scollegare dalla rete elettrica la stampante e attendere brevemente che l'alimentatore si sia scaricato.



### AVVISO!

Per la pulizia dell'apparecchio, sono consigliati dispositivi di protezione personale, come occhiali protettivi e guanti.

Lavori di manutenzione	Frequenza
Pulizia generale.	In caso di necessità.
Pulizia del rullo di trazione del nastro.	Ad ogni cambio del nastro di trasferimento o in caso di danneggiamento dell'immagine di stampa.
Pulizia del rullo pressore.	Ad ogni cambio del rotolo etichette o in caso di danneggiamento dell'immagine di stampa e del trasporto etichette.
Pulizia della testina di stampa.	<b>Stampa termica diretta:</b> Ad ogni cambio del rotolo etichette. <b>Stampa per trasferimento termico:</b> Ad ogni cambio del nastro di trasferimento o in caso di danneggiamento dell'immagine di stampa.
Pulizia della fotocellula.	Alla sostituzione del rotolo di etichette.



### AVVISO!

Devono essere osservate le norme per l'uso di isopropanolo (IPA). In caso di contatto con la pelle o con gli occhi, risciacquare bene con acqua corrente. In caso di irritazione persistente, contattare un medico. Assicurarsi che vi sia una aerazione sufficiente.



### AVVERTENZA!

Pericolo di incendio dovuto al solvente per etichette facilmente infiammabile!

⇒ Se si usa un solvente per etichette, rimuovere imperativamente polvere e sporco dalla stampante per etichette.

## Pulizia generale



### ATTENZIONE!

Danneggiamento della stampante con detergenti aggressivi!

⇒ Non utilizzare abrasivi o solventi per la pulizia delle superfici esterne o dei gruppi costruttivi.

⇒ Rimuovere la polvere e filamenti di carta dalla zona di stampa con un pennello morbido o l'aspirapolvere.

⇒ Pulire le superfici esterne con un detergente universale.

## Pulizia del rullo di trazione del nastro

Sporcizia sul rullo di stampa può causare una cattiva qualità di stampa e malfunzionamenti nel trasporto del materiale.

- Aprire il coperchio della stampante.
- Rimuovere il nastro transfer.
- Rimuovere depositi con detergenti per rulli ed un panno morbido.
- Se il rullo presenta danneggiamenti, sostituirlo.

## Pulizia del rullo pressore

Sporcizia sul rullo di stampa può causare una cattiva qualità di stampa e malfunzionamenti nel trasporto del materiale.



### ATTENZIONE!

Danneggiamento del rullo pressore!

⇒ Per la pulizia del rullo pressore, non utilizzare oggetti affilati, appuntiti o duri.

- Ruotare la leva in senso antiorario per sollevare la testina di stampa.
- Rimuovere le etichette e il nastro transfer dalla stampante.
- Rimuovere depositi con detergenti per rulli ed un panno morbido.
- Se il rullo presenta danneggiamenti, sostituirlo.

## Pulizia della testina di stampa

Durante la stampa la testina di stampa si sporca, perciò è necessario pulirla in intervalli regolari. La regolazione della pulizia dipende dalle ore di esercizio, dall'ambiente p.e. polveroso ecc.



### ATTENZIONE!

Danneggiamento della testina di stampa!

⇒ Per la pulizia della testina di stampa, non utilizzare oggetti affilati, appuntiti o duri.

⇒ Non toccare lo strato di vetro protettivo della testina di stampa.

- Ruotare la leva in senso antiorario per sollevare la testina di stampa.
- Rimuovere le etichette e il nastro transfer dalla stampante.
- Pulire la superficie della testina di stampa con un pennino speciale per pulizia o un bastoncino d'ovatta imbevuto d'alcol.
- Prima di rimettere in servizio la stampante, lasciar asciugare la testina di stampa per 2 - 3 minuti.

## Pulizia della fotocellula delle etichette



### ATTENZIONE!

Danneggiamento della fotocellula!

⇒ Per la pulizia della fotocellula, non utilizzare oggetti affilati o acuminati o detergenti.

La fotocellula delle etichette può accumulare impurità a causa della polvere di carta. Questo può comprometterne il riconoscimento della parte iniziale delle etichette.

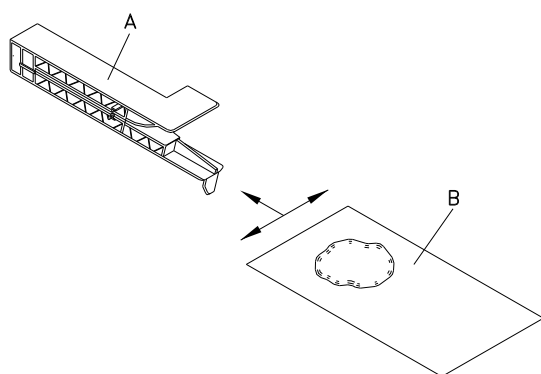

- Ruotare la leva in senso antiorario per sollevare la testina di stampa.
- Rimuovere le etichette e il nastro transfer dalla stampante.
- Pulire il relè fotoelettrico (A) con uno spray a gas compresso. È assolutamente necessario attenersi alle istruzioni riportate sulla confezione.
- È possibile rimuovere lo sporco nel relè fotoelettrico utilizzando una carta detergente (B), precedentemente inumidita con il pulitore per testine di stampa e per cilindri da stampa.
- Reinserrire le etichette e il nastro transfer.





Guia rápido e informações sobre  
a segurança do produto

Português

Copyright: Carl Valentin GmbH.

Informações sobre o conteúdo do fornecimento, aspeto, capacidades, medidas e pesos correspondem às do nosso conhecimento na altura de impressão.

Reserva-se o direito de alterações.

Nenhuma parte da presente obra pode ser reproduzida (impressão, fotocópia ou outro método) sem a autorização por escrita da Carl Valentin GmbH, nem processada, multiplicada ou distribuída utilizando sistemas eletrónicos.

Podem surgir divergências entre a documentação e o aparelho devido ao seu constante desenvolvimento.

Podem consultar a edição atual na página [www.carl-valentin.de](http://www.carl-valentin.de).

### **Marca registada**

Todas as marcas ou marcas comerciais mencionadas são marcas registadas ou marcas comerciais registadas dos respetivos proprietários e podem não ser identificadas em separado. A ausência da identificação não permite pressupor que não se trate de uma marca ou marca comercial registada.

As impressoras de etiquetas da Carl Valentin GmbH cumprem as seguintes diretivas de segurança:

- CE** Diretiva de baixa tensão (2014/35/UE)
- Diretiva da Compatibilidade Eletromagnética (2014/30/UE)



### **Carl Valentin GmbH**

Postfach 3744  
78026 Villingen-Schwenningen  
Neckarstraße 78 – 86 u. 94  
78056 Villingen-Schwenningen

Phone +49 7720 9712-0  
Fax +49 7720 9712-9901

E-Mail [info@carl-valentin.de](mailto:info@carl-valentin.de)  
Internet [www.carl-valentin.de](http://www.carl-valentin.de)

---

## Índice

Utilização correta	148
Instruções de segurança	148
Descarte ecológico	148
Requisitos operacionais	149
Desembalar a impressora de etiquetas	152
Conteúdo	152
Instalar a impressora de etiquetas	152
Ligar a impressora de etiquetas	152
Colocação em funcionamento a impressora de etiquetas	152
Colocar um rolo de etiquetas no modo de corte	153
Colocar uma fita de transferência	154
Print Settings (Inicialização da impressão)	155
Label Layout (Disposição das etiquetas)	155
Device Settings (Parâmetros do aparelho)	156
Network (Rede)	158
Password (Palavra-chave)	158
Interface (Interfaces)	159
Emulation (Simulação)	159
Date & Time (Data & Hora)	160
Service Functions (Funções de serviço)	161
Main Menu (Menu inicial)	163
Compact Flash Card	164
Especificações técnicas	168
Limpar o rolo de tração da fita de transferência	170
Limpar o tambor de impressão	171
Limpar a cabeça de impressão	171
Limpar a célula fotoelétrica de etiquetas	171

## Utilização correta

- A impressora de etiquetas foi construída de acordo com o estado atual da tecnologia e as regras de segurança técnica aprovadas. Todavia, a sua utilização poderá apresentar perigos para a vida e saúde do utilizador ou de terceiros ou causar danos na impressora de etiquetas e outros danos materiais.
- A impressora de etiquetas só pode ser utilizada em bom estado técnico, bem como conforme da finalidade prevista, sob consideração dos requisitos de segurança e dos perigos e sob observação das instruções de utilização. Nomeadamente avarias que possam comprometer a segurança devem ser imediatamente resolvidas.
- A impressora de etiquetas destina-se exclusivamente a impressão de material adequado e autorizado pelo fabricante. Qualquer outro tipo de utilização ou além do exposto é considerada uma utilização inadequada. O fabricante não se responsabiliza pelos danos resultantes da utilização inadequada, a responsabilidade é exclusivamente do utilizador.
- A utilização correta engloba também a observação das instruções de utilização, inclusive das prescrições e recomendações de manutenção do fabricante.

## Instruções de segurança

- A impressora de etiquetas foi concebida para redes de corrente com tensão alternada de 110 ... 230 V AC. A impressora de etiquetas deve ser ligada apenas às tomadas com condutor de proteção (PE).
- A impressora de etiquetas deve ser ligada apenas à aparelhos de baixa tensão de proteção.
- Antes de estabelecer ou desconectar ligações, todos os aparelhos envolvidos (computador, impressora, acessórios) devem ser desligados.
- A impressora de etiquetas apenas deve ser utilizada em ambientes secos e não deve ser sujeita a humidade (água de salpico, névoa, etc.).
- As medidas de manutenção e de conservação apenas podem ser realizadas por pessoal devidamente instruído.
- Os operados devem ser instruídos pelo proprietário de acordo com o manual de instruções.
- Se a impressora de etiquetas for utilizada com a tampa aberta, deve ser observado, que a roupa, os cabelos e bijutaria ou semelhante das pessoas não possam entrar em contacto com as partes rotativas descobertas.
- O dispositivo e as peças (por exemplo cabeça de impressão) podem aquecer durante a impressão. Durante o funcionamento não deve portanto tocar-se no mesmo, sendo que antes de substituição de material, desmontagens ou ajustes terá de deixar-se arrefecer.
- Nunca utilizar consumíveis inflamáveis.
- Existe o risco de ferimento no canto de corte. Se o canto de corte não for usado, encaixar o perfil de proteção.
- Apenas são permitidos os trabalhos e intervenções descritos nas instruções de utilização. Os trabalhos que excedam esse âmbito devem ser executados apenas pelo fabricante ou mediante consulta do mesmo.
- Intervenções incorretas em componentes eletrónicos e respetivos softwares podem causar avarias.
- Trabalhos incorretos ou alterações no aparelho podem ameaçar a segurança de funcionamento.
- Os trabalhos de assistência devem ser sempre efetuados numa oficina qualificada que possui as ferramentas e os conhecimentos técnicos necessários para efetuar os trabalhos relevantes.
- Estão colocadas várias indicações de aviso nos aparelhos, que alertam para os perigos. Não remover estes autocolantes, caso contrário os perigos deixam de estar identificados.



### **PERIGO!**

Perigo de vida devido à tensão de rede!

⇒ Não abra a caixa do aparelho.

## Descarte ecológico

Os fabricantes de aparelhos B2B encontram-se obrigados, a partir de 23.03.2006, a aceitar a devolução e a reaproveitarem aparelhos usados fabricados após 13.08.2005. Por princípio, estes aparelhos usados não podem ser entregues em locais de recolha municipais. Estes apenas podem ser reaproveitados e eliminados por parte do fabricante. Assim, os produtos identificados como sendo produtos da Valentin poderão, no futuro, ser remetidos à Carl Valentin GmbH. Os aparelhos usados serão assim processados de forma correta.

Desta forma, a Carl Valentin GmbH cumpre com todas as obrigações respeitantes à eliminação de aparelhos usados, possibilitando desta forma também uma venda dos seus produtos sem problemas. Apenas poderemos aceitar aparelhos enviados com as despesas de transporte pagas antecipadamente.

A platina eletrónica do sistema de impressão está equipada com uma bateria de lítio. Esta deve ser eliminada nos recipientes de recolha de baterias usadas do comércio ou junto dos organismos públicos de recolha.

Para mais informações, consulte a diretiva REEE ou a nossa página Internet [www.carl-valentin.de](http://www.carl-valentin.de).

## Requisitos operacionais

Os requisitos operacionais são condições prévias que devem ser asseguradas antes da colocação em funcionamento ou a operação dos nossos aparelhos e para assegurar uma operação segura e sem falhas.

Leia atentamente os Requisitos operacionais.

Caso tenha dúvidas em relação a implementação dos requisitos operacionais, contacte-nos ou contacte a assistência respetivamente responsável.

## Requisitos gerais

Até a sua instalação, os aparelhos devem ser transportados e armazenados dentro da embalagem original.

Os aparelhos não devem ser instalados ou colocados em funcionamento se os requisitos operacionais não estiverem satisfeitos.

A colocação em funcionamento, programação, operação, limpeza e conservação dos nossos aparelhos apenas devem ser realizadas após leitura atenta das nossas instruções.

Os aparelhos só podem ser utilizados por pessoal devidamente instruído.



### AVISO!

Recomendamos que efetue regularmente formações.

O conteúdo das formações são os capítulos 'Condições de funcionamento', 'Colocar fita de transferência' e 'Limpeza e Manutenção'.

Estas informações aplicam-se também a aparelhos de terceiros fornecidos por nós.

Só podem ser utilizadas peças sobressalentes e de substituição originais.

Relativamente às peças de substituição/desgaste, contacte o fabricante.

## Requisitos ao local de instalação

O local de instalação deve ser plano e não sujeito a choques, vibrações e correntes de ar.

Os aparelhos devem ser dispostos de modo a permitir uma operação otimizada e um acesso fácil para fins de manutenção.

## Instalação local da alimentação elétrica

A instalação da alimentação elétrica para a ligação dos nossos aparelhos deve corresponder aos regulamentos internacionais e prescrições daí derivadas. Entre estes contam-se principalmente as recomendações de uma das três seguintes comissões:

- Comissão Eletrotécnica Internacional (IEC)
- Comissão Europeia de Normalização Eletrotécnica (CENELEC)
- Associação dos Eletrotécnicos Alemãs (VDE)

Os nossos aparelhos foram construídos de acordo com a classe de proteção I da VDE e devem ser ligados a um condutor de proteção. A instalação local de alimentação elétrica deve possuir um condutor de proteção para conduzir as tensões de falha internas do aparelho.

## Características técnicas da alimentação elétrica

Tensão de rede e frequência:	Veja a placa de tipo
Tolerâncias admissíveis da tensão de rede:	+6 % ... -10 % do valor nominal
Tolerâncias admissíveis da frequência de rede:	+2 % ... -2 % do valor nominal
Fator de ruído admissível da tensão de rede:	≤ 5 %

### Medidas de resolução de interferências:

Em redes com problemas graves de interferências (por exemplo devido a utilização de sistemas de comando de tirístores) é necessário implementar no local medidas de resolução de interferências. Existem, por exemplo, as seguintes opções:

- Instalação de cabos de alimentação próprios aos nossos aparelhos.
- Em casos mais problemáticos, montar no cabo de alimentação e à frente dos nossos aparelhos um transformador separador capacitivamente desacoplado ou um outro aparelho de eliminação de interferências.

## Interferências e resistência contra perturbações

Interferências/emissões conforme EN 61000-6-3: 2007 sector industrial

- Tensão parasita em ligações conforme EN 55022: 09-2003
- Intensidade do campo perturbador conforme EN 55022: 09-2003
- Correntes harmónicas (retroalimentação à rede) segundo a diretiva EN 61000-3-2: 09-2006
- Flutuação de tensão segundo a diretiva EN 61000-3-3: 1955 + A1:2001 + A2:2005

Resistência contra interferências/imunidade conforme EN 61000-6-2: 2005 sector industrial

- Resistência contra descargas de eletricidade estática conforme EN 61000-4-2: 12-2001
- Campos eletromagnéticos conforme EN 61000-4-3: 11-2003, ENV 50204: 03-1995
- Resistência contra descargas elétricas rápidas (burst) conforme EN 61000-4-4: 07-2005
- Resistência contra sobrecargas de tensão (surge) conforme EN 61000-4-5: 12-2001
- Tensões de alta-frequência conforme EN 61000-4-6: 12-2001
- Interrupções e variações de tensão conforme EN 61000-4-11: 02-2005



### AVISO!

Este é um dispositivo da classe A; Este dispositivo pode causar falhas no ambiente doméstico; neste caso, pode ser exigida ao proprietário a execução de medidas a isso apropriadas e a responsabilização pelos acontecimentos.

## Cabos de ligação aos aparelhos externos

Todos cabos de ligação devem apresentar condutores blindados. Em ambas as extremidades, o tecido de blindagem deve ser ligado em grande superfície com o corpo da ficha.

Outros cabos não devem ser estendidos em paralelo aos cabos de alimentação elétrica. Em casos em que a condução dos cabos em paralelo for inevitável deve ser mantida uma distância mínima de 0,5 m.

Gama de temperaturas dos cabos: -15 ... +80 °C.

Somente devem ser ligados aparelhos cujos circuitos elétricos obedecem aos requisitos da 'Safety Extra Low Voltage' (SELV). Em geral, estes aparelhos são verificados em conformidade com a EN 60950/EN 62368-1.

## Instalação dos cabos de dados

Os cabos de dados devem estar completamente blindados e estar equipados com fichas de conexão de metal ou metalizadas. Cabos e fichas blindados são necessários para evitar a emissão ou receção de interferências eletromagnéticas.

Cabos admissíveis

Cabo blindado:                    4 x 2 x 0,14 mm<sup>2</sup> ( 4 x 2 x AWG 26)  
    6 x 2 x 0,14 mm<sup>2</sup> ( 6 x 2 x AWG 26)  
    12 x 2 x 0,14 mm<sup>2</sup> (12 x 2 x AWG 26)

Os cabos de emissão e de receção devem ser respetivamente constituídos por pares entrelaçados.

Comprimento máximo dos cabos:        com interface V 24 (RS232C) - 3 m (com blindagem)  
    com interface paralela - 3 m (com blindagem)  
    com USB - 3 m  
    com Ethernet - 100 m

## Circulação de ar

Para evitar um aquecimento inadmissível deve existir uma circulação adequada de ar em torno do aparelho.

## Valores limite

Classe de proteção conforme IP:	20
Temperatura de ambiente °C (funcionamento):	mín. +5 máx. +35
Temperatura de ambiente °C (armazenagem):	mín. -20 máx. +60
Humidade relativa do ar % (funcionamento):	no máx. 80
Humidade relativa do ar % (armazenagem):	no máx. 80 (condensação no aparelho não permitida)

## Garantia

Não nos responsabilizamos por danos que possam ser causados por:

- Incumprimento dos requisitos operacionais ou das instruções de utilização
- Instalação elétrica local deficiente.
- Modificação construtiva dos nossos aparelhos.
- Programação ou utilização errada.
- Omissão da segurança de dados.
- Utilização de peças e acessórios não originais.
- Desgaste natural.

Ao preparar ou reprogramar aparelhos, deve verificar os ajustes novos através de um ensaio funcional ou uma impressão de teste. Desta forma evita resultados, marcas de impressão e análises deficientes.

Os aparelhos só podem ser utilizados por funcionários devidamente instruídos.

Controle o manuseamento correto dos nossos produtos e repita as ações de formação.

Não podemos garantir, que todas as características descritas nas presentes instruções se encontram implementadas em todos os modelos. Devido ao nosso esforço de um desenvolvimento e melhoramento contínuo, existe a possibilidade de alterações nas características técnicas, sem que estas sejam anunciadas.

Devido ao desenvolvimento ou prescrições nacionais específicas de cada país, as imagens e exemplos constantes nas instruções podem divergir do modelo fornecido.

Para evitar danos ou um desgaste prematuro, observe as informações sobre os meios de impressão admissíveis e as instruções sobre a conservação do aparelho.

Fizemos todos os esforços para editar este manual de forma compreensiva, e para lhe dar o máximo de informação possível. Em caso de dúvidas ou de encontrar erros, por favor informe-nos sobre o mesmo, para nos possibilitar o melhoramento dos nossos manuais.

## Desembalar a impressora de etiquetas

- ⇒ Levante a impressora de etiquetas pela parte inferior retirando-a do cartão.
- ⇒ Verifique a existência de eventuais danos de transporte.
- ⇒ Verifique se o fornecimento está completo.

### Conteúdo

- Impressora de etiquetas.
- Núcleo de fita de película (vazio), pré-montado sobre o enrolador de fita de transferência.
- Canto de corte (apenas nos aparelhos básicos).
- Régua de alimentação (apenas para aparelhos com opção de alimentador).
- Cabo de alimentação.
- Documentação.
- CD com controlador da impressora.
- Labelstar Office LITE.



#### AVISO!

Guarde a embalagem original para eventuais envios posteriores.

## Instalar a impressora de etiquetas



#### CUIDADO!

A humidade e água podem danificar o aparelho e os materiais de impressão.

- ⇒ Coloque a impressora de etiquetas apenas em locais secos e protegidos de água de salpico.
- ⇒ Instale a impressora num lugar plano e não sujeito a choques, vibrações e correntes de ar.
- ⇒ Abra a tampa da impressora de etiquetas.
- ⇒ Retire a espuma de proteção da zona da cabeça de impressão.

## Ligar a impressora de etiquetas

A impressora de etiquetas está equipada como uma fonte de alimentação variável. Esta pode ser operada com tensões de rede de 110 ... 230 V AC / 50-60 Hz sem qualquer intervenção no aparelho.



#### CUIDADO!

Perigo de danos no aparelho devido a correntes de arranque indefinidas.

- ⇒ Antes da ligação à rede, coloque o interruptor principal na posição '0'.
- ⇒ Insira o cabo de rede na tomada de alimentação.
- ⇒ Ligue o cabo de rede a uma tomada com ligação à terra.



#### AVISO!

Uma ligação à terra inexistente ou deficiente pode causar avarias durante o funcionamento. Certifique-se de que todos os computadores ligados à impressora de etiquetas, bem como os cabos de ligação, estão ligados à terra.

- ⇒ Ligue a impressora de etiquetas ao computador ou à rede utilizando um cabo adequado.

## Colocação em funcionamento a impressora de etiquetas

Depois de estabelecer todas as ligações:

- ⇒ Ligar a impressora de etiquetas no interruptor principal.  
Após o acionamento da impressora surge o menu inicial, no qual é indicado o tipo de impressora, a data e a hora atual.
- ⇒ Coloque o material de etiquetas e fita de transferência.
- ⇒ Inicie o processo de medição através da opção de menu *Disposição das etiquetas/Medir etiqueta*.
- ⇒ Ao premir o botão  no teclado de película, o processo de medição pode ser terminado.



#### AVISO!

De forma a garantir uma medição correta, devem ser avançadas no mínimo duas etiquetas completas (não no caso de etiquetas contínuas).

A medição das etiquetas e distâncias pode apresentar ligeiras diferenças. Por isso, os valores podem ser manualmente ajustados através da opção de menu *Disposição das etiquetas/Etiqueta e Fenda*.



## Colocar um rolo de etiquetas no modo de corte

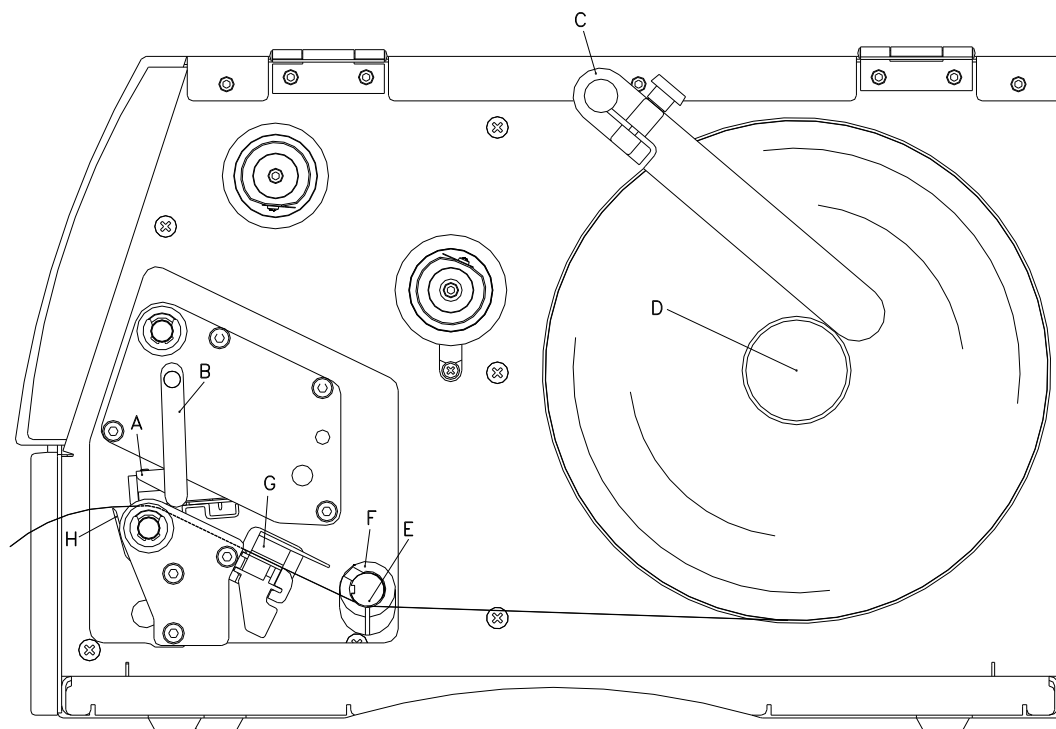

- Abra a tampa da impressora.
- Para destravar a cabeça de impressão (G), gire a alavanca vermelha de pressão (F) no sentido contrário ao dos ponteiros do relógio.
- Retire o suporte de etiquetas exterior (A).
- Coloque o rolo de etiquetas com enrolamento interior no dispositivo de desenrolamento (B) e volte a colocar o suporte de etiquetas (A).
- Introduza o material de etiquetas por baixo do veio de desvio (C) e da cabeça de impressão (G) e preste atenção para que o material circule através da barreira luminosa (E).
- Para encostar a cabeça de impressão (G), gire a alavanca vermelha de impressão (F) no sentido dos ponteiros do relógio, até encaixar.
- Em frente à cabeça de impressão vê-se um canto de corte (H).
- Introduzir o valor do Offset na opção de menu *Inicialização da impressora/Canto de corte*.
- Oriente os anéis de ajuste (D) do veio de desvio (C) à largura do material.
- Feche a tampa da impressora.

## Colocar uma fita de transferência



### AVISO!

Dado que a descarga eletrostática pode danificar a fina camada de revestimento da cabeça de impressão de transferência térmica ou outros componentes eletrônicos, a fita de transferência deverá ser do tipo anti-estático. A utilização de materiais errados pode causar mau funcionamento da impressora ou inviabilizar a garantia.

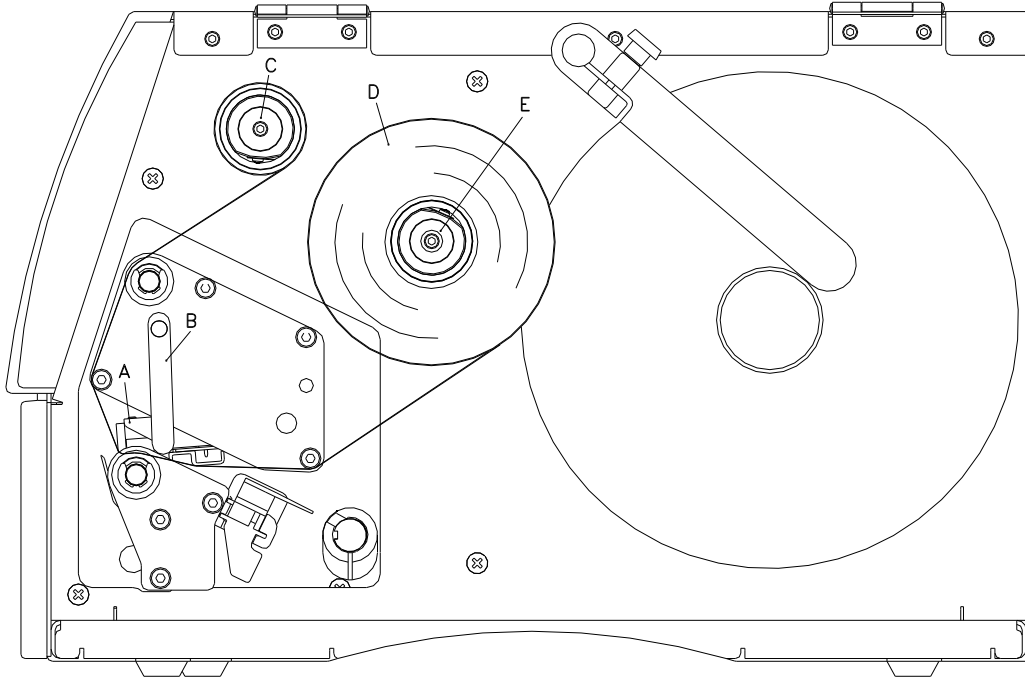

### AVISO!

Antes de colocar um rolo de fita de transferência novo, deve-se limpar a cabeça de impressão com agente de limpeza para cabeças de impressão e de tambores (97.20.002). Devem ser respeitadas as normas de manuseamento para utilização de Isopropanol (IPA). Em caso de contacto com a pele ou os olhos lavar bem sob água corrente. Em caso de irritações permanentes consultar o médico. Garantir uma boa ventilação.

- Abra a tampa da impressora.
- Abra a cabeça de pressão (E), no qual aperta a alavanca vermelha de pressão (D) contra o sentido do mostrador das horas.



### CUIDADO!

Existe o perigo de escoriações durante a colocação ou remoção da fita de transferência gasta!  
⇒ Preste atenção nas bordas da placa de mola!

- Coloque o rolo de transferência de fitas (B) com enrolamento exterior no rolo de desenrolamento (C). Preste atenção na colocação da fita a cores, para que o núcleo da fita a cores esteja fixo no encosto do rolo enrolador. De modo a obter uma boa impressão, a fita a cores não deve ser mais estreita que o material de etiquetas.
- Empurre um núcleo de esvaziamento de uma fita a cores (A) por cima do rolo enrolador. Conduza a fita de transferências por entre a cabeça de impressão (E).
- Fixe a fita através de uma fita adesiva no sentido de andamento ao núcleo de esvaziamento do rolo de enrolamento (A). De modo a testar um andamento impecável e sem falhas da fita de transferência, rode a manga de enrolamento várias vezes no sentido contrário ao do relógio.
- Para abrir a cabeça de impressão (E), rode a alavanca vermelha de pressão (D) no sentido dos ponteiros do relógio, até que engate.
- Feche a tampa da impressora.



### AVISO!

Dado que a descarga eletrostática pode danificar a fina camada de revestimento da cabeça de impressão de transferência térmica ou outros componentes eletrônicos, a fita de transferência deverá ser do tipo anti-estático. A utilização de materiais errados pode causar mau funcionamento da impressora ou inviabilizar a garantia.



### CUIDADO!

Influência do material estático no ser humano!

⇒ Utilizar uma fita de transferência antiestática, pois pode ocorrer descarga estática durante a remoção.

## Print Settings (Inicialização da impressão)

Sequência de teclas: , 

**Speed (Velocidade)** Introdução da velocidade em mm/s.  
Gama de valores: 50 mm/s ... 200 mm/s (consulte as Especificações técnicas).

**Contrast (Potência térmica)** Com a ajuda deste valor pode ser ajustada a intensidade da impressão em caso de utilização de materiais, velocidades ou conteúdos de impressão diferentes.  
Gama de valores: 10 % ... 200 %

Tecla: 

**Transfer ribbon control (Monitorização da fita de transferência)** Verificação se o rolo de fita de transferência terminou ou se a fita de transferência rasgou no rolo de desenrolamento.  
**Off (Desligado):** A monitorização da fita de transferência está desligada.  
**On, weak sensibility (Ligado, baixa sensibilidade):** A monitorização da fita de transferência está ligada. A impressora reage em cerca de 1/3 mais lenta ao fim da fita de transferência (default).  
**On, strong sensibility (Ligado, elevada sensibilidade):** A monitorização da fita de transferência está ligada. A impressora reage imediatamente ao chegar ao fim da fita de transferência.

Tecla: 

**Y displacement (Desvio Y)** Introdução do desvio do ponto zero expresso em mm.  
Gama de valores: -30.0 ... +90.0

Tecla: 

**X displacement (Desvio X)** Desvio da imagem geral de impressão no sentido transversal ao avanço do papel.  
Gama de valores: -90.0 ... +90.0

Tecla: 

**Tear off Offset (Canto de corte)** Indicação do valor a que é lançada para a frente a última etiqueta de uma tarefa de impressão, e, no início de nova impressão, o valor a que novamente é recolhida até ao início da etiqueta.  
Gama de valores: 0 ... 50,0 mm.  
Padrão: 12 mm.

## Label Layout (Disposição das etiquetas)

Sequência de teclas: , , 

**Label length (Altura da etiqueta)** Indicação da altura da etiqueta em mm.  
Altura mínima recomendada: 5 mm (alimentador 25 mm).

**Gap length (Distância de intervalo)** Indicação da distância entre duas etiquetas em mm.  
Valor mínimo recomendado: 1 mm

Tecla: 

**Column printing (Largura de impressão)** Indicação da largura de uma etiqueta, bem como a indicação da quantidade das etiquetas que se encontram lado a lado no material de suporte.

Tecla: 

**Measure label (Medir etiqueta)** Iniciar o processo de medição com o botão .

Tecla: 

**Label type (Tipo de etiquetas)** Por norma encontram-se ajustadas as etiquetas auto-adesivas, porém, se desejar utilizar etiquetas contínuas, deverá premir o botão .

Tecla: 

**Material selection (Escolha do material)** Escolha do material das etiquetas ou do material da fita de transferência.

Tecla: 

**Photocell (Célula fotoelétrica)** Seleção da célula fotoelétrica utilizada.  
Estão disponíveis as seguintes opções: Células fotoelétricas de passagem normal e invertida, de reflexão normal e invertida, células ultra-sónicas (opcional).

**Scan position - SP (Posição de procura - PP)** Com ajuda desta função pode ser introduzido o comprimento percentual da etiqueta, após ter sido localizada a extremidade da mesma.

Tecla: **Label error length  
(Comprimento de falha  
das etiquetas)**

Indica após quantos mm, em caso de avaria, deve surgir uma mensagem no visor.  
Gama de valores: 1 ... 999 mm

**Synchronization  
(Sincronização)**

**On (Ligado):** No caso de faltar uma etiqueta no material de suporte é visualizada uma mensagem de erro.  
**Off (Desligado):** A falta de etiquetas é ignorada, ou seja, é impresso sobre o espaço vazio.

Tecla: **Flip label  
(Espelhar etiqueta)**

O eixo de espelhamento encontra-se no centro da etiqueta. Quanto não tiver sido transmitida a largura da etiqueta à impressora, é utilizada a largura de etiqueta padrão, ou seja, a largura da cabeça de impressão. Por isso deve ter em consideração, que a etiqueta tenha a largura da cabeça de impressão. Caso contrário podem ocorrer problemas durante o posicionamento.

Tecla: **Rotate label  
(Rodar etiqueta)**

Por defeito, a etiqueta é devidamente impressa saindo primeiro a parte de cima com uma rotação de 0°. Se a função estiver ativada, a etiqueta é girada 180° e impressa no sentido de leitura.

Tecla: **Rotate label in degrees  
(Rodar etiqueta em graus)**

De acordo com o parâmetro *rodar a etiqueta*, pode a etiqueta ser rodada em etapas de 90°.

**AVISO!**

Somente podem ser girados os objetos internos da impressora (textos, linhas e códigos de barras). A rotação de gráficos não é possível.

Tecla: **Alignment  
(Alinhamento)**

O alinhamento da etiqueta apenas se dá depois de se rodar/espelhar, ou seja, o alinhamento depende da rotação e do espelhamento.

**Left (Esquerda):** A etiqueta é alinhada na margem esquerda da cabeça de impressão.

**Centre (Centro):** A etiqueta é alinhada no ponto central da cabeça de impressão (centrada).

**Right (Direita):** A etiqueta é alinhada na margem direita da cabeça de impressão.

**Device Settings (Parâmetros do aparelho)**Sequência de teclas:    **Field handling  
(Gestão de memória)**

**Off (Desligado):** Toda a memória de impressão será apagada.

**Keep graphic (Conservar o gráfico):** Um gráfico ou um tipo de letra TrueType será transferido uma vez para a impressora e guardado na memória interna da impressora. Para as tarefas seguintes de impressão já só serão transferidos para a impressora os dados alterados. A vantagem é a poupança no tempo de transmissão dos dados gráficos.

**Delete graphic (Eliminar o gráfico):** Os gráficos introduzidos na memória interna da impressora ou tipos de letra TrueType serão apagados, os campos restantes serão, no entanto, mantidos.

**Restore graphic (Restaurar gráfico):** no final de um trabalho de impressão, o trabalho impresso pode ser reiniciado na impressora. Todos os gráficos e tipos de letras TrueType serão reimpressos.

**AVISO!**

**Exceção:** Para impressão em várias faixas, devem ser impressas as faixas completas (quantidade sempre múltipla das faixas). As faixas excluídas não serão restauradas.

Tecla: **Codepage  
(Codepage)**

Escolha do conjunto de caracteres a utilizar. Estão disponíveis as seguintes opções:













Codepage 437, Codepage 850, Codepage 852, Codepage 857, Codepage 1250, Codepage 1251, Codepage 1252, Codepage 1253, Codepage 1254, Codepage 1257, WGL4. Pode encontrar a tabela com os conjuntos de caracteres mencionados na nossa página principal.

Tecla: **External parameters  
(Parâmetro exterior)**

**Label dimension only (Apenas dimensão da etiqueta):** Os parâmetros do comprimento da etiqueta, espaço entre etiquetas e largura da etiqueta podem ser transferidos. Todas as outras configurações de parâmetros devem ser efetuadas diretamente na impressora.

**On (Ligado):** Os parâmetros podem ser transferidos para a impressora pelo nosso software de configuração de etiquetas. Os parâmetros que antes tinham sido diretamente introduzidos na impressora, não voltarão a ser tidos em conta.

**Off (Desligado):** Apenas serão consideradas as definições ajustadas diretamente na impressora.

Tecla: 	
<b>Buzzer</b> (Sinalizador acústico)	<b>On (Ligado):</b> Um sinal acústico é emitido ao premir qualquer botão. Gama de valores: 1 ... 7 <b>Off (Desligado):</b> Não se houve qualquer sinal.
<b>Display</b> (Visor)	Ajuste do contraste no visor. Gama de valores: 45 ... 75
Tecla: 	
<b>Language</b> (Idioma)	Escolha do idioma no qual os textos devem surgir no visor da impressora. Estão disponíveis as seguintes opções: alemão, inglês, francês, espanhol, finlandês, checo, português, neerlandês, italiano, dinamarquês, polaco, grego, húngaro, russo, chinês (opção), ucraniana, turco, sueco, norueguês, estoniano.
Tecla: 	
<b>Keyboard</b> (Atribuição de botões)	Seleção do esquema regional para a atribuição dos botões desejada. Estão disponíveis as seguintes opções: Selecionar Alemanha, Inglaterra, França, Grécia, Espanha, Suécia, EUA e Rússia.
Tecla: 	
<b>Customized entry</b> (Introdução do Utilizador)	<b>Off (Desligado):</b> No ecrã não aparece qualquer solicitação das variáveis de utilizador. Neste caso é impresso o valor predefinido guardado. <b>On (Ligado):</b> A consulta pelas variáveis de utilizador aparece uma vez no visor antes de iniciar a impressão. <b>Auto (Automático):</b> as consultas pelas variáveis guiadas pelo utilizador e o número de unidades surgem depois de cada layout. <b>Auto without quantity query (Automático sem consulta de números de unidades):</b> a consulta pelas variáveis guiadas pelo utilizador surge depois de cada layout sem consulta adicional do número de unidades.
Tecla: 	
<b>Hotstart</b> (Arranque a quente)	<b>On (Ligado):</b> Uma tarefa de impressão pode ser retomada depois de voltar a ligar a impressora. <b>Off (Desligado):</b> Todos os dados serão perdidos depois de desligar a impressora.
Tecla: 	
<b>Autoload</b> (Carregamento automático)	<b>On (Ligado):</b> Uma etiqueta que tenha sido carregada do cartão Compact Flash uma vez, pode voltar a ser carregada automaticamente após um reinício da impressora. Após o reinício da impressora é sempre carregada a etiqueta que tinha sido carregada do cartão Compact Flash em último lugar. <b>Off (Desligado):</b> Após um reinício da impressora tem de voltar a carregar-se manualmente do cartão Compact Flash a última etiqueta utilizada. Não é possível uma utilização simultânea das funções de carregamento automático e do arranque a quente.
Tecla: 	
<b>Manual reprint</b> (Reimpressão manual)	<b>Yes (Sim):</b> Se a impressora estiver no modo parado, p. ex. devido ao aparecimento de um erro, pode voltar a imprimir a última etiqueta imprimida com a ajuda dos botões  e  .
Tecla: 	<b>No (Não):</b> Apenas serão avançadas etiquetas vazias.
<b>Backfeed/Delay</b> (Retirada/Retardamento)	<b>Backfeed (Retirada):</b> O cancelamento dos modos de operação Alimentador (opcional) e Lâmina (opcional) foi otimizada de forma que, ao entrar no offset, a etiqueta seguinte já será, se possível, parcialmente impressa, e desta forma eliminada a recolha da etiqueta, podendo desta forma poupar-se tempo. <b>Delay (Retardamento):</b> O tempo de retardamento ajustável apenas tem importância para o modo de funcionamento de <i>Retirada automática</i> .
Tecla: 	
<b>Confirm label change</b> (Confirmação da etiqueta)	<b>On (Ligado):</b> Apenas é impressa uma nova tarefa de impressão após confirmação no aparelho. Uma tarefa de impressão contínua já ativa continua a ser impressa até que seja feita a confirmação no aparelho. <b>Off (Desligado):</b> Não aparece qualquer consulta no visor do acionamento.
Tecla: 	
<b>Standard label</b> (Disposição etiqueta)	<b>On (Ligado):</b> Se for iniciada uma tarefa de impressão sem que haja a definição prévia de uma etiqueta será impressa uma etiqueta padrão (tipo de equipamento, versão do Firmware, versão da compilação). <b>Off (Desligado):</b> Se for iniciada uma tarefa de impressão sem que haja a definição prévia de uma etiqueta, irá aparecer uma mensagem de erro no visor.

Tecla: **Synchronization at switching on (Sincronização ao ligar)**

**Off (Desligado):** A sincronização está desativada, isto é, o processo de medição e o avanço de etiquetas devem ser acionados manualmente.

**Measure (Medição):** Depois de ligar o módulo de impressão a etiqueta inserida é logo medida.

**Label feed (Avanço de etiqueta):** Depois de ligar a impressora, a etiqueta é sincronizada no início da etiqueta. Para isso, são introduzidas uma ou mais etiquetas.

Tecla: **CMI length (Comprimento CMI)**

Se a impressão da etiqueta for interrompida, pode na cabeça da impressora, surgir uma interrupção na imagem impressa, em que se vê uma linha branca fina na etiqueta. Para evitar isso, pode ser ajustado um valor mínimo para a retirada (0–1 mm), onde o material da etiqueta é puxado. Na próxima impressão o espaço livre em branco será impresso. O ajuste do comprimento do CMI só tem efeito na escolha da retirada do modo ótima.

**Network (Rede)**Sequência de teclas: , , , , , 

Para obter mais informações, consulte o manual em separado.

**Password (Palavra-chave)**Sequência de teclas: , , , , , **Operation (Operação)****Password (Palavra-chave)**

Introdução de uma palavra-chave de 4 dígitos.

Tecla: **Protection configuration (Menu da função da proteção da palavra-chave)**

Configurações da impressora podem ser alteradas (força da queima, velocidade, tipo de operação...). A proteção da palavra-chave impede modificações na configuração da impressora.

Tecla: **Protection favorites (Palavra-chave favoritos)**

A proteção da palavra-chave impede o acesso ao menu favoritos.

Tecla: **Protection memory card (Cartão de memória para a proteção da palavra-chave)**

Com as funções do cartão de memória podem ser gravadas, carregadas etiquetas... A proteção da palavra-chave tem de distinguir se não são autorizados nenhuns acessos ou somente os acessos legíveis do cartão de memória.

**Acesso completo:** Sem proteção da palavra-chave

**Somente leitura:** Só é possível acessos legíveis

**Protegido:** Acessos bloqueados

Tecla: **Protection printing (Proteção da palavra-chave na impressora)**

Se a impressora está ligada a um PC, pode ser útil, se o operador não acionar a impressão manual. A proteção da palavra-chave impede o acionamento manual da impressão.

**Network (Rede)****Password (Palavra-chave)**

Introdução de uma palavra-chave com 15 dígitos. A introdução pode ser alfanumérica e com caracteres especiais.

Tecla: **Protection HTTP (Proteção da palavra-chave HTTP)**

A comunicação através do http pode ser impedida.

Tecla: **Protection Telnet (Proteção da palavra-chave Telnet)**

A configuração do serviço Telnet não pode ser alterada.

Tecla: 

**Protection remote access** (Proteção da palavra-chave acesso remoto) Acesso, através do interface externo HMI, pode ser impedido.

**AVISO!**

Para poder realizar uma função bloqueada, primeiro terá de ser dada a palavra-chave válida. Se a palavra-chave é correta, então a função desejada pode ser realizada.

**Interface (Interfaces)**Sequência de teclas: , , , , , , , **COM1 / Baud / P / D / S****COM1:**

0 - Interface de série desligada  
1 - Interface de série ligada  
2 - Interface de série ligada; não será mostrada qualquer mensagem de erro numa falha de transmissão

**Baud (Baud):**

Indicação dos bits transferidos por segundo. Os seguintes valores podem ser escolhidos: 2400, 4800, 9600, 19200, 38400, 57600 e 115200.

**P = Parity (Paridade):**

N - sem paridade (no parity); E - par (even); O - ímpar (odd)  
Deverá ter em atenção para que os ajustes estejam de acordo com os da impressora.

**D = Data bits (Bits de dados):**

Ajuste dos bits de dados. Pode escolher entre 7 ou 8 bits.

**S = Stop bit (Bits de paragem):**

Tem a possibilidade de escolher entre 1 ou 2 bits de paragem.  
Indicação dos bits de paragem entre os bytes.

Tecla: 

**Start/stop sign** (Sinal de Início/ Paragem)



**SOH:** Início do bloco de transmissão de dados → Formato HEX 01**ETB:** Fim do bloco de dados por transmitir → Formato HEX 17Tecla: 

**Data memory** (Memória de dados)

**Standard (Padrão):** Depois de iniciar uma tarefa de impressão, os dados serão recebidos até a memória temporária de impressão ficar cheia.**Advanced (Expandido):** Durante uma tarefa de impressão em curso continua a receção e o processamento de dados.**Off (Desligado):** Depois de iniciar uma tarefa de impressão não são recebidos mais dados.Tecla: 

**Port test** (Teste do portal)



Verificação se os dados são transmitidos através da interface.

Premir a tecla  e  para selecionar Geral (On). Premir a tecla  e os dados que são enviados através de uma porta à escolha (COM1, LPT, USB, TCP/IP) são impressos.

**Emulation (Simulação)**Sequência de teclas: , , , , , , , , 

**Protocol** (Protocolo)

**CVPL:** Carl Valentin Programming Language**ZPL:** Zebra® Programming Language

Selecionar o protocolo com as teclas  e . Premir a tecla  para confirmar a seleção. A impressora é reiniciada e os comandos ZPL II® são convertidos internamente em comandos CVPL.

Tecla: 

**Printhead resolution** (Resolução da cabeça de impressão)

Caso esteja ativada a simulação com ZPL II® deverá configurar-se a resolução da cabeça de impressão da impressora para a qual se está a fazer a simulação.

**AVISO!**

Se a resolução da cabeça de impressão da impressora Zebra® divergir da resolução do aparelho Valentin, o tamanho dos objetos (por ex. textos, gráficos) não correspondem.

Tecla: **Drive mapping  
(Atribuição da drive)**

O acesso a drives Zebra® é convertido para drives Valentin correspondentes.





**AVISO!**

Uma vez que os fontes contidos nos impressoras Zebra® não estão disponíveis nos aparelhos Valentin, podem surgir ligeiras diferenças no aspeto da impressão.

Tecla: **PJL – Printer Job  
Language  
(PJL – Linguagem do  
trabalho à impressora)**

Podem ser indicadas no trabalho a imprimir as informações do estado correspondentes.

**Date & Time (Data & Hora)**Sequência de teclas: , , , , , , , , , , , **Set date and time  
(Alteração da data e da  
hora)**

A linha superior do visor indica a data atual, a linha inferior a hora atual. Com os botões  e  pode aceder ao campo seguinte e aumentar ou diminuir os valores apresentados utilizando os botões  e .

Tecla: **Summertime  
(Hora de Verão (HV))**

**Ligado:** A impressora comuta automaticamente para a hora de Verão ou hora de Inverno.  
**Desligado:** A hora de Verão não é automaticamente detetada e alterada.

Tecla: **Start of summertime -  
format  
(Início da hora de Verão –  
Formato)**

Seleção do formato para introduzir o início da hora de Verão.  
DD = Dia  
WW = Semana  
WD = Dia da semana  
MM = Mês  
YY = Ano  
next day = apenas o próximo dia é considerado

Tecla: **Start of summertime - date  
(Início da hora de Verão –  
Data)**

A introdução da data de quando a hora de verão deve começar. Esta introdução refere-se ao formato anteriormente selecionado.

Tecla: **Start of summertime - time  
(Início da hora de Verão –  
Hora)**

Através desta função pode introduzir a hora de início da hora de Verão.

Tecla: **End of summertime -  
format  
(Final da hora de Verão –  
Formato)**

Seleção do formato para introduzir o final da hora de Verão.

Tecla: **End of summertime - date  
(Final da hora de Verão –  
Data)**

Introdução da data de fim da hora de Verão. A introdução refere-se ao formato anteriormente selecionado.

Tecla: **End of summertime - time  
(Final da hora de Verão –  
Hora)**

Introdução da hora do fim da hora de Verão.

Tecla: **Time shifting  
(Mudança da hora)**

Introdução da mudança de hora, expressa em horas e minutos, para a hora de Verão/Inverno.



## Service Functions (Funções de serviço)



### AVISO!

De modo a que o distribuidor ou o fabricante possa prestar um serviço de apoio rápido, a impressora dispõe de um menu funções de serviço.

Informações necessárias, como por exemplo, as dos parâmetros introduzidos, podem ser consultadas diretamente na impressora.

Outras indicações como por exemplo Firmware ou versão do tipo de letra podem ser obtidas do menu inicial.

Sequência de teclas: **F**, , , , , , , , , , 

#### Label parameters (Parâmetros das etiquetas)

Indicação dos parâmetros de etiquetas em Volt.

**A:** O valor mínimo será indicado.

**B:** O valor máximo será indicado.

**C:** É apresentado o valor limite para a comutação. Este é determinado através da medição e pode ser alterado.

Tecla: 

#### Photocell configuration (Definições das células fotoelétricas)

Esta função permite a definição dos níveis de potência das células fotoelétricas.

Os níveis para as células fotoelétricas podem ser manualmente ajustadas caso haja problemas com o posicionamento ou a medição das etiquetas. Tenha o cuidado de definir uma elevação grande (para etiquetas >3 V, para o espaço <1 V).

Tecla: 

#### Photocell parameters (Parâmetros das células fotoelétricas)

**DLS:** Indicação do nível da célula fotoelétrica de passagem em Volt.

**RLS:** Indicação do nível da célula fotoelétrica de reflexão em Volt.

**SLS:** Indicação do nível da célula fotoelétrica da alimentação em Volt.

**TR:** Indicação do estado da célula fotoelétrica da fita de transferência (0 ou 1).

**H:** Indicação dos valores 0 ou 1 para a posição da cabeça de pressão.

0 = Cabeça de impressão em baixo

1 = Cabeça de impressão em cima

Tecla: 

#### Paper counter (Capacidade)

**D:** Indicação da capacidade de rendimento da cabeça de impressão, expressa em metros.

**G:** Introdução da capacidade de rendimento do aparelho, expressa em metros.

Botão: 

#### Heater resistance (Dot-Resistência)

De modo a atingir uma boa imagem de impressão, em caso de troca da cabeça de impressão, deverão ser ajustados os valores de Ohm indicados na cabeça de impressão.

Botão: 

#### Printhead temperature (Temperatura das cabeças de impressão)

Indicação da temperatura das cabeças de impressão. A temperatura da cabeça de impressão está, normalmente, à temperatura ambiente. Se a temperatura máxima da cabeça de impressão, no entanto, for excedida, a tarefa de impressão em curso é cancelada e é mostrada uma mensagem de erro no visor da impressora.

Tecla: 

#### Motor ramp Motor Rampa

Quanto mais elevado for introduzido o valor '++', mais lento será a aceleração do motor de avanço. Quanto mais reduzido for introduzido o valor '--', mais rapidamente será travado o motor de avanço.

Tecla: 

#### Print examples (Exemplos de impressão)

Ao ativar este ponto do menu obterá uma impressão com diversos ajustes do módulo de impressão.

**Settings (Relatório de estado):** São apresentadas todas as definições do módulo, por ex. velocidade, o material das etiquetas, o material das fitas de transferência etc.

**Bar codes (Códigos de barras):** São impressos todos os códigos de barras disponíveis.

**Fonts (Fontes):** São mostradas todas as fontes em formato bitmap e vetorial.

Tecla: 

#### Input (Input)

Indicação dos níveis para entradas.

0 = Low (baixo)

1 = High (alto)

Tecla: 

#### Output (Output)

Indicação dos níveis para saídas.

0 = Low (baixo)

1 = High (alto)

Tecla: **I/O status  
(Estado E/S)**

Os eventos relevantes são contados e registados na memória RAM. Após desligar o aparelho, o protocolo é apagado.

**RInt** = Real Interrupts

Conta os impulsos da entrada de partida diretamente no Interrupt.

**Dbnc** = Debounced

Conta os impulsos da entrada de partida mais longos que o tempo de purificação definido. Apenas esses impulsos de partida podem conduzir a uma impressão. Caso um impulso de partida seja demasiado curto, não aciona qualquer impressão. Aí é detetado que RInt conta, Dbnc não.

**NPrn** = Not Printed

Conta os impulsos da entrada de partida depurados que não conduziram a uma impressão.

Causas para isso: Nenhum pedido de impressão ativo, pedido de impressão foi parado (manual ou devido a um erro) ou o sistema de impressão ainda está ativo com o processamento de um pedido de impressão.

**PrtStrtReset** = Repõe todos os contadores.

**PrtStrtTime** = Comprimento medido do último impulso de partida em ms.

Tecla: **Cutter photocell  
(Lâmina de célula  
fotoelétrica)**

1 = A impressora está equipada com uma lâmina.

0 = A impressora não está equipada com uma lâmina.

**Cutter Home (CH)**

1 = A lâmina encontra-se na posição base e dessa forma está preparada para cortar.

0 = A lâmina ainda não se encontra-se na posição inicial, mas deve ser colocada na mesma antes de poder ativar o processo de corte.

Tecla: **Online/Offline  
(Online/Offline)**

Se esta função estiver ativada poderá selecionar-se entre o modo on-line e o modo offline com a tecla  (Padrão = Desligada).

**Online:** É possível receber dados através das interfaces. Os botões do teclado apenas se encontram ativas caso se tenha mudado para o modo offline com o botão .

**Offline:** Os botões do teclado encontram-se de novo ativos, mas as informações recebidas já não são processadas. Quando o aparelho voltar a estar no modo online voltarão a ser recebidas novas tarefas de impressão.

Tecla: **Transfer ribbon warning  
(Pré-aviso de fita de  
transferência)**

**TRB = Transfer ribbon advance warning (Pré-aviso de fita de transferência):**

É emitido um sinal por uma saída de comando antes do fim da fita de transferência.

**Warning diameter (Diâmetro de pré-aviso):**

Ajuste do diâmetro de pré-aviso da fita de transferência.

Se neste ponto for apresentado um valor em mm, quando se alcançar esse diâmetro (medido na fita de transferência) é dado um sinal por meio de uma saída de controlo.

**Ribbon advance warning mode (Modo de funcionamento para pré-aviso):**

**Warning (Aviso):** Ao atingir o diâmetro de pré-aviso, é definida a respetiva saída I/O.

**Reduced print speed (Velocidade reduzida):** A velocidade deve ser reduzida para a velocidade de impressão.

**Error (Erro):** O sistema de impressão fica parado ao atingir o diâmetro de pré-aviso com «pouca fita de transferência».

**Reduced print speed (Velocidade reduzida):**

Configuração da velocidade de impressão reduzida em mm/s. Esta pode ser definida nos limites da velocidade de impressão normal.

Tecla: **Zero point adjustment  
in Y direction  
(Desvio do ponto zero na  
direção Y)**

A introdução do valor é feita em 1/100 mm.

Caso, após a substituição da cabeça de impressão, a impressão não seja retomada no mesmo ponto da etiqueta, esta diferença pode ser corrigida na direção da impressão.

**AVISO!**

O valor para o ajuste do ponto neutro é definido ainda na fábrica e apenas pode voltar a ser ajustado aquando da substituição da cabeça de impressão, por parte de pessoal da assistência.

Tecla: **Zero point adjustment  
in X direction  
(Desvio do ponto zero na  
direção X)**

A introdução do valor é feita em 1/100 mm.  
Caso, após a substituição da cabeça de impressão, a impressão não seja retomada no mesmo ponto da etiqueta, esta diferença pode ser corrigida na transversal relativamente à direção da impressão.

**AVISO!**

O valor para o ajuste do ponto neutro é definido ainda na fábrica e apenas pode voltar a ser ajustado aquando da substituição da cabeça de impressão, por parte de pessoal da assistência.

Tecla: **Comprimento de  
impressão +/-**

Ajuste da correção da imagem de impressão em %.  
Mediante influências mecânicas (por ex. tamanho do rolo), é possível imprimir a imagem de impressão com dimensões maiores ou menores em relação ao tamanho original.  
Gama de valores: +10.0 % ... -10.0 %

Tecla: **Write log files on MC  
(Ficheiros LOG escritos  
num MC)**

Através deste comando serão escritas diferentes ficheiros LOG num meio de armazenamento existente (cartão MC). Depois da mensagem "terminado", o meio de armazenamento pode ser retirado.

Os ficheiros encontram-se no índice "LOG":

**LogMemErr.txt:** Erros em protocolo com informações adicionais, tais como Data/Hora e nome do ficheiro / nº de linha (para os desenvolvedores)

**LogMemStd.txt:** Eventos escolhidos em protocolo

**LogMemNet.txt:** Os últimos dados enviados através do Port 9100

**Parameters.log:** Todos os parâmetros em forma legível

**TaskStatus.txt:** O estado de todos os trabalhos da impressora



















**Main Menu (Menu inicial)**

Após a entrada em funcionamento da impressora de etiquetas é apresentado o menu inicial. O menu inicial mostra informações, tais como: o tipo de impressora, data e hora atuais, número da versão do firmware e os FPGA usados. O item selecionado é apresentado por pouco tempo e, depois, volta novamente à primeira informação.

Com a tecla  pode aceder ao próximo item.

## Compact Flash Card / Unidade Flash USB\*

O menu de memória é operado através dos botões do teclado da impressora de etiquetas ou com as diversas teclas de funções de um teclado USB.

		Retroceder para o último menu.
		Na função <i>Load layout</i> (Carregar esquema): Mudar para o Explorador de Ficheiros. File Explorer: Mudar para o Menu de Contexto (context menu).
		Marcar um ficheiro/um diretório assim que for possível uma seleção múltipla.
		Menu inicial: Seleção do menu de memória. Explorador de Ficheiros: Criar um ficheiro novo.
		Executar uma função atual para o ficheiro atual/diretório atual.
		Mudar para o diretório principal.
		Mudar para o diretório atualmente marcado.
		No diretório deslocar para cima.
		No diretório atual deslocar para baixo.

### Define user directory (Definir diretório de utilizador)

Define o diretório padrão onde são guardados os ficheiros para processamento.



#### AVISO!

É necessário definir um diretório de utilizador:

- antes de utilizar ou navegar no menu de memória.
- se tiver sido realizada a formatação do cartão CF no PC e, assim, o diretório PADRÃO não tiver sido automaticamente criado.

```
File Explorer
A:\
[Drives]
-><STANDARD>
<DIR_1>
```

```
Context Menu
A:
->Set as user dir
Format
Copy
```



Acesso ao menu de memória.



Aceder ao Explorador de ficheiros.



Selecionar diretório.



Indicação das funções disponíveis



Selecionar função *Set as user dir* (como diretório de utilizador)



Confirmar seleção.



Regressar ao menu base.

No próximo acesso ao menu de memória, o diretório selecionado é indicado como diretório de utilizador.

### Load layout (Carregar o esquema)

```
Load layout
A:\STANDARD
->File_name1.prn
File_name2.prn
File_name3.prn
File_name4.prn
```



Acesso ao menu de memória.



Selecionar o esquema.



Confirmar seleção.

A janela para introdução do número de unidades é automaticamente exibida.



Selecionar a quantidade do esquema que devem ser impressos.



Iniciar a tarefa de impressão.



#### AVISO!

O diretório NÃO pode ser alterado aqui. Uma mudança de diretório DEVE ser executado no Explorador de Ficheiros com a função *Change directory* (Mudar diretório).

\* não disponíveis

## File Explorer

O File Explorer é o sistema de gestão de ficheiros do sistema de impressão. As principais funções para a interface do menu de memória são disponibilizadas no File Explorer.

Na vista do diretório de utilizador, ao premir a tecla **F** acede ao File Explorer.

Podem ser selecionadas as seguintes funções:





- Substituir a drive ou o diretório
- Carregar ficheiro
- Guardar esquema ou configuração
- Eliminar ficheiro(s)
- Formatar cartão CF
- Copiar ficheiro(s)

## Change directory (Mudar diretório)

```
File Explorer
A:\
[Drives]
-><STANDARD>
<DIR_1>

File Explorer
A:\STANDARD\
-><..>
  layout01
  layout02
```





Seleção da drive ou do diretório no qual os ficheiros estão guardados.

-  Acesso ao menu de memória.
-  Aceder ao Explorador de ficheiros.
-  Seleccionar diretório.
-  Confirmar seleção.  
O diretório selecionado é indicado.

## Load file (Carregar o ficheiro)

```
Load file
A:\STANDARD\
<..>
->layout01
  layout02
```

Carrega um ficheiro qualquer. Este pode ser uma configuração anteriormente memorizada, um esquema, etc.

-  Acesso ao menu de memória.
-  Aceder ao Explorador de ficheiros.
-  Seleccionar o ficheiro.
-  O ficheiro selecionado é carregado.







### AVISO!

No caso do ficheiro selecionado, caso se trate de um layout, a quantidade de cópias a imprimir pode ser introduzida de imediato.

## Save layout (Memorizar o esquema)

```
Save file
A:\STANDARD
->Save layout
  Save config.
  noname
```

Protege o layout atualmente carregado com o nome selecionado.



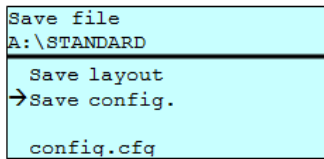

-  Acesso ao menu de memória.
-  Aceder ao Explorador de ficheiros.
-  Mudar para o menu *Save file* (Guardar ficheiro).
-  Seleccionar a função *Save layout* (Guardar o esquema).
-  Confirmar seleção.

Se estiver ligado um teclado USB, pode ser atribuído um novo nome de ficheiro para *noname*.

**Save configuration  
(Memorizar a configuração)**



Protege a configuração atual completa do sistema de impressão direta com o nome seleccionado.





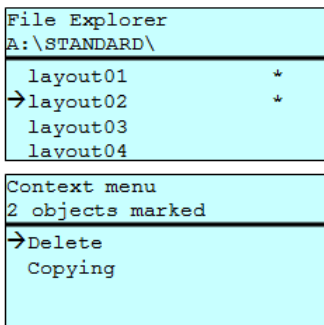

-  Acesso ao menu de memória.
-  Aceder ao Explorador de ficheiros.
-  Mudar para o menu *Save file* (Guardar ficheiro).
-  Selecionar a função *Save configuration* (Memorizar configuração).
-  Confirmar seleção.

Se estiver ligado um teclado USB, pode ser atribuído um novo nome de ficheiro para *config.cfg*.

**Delete file  
(Eliminar ficheiros)**



Elimina irrevogavelmente um ou vários ficheiros ou directórios. Ao eliminar um directório são eliminados os ficheiros contidos como também os subdirectórios.

-  Acesso ao menu de memória.
-  Aceder ao Explorador de ficheiros.
-  Selecionar o ficheiro.
-  Marcar os ficheiros que devem ser eliminados. As entradas marcadas são identificadas com \*. Executar este processo até que todos os ficheiros ou directórios pretendidos estejam marcados para eliminar.
-  Mudar para o menu de contexto.
-  Selecionar a função *Delete* (Eliminar).
-  Confirmar seleção.

**Formatting  
(Formatar)**







Formata irrevogavelmente um cartão de memória.

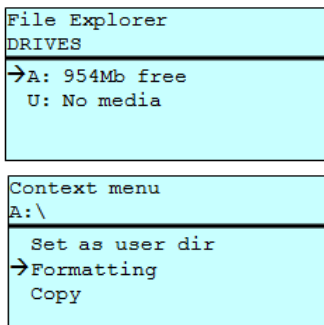

**AVISO!**

Os sticks USB não podem ser formatados no módulo de impressão direta!



-  Acesso ao menu de memória.
-  Aceder ao Explorador de ficheiros.
-  Selecionar a unidade que deve ser formatada.
-  Mudar para o menu de contexto (context menu).
-  Selecionar a função *Formatting* (Formatar).
-  Confirmar seleção.

### Copying (Copiar)

```
File Explorer
A:\STANDARD\
layout01 *
→ layout02 *
layout03
layout04
```

```
Context menu
2 objects marked
Delete
→ Copying
```

```
Select Destination
DRIVES
→ A: 954Mb free
```

Cria um duplicado do ficheiro original ou do diretório original para poder executar, em seguida, alterações independentemente do original.



Acesso ao menu de memória.



Aceder ao Explorador de ficheiros.



Selecionar o ficheiro.



Marcar os ficheiros que devem ser copiados. As entradas marcadas são identificadas com \*. Executar este processo até que todos os ficheiros ou diretórios pretendidos estejam marcados para copiar.



Mudar para o menu de contexto (context menu).



Selecionar a função *Copying* (Copiar).



Determinar o destino do processo de cópia.



Selecionar a localização de destino de armazenamento.



Confirmar seleção.

### Filtro:

#### Apenas possível com ligação a um teclado USB.

Caso esteja ligado um teclado USB, pode ser indicado uma máscara de filtro ou um nome de ficheiro de um ficheiro a memorizar. Esta introdução é apresentada no caminho. Com a máscara de filtro é possível procurar determinados ficheiros. Durante a introdução de "L" são apresentadas por exemplo apenas ficheiros que começam com a cadeia "L" (maiúsculas/minúsculas não são consideradas).

#### Sem filtro

```
Load layout
A:\STANDARD
→ First_file.prn
Layout_new.prn
Sample.prn
12807765.prn
```

#### Com filtro

```
Load layout
L
→ Layout_new.prn
```

## Especificações técnicas

	Vita II 103/8 T	Vita II 104/8	Vita II 106/12	Vita II 106/24	Vita II 108/12 T
Resolução	203 dpi	203 dpi	300 dpi	600 dpi	600 dpi
Velocidade de impressão máx.	200 mm/s	200 mm/s	150 mm/s	100 mm/s	150 mm/s
Largura de impressão	104 mm	104 mm	105,7 mm	105,7 mm	108,4 mm
Largura de passagem					
Padrão	116 mm	116 mm	116 mm	116 mm	116 mm
Lâmina	112 mm	112 mm	112 mm	112 mm	112 mm
Cabeça de impressão	Flat Type <sup>1</sup>	Flat Type <sup>2</sup>	Flat Type <sup>2</sup>	Flat Type <sup>2</sup>	Flat Type <sup>1</sup>
<b>Etiquetas</b>					
Material de etiquetas ou contínuo em rolo ou zig-zag	Papel, cartolina, têxtil, plástico				
Espessura do material	máx. 220 g/m <sup>2</sup> (maior à consulta)				
Largura mínima para etiquetas	12 mm				
Altura mínima para etiquetas					
Padrão	5 mm				
Lâmina ou alimentador	15 mm				
Altura máx. das etiquetas	6000 mm	6000 mm	3000 mm	1000 mm	3000 mm
Diâmetro máx. dos rolos					
Desenrolamento interno	180 mm				
Enrolamento interno	---				
Diâmetro do núcleo	40 mm / 75 mm (opcional)				
Enrolamento	externo ou interno				
Sensor de etiquetas	Transmissivo e reflexivo inferior				
<b>Fita de transferência</b>					
Lado da tinta	externo ou interno				
Diâmetro máx. dos rolos	Ø 80 mm				
Diâmetro do núcleo	25,4 mm / 1"				
Comprimento máx.	450 m				
Largura máx.	110 mm				
<b>Dimensões (mm)</b>					
largura x altura x profundidade	236 x 238 x 374				
Peso	11 kg				
<b>Sistema eletrônico</b>					
Processador	High Speed 32 Bit				
Memória de trabalho (RAM)	16 MB				
Entradas	Para cartão Compact Flash modelo I				
Bateria	Para relógio de tempo real (gravação de dados em caso de falha de energia)				
Sinal de aviso	Sinal sonoro em caso de avaria				
<b>Interfaces</b>					
Série	RS-232C (até 115200 Baud)				
Paralelo	SPP				
USB	2.0 High Speed Slave				
Ethernet	10/100 Base T, LPD, RawIP-Printing, DHCP, HTTP, FTP				
WLAN (opcional)	Módulo 802.11 b/g/n WEP, WPA, WPA-PSK, WPA2, WPA2-PSK, EAP				

1 = Térmica direta

2 = Transferência térmica



<b>Especificações</b>	<b>Vita II 103/8 T</b>	<b>Vita II 104/8</b>	<b>Vita II 106/12</b>	<b>Vita II 106/24</b>	<b>Vita II 108/12 T</b>
Tensão de alimentação	110 ... 230 V AC / 50-60 Hz				
Consumo de potência	275 VA				
Corrente	2,5 A				
Temperatura	5 ... 35 °C				
Humidade relativa	máx. 80 % (sem condensação)				
<b>Panel de comando</b>					
Teclas	Impressão de teste, menu, quantidade, cartão de memória, Feed, Enter, 4 x Cursor				
Visor LCD	Visor gráfico 132 x 64 pixéis				
<b>Definições</b>					
	Data, hora, intervalos 20 opções de língua (mais sob encomenda) Parâmetros de etiquetas e dos aparelhos, interfaces, proteção com palavra-chave				
<b>Verificações</b>					
Paragem da impressão em caso de	Fim da fita de transferência / fim das etiquetas / cabeça de impressão aberta				
Vista de estado	Vista das definições do aparelho, por ex. rendimento, parâmetros das células fotoelétricas, das interfaces e da rede Vista dos tipos de letra assim como de todos os códigos de barras suportados				
<b>Texto</b>					
Tipos de letra	6 Fontes Bitmap 8 Fontes vetoriais/TrueType 6 Fontes proporcionais Mais tipos de letra sob encomenda				
Conjunto de caracteres	Windows 1250 até 1257, DOS 437, 850, 852, 857, UTF-8 São suportados todos os caracteres da Europa ocidental e oriental, latinos, cirílicos, gregos e árabes (opcional). Mais conjuntos de caracteres sob encomenda				
Fontes bitmap	Tamanho em largura e altura 0,8 ... 5,6 Fator de ampliação 2 ... 9 Orientação 0°, 90°, 180°, 270°				
Fontes vetoriais/Fontes TrueType	Tamanho em largura e altura 1 ... 99 mm Fator de ampliação progressivo Orientação 0°, 90°, 180°, 270°				
Propriedades do texto	Dependendo do tipo de letra – negrito, itálico, invertido, vertical				
Espaçamento entre caracteres	Variável				
<b>Código de barras</b>					
Código de barras 1D	CODABAR, Code 128, Code 2/5 interleaved, Code 39, Code 39 extended, Code 93, EAN 13, EAN 8, EAN ADD ON, GS1-128, Identcode, ITF 14, Leitcode, Pharmacode, PZN 7 Code, PZN 8 Code, UPC-A, UPC-E				
Código de barras 2D	Aztec Code, CODABLOCK F, DataMatrix, GS1 DataMatrix, MAXICODE, PDF 417, QR Code				
Código de barras mistos	GS1 DataBar Expanded, GS1 DataBar Limited, GS1 DataBar Omnidirectional, GS1 DataBar Stacked, GS1 DataBar Stacked Omnidirectional, GS1 DataBar Truncated				
	Todos os códigos de barras são variáveis em altura, largura do módulo e proporção Orientação 0°, 90°, 180°, 270° Dígito de verificação e conversão de texto opcionais				
<b>Software</b>					
Configuração	ConfigTool				
Controlo do processo	NiceLabel				
Software das etiquetas	Labelstar Office Lite Labelstar Office				
Drivers Windows	Windows 7® - Windows 10® 32/64 Bit Windows Server 2008® (R2) - Windows Server 2019®				

Reserva-se o direito de alterações técnicas

## Limpeza



### PERIGO!

Perigo de vida por choque elétrico!

⇒ Antes de realizar todos os trabalhos de manutenção separar o sistema de impressão da rede elétrica e aguardar, por breves instantes, até que a fonte de alimentação se tenha descarregado.



### AVISO!

Recomenda-se o uso de dispositivos de proteção pessoais como óculos de proteção e luvas para a limpeza do aparelho.

Tarefa de manutenção	Frequência
Limpeza geral	Conforme necessário
Limpar o rolo de tração da fita de transferência.	Em cada substituição da película de transferência ou em caso de dano na imagem impressa.
Limpar o tambor de impressão.	Após cada mudança do rolo de etiquetas ou em caso de uma imagem de impressão deficiente ou problemas no transporte das etiquetas.
Limpar a cabeça de impressão.	<b>Impressão térmica direta:</b> Em cada substituição do rolo de etiquetas. <b>Impressão por transferência térmica:</b> Em cada substituição da película de transferência ou em caso de dano na imagem impressa.
Limpar a célula fotoelétrica das etiquetas.	Após cada mudança do rolo de etiquetas.



### AVISO!

Devem ser respeitadas as normas de manuseamento para utilização de Isopropanol (IPA). Em caso de contacto com a pele ou os olhos lavar bem sob água corrente. Em caso de irritações permanentes consultar o médico. Garantir uma boa ventilação.



### ATENÇÃO!

Perigo de incêndio devido a dissolventes inflamáveis para etiquetas!

⇒ Ao utilizar dissolventes para soltar etiquetas, a impressora de etiquetas deve ser limpa e livre de poeiras.

## Limpeza geral



### CUIDADO!

Agentes de limpeza agressivos danificam a impressora de etiquetas!

⇒ Não utilize agentes de limpeza abrasivos ou dissolventes para a limpeza das partes exteriores ou dos componentes.

⇒ Remova grãos de pó e pedaços de papel da zona de impressão com um pincel suave ou um aspirador.

⇒ Limpe as superfícies exteriores com um agente de limpeza tipo lava-tudo.

## Limpar o rolo de tração da fita de transferência

Sujidade no rolo de tração resulta numa má qualidade da impressão e também pode causar falhas no transporte do material.

- Abra a tampa da impressora.
- Remova as etiquetas e a fita de transferência da impressora de etiquetas.
- Remova o material depositado com o agente de limpeza do tambor e um pano suave.
- Se o tambor apresentar danos, substitua o tambor.

## Limpar o tambor de impressão

Sujidade no tambor de impressão resulta numa má qualidade da impressão e também pode causar falhas no transporte do material.



### CUIDADO!

Danos no cilindro de impressão!

⇒ Não utilizar objetos com arestas afiadas, pontiagudos ou duros para a limpeza do cilindro de impressão.

- Gire o manípulo ao contrário do sentido dos ponteiros do relógio para destravar a cabeça de impressão.
- Remova as etiquetas e a fita de transferência da impressora de etiquetas.
- Remova o material depositado com o agente de limpeza do tambor e um pano suave.
- Se o tambor apresentar danos, substitua o tambor.

## Limpar a cabeça de impressão

A impressão deposita sujidade na cabeça de impressão, por exemplo através das partículas de tinta da fita de transferência. Por isso é indicado e necessário limpar a cabeça de impressão em determinados intervalos de tempo, dependendo das horas de funcionamento e das condições ambientais, tais como poeiras etc.



### CUIDADO!

Danos na cabeça de impressão!

⇒ Não utilizar objetos com arestas afiadas, pontiagudos ou duros para a limpeza da cabeça de impressão.

⇒ Não toque na camada de proteção de vidro da cabeça de impressão.

- Gire o manípulo ao contrário do sentido dos ponteiros do relógio para destravar a cabeça de impressão.
- Remova as etiquetas e a fita de transferência da impressora de etiquetas.
- Limpe a superfície da cabeça de impressão com um cotonete embebido em álcool puro.
- Deixe a cabeça de impressão secar durante 2 a 3 minutos antes de colocar a impressora de etiquetas em funcionamento.

## Limpar a célula fotoelétrica de etiquetas



### CUIDADO!

Perigo de danificar a célula fotoelétrica!

⇒ Não utilize objetos afiados ou duros ou agentes dissolventes para a limpeza da célula fotoelétrica.

A célula fotoelétrica pode ficar suja com o pó do papel. Isto pode comprometer a deteção das etiquetas.

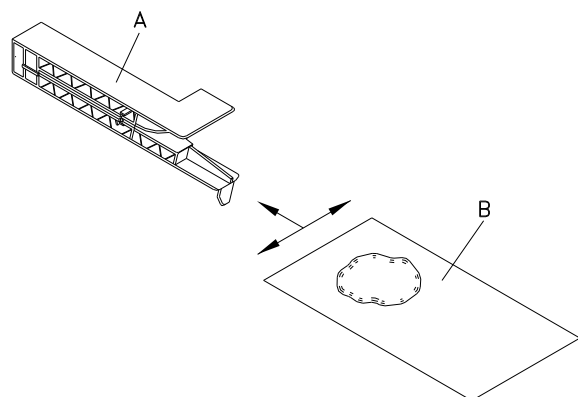

- Gire o manípulo ao contrário do sentido dos ponteiros do relógio para destravar a cabeça de impressão.
- Remova as etiquetas e a fita de transferência da impressora de etiquetas.
- Sopre a célula fotoelétrica (A) com um spray de gás comprimido. Observar as indicações constantes na lata.
- A célula fotoelétrica das etiquetas (A) pode ser limpa adicionalmente com um cartão de limpeza (B) o qual é humidificado anteriormente com álcool puro. O cartão de limpeza deve ser movido para a frente e para trás (veja a figura).
- Insira outra vez as etiquetas e a fita de transferência.



Kısa kullanım kılavuzu ve ürün  
güvenliğiyle ilgili uyarılar

Türkçe

copyright by Carl Valentin GmbH

Teslimat, görünüm, kapasite, ölçüler ve ağırlık ile ilgili veriler, baskı anındaki mevcut bilgilerimize uygundur. Değişiklik hakkı saklıdır.

Çeviri dahil, tüm hakları saklıdır.

Eserin, hiçbir bölümü, hiçbir şekilde (basım, fotokopi veya başka bir yöntemle) Carl Valentin GmbH şirketinin yazılı izni olmadan yeniden üretilemez veya elektronik sistemler yardımıyla işlenemez, çoğaltılamaz veya dağıtılamaz.

Cihazlar sürekli geliştirildiğinden doküman ve cihaz arasında farklılıklar olabilir.

Güncel baskı için [www.carl-valentin.de](http://www.carl-valentin.de) adresine bakınız.

#### **Ticari marka**

Belirtilen tüm markalar veya ticari markalar, ilgili sahiplerine ait tescilli markalar veya tescilli ticari markalar olup ayrıca işaretlenmiş olmayabilir. İşaretlemenin olmamasından, tescilli bir markanın veya tescilli bir ticari markanın söz konusu olmadığı sonucuna varılamaz.

Carl Valentin etiket yazıcıları aşağıdaki güvenlik yönergelerine uygunluk göstermektedir:

**CE** Alçak Voltaj Yönergesi (2014/35/EU)

Yönergesi Elektromanyetik Kirlilik (2014/30/EU)



#### **Carl Valentin GmbH**

Postfach 3744  
78026 Villingen-Schwenningen  
Neckarstraße 78 – 86 u. 94  
78056 Villingen-Schwenningen

Phone +49 7720 9712-0  
Fax +49 7720 9712-9901

E-Mail [info@carl-valentin.de](mailto:info@carl-valentin.de)  
Internet [www.carl-valentin.de](http://www.carl-valentin.de)

**İçindekiler**

Tekniğine uygun kullanım	176
Güvenlik uyarıları	176
Çevre dostu tasfiye	176
İşletim koşulları	177
Etiket yazıcısının ambalajından çıkarılması	180
Teslimat kapsamı	180
Etiket yazıcısının kurulumu	180
Etiket yazıcısının bağlantısının yapılması	180
Etiket yazıcısının devreye alma	180
Yırtma modunda bir etiket rulosunu yerleştirme	181
Transfer folyosunun takılması	182
Print Settings (Yazdırmayı başlatma)	183
Label Layout (Etiketlerin düzeni)	183
Device Settings (Cihaz parametreleri)	184
Network (Ağ)	186
Password (Şifre)	186
Interface (Arabirimler)	187
Emulation (Emülasyon)	187
Date & Time (Tarih ve saat)	188
Service Functions (Servis işlevleri)	189
Main Menu (Ana menü)	191
Compact Flash kartı	192
Teknik veriler	196
Aktarma şeridi-çekme merdanesini temizleyin	198
Baskı merdanesinin temizlenmesi	199
Yazdırma kafasının temizlenmesi	199
Etiket ışık bariyerinin temizlenmesi	199

## Tekniğine uygun kullanım

- Etiket yazıcısı en ileri teknoloji ve onaylanan güvenlik tekniği prensiplerine göre üretilmiştir. Buna rağmen kullanım sırasında kullanıcıya veya üçüncü kişilere yönelik bedensel ve hayati tehlikeler ya da etiket yazıcısı veya başka maddi değerler üzerinde olumsuz etkiler meydana gelebilir.
- Etiket yazıcısı yalnızca teknik yönden sorunsuz bir durumda olduğu takdirde, ayrıca usulüne göre, güvenlik ve tehlike bilinciyle bu kullanım kılavuzunun dikkate alınması koşuluyla kullanılabilir! Özellikle güvenliği olumsuz yönde etkileyen arızalar derhal giderilmelidir.
- Etiket yazıcısı yalnızca uygun ve üretici tarafından izin verilen malzemelerin yazdırılması için tasarlanmıştır. Başka ya da bunun dışındaki kullanımlar usulüne uygun değildir. Amaç dışı kullanımdan kaynaklanabilecek hasarlardan üretici/teslimatçı sorumlu değildir; bu riski tek başına kullanıcı taşır.
- Usulüne uygun kullanım kapsamına ayrıca kullanım kılavuzunun dikkate alınması ve üretici tarafından verilen bakım tavsiyeleri/talimatları da dahildir.

## Güvenlik uyarıları

- Etiket yazıcısı 110 ... 230 V AC gerilimli akım şebekeleri için tasarlanmıştır. Etiket yazıcısını yalnızca topraklı prizlere bağlayın.
- Etiket yazıcısını yalnızca topraklı alçak gerilim ileten cihazlara bağlayın.
- Bağlantıları oluşturmadan veya çıkarmadan tüm bağlı cihazları (bilgisayar, yazıcı, aksesuar) kapatın.
- Etiket yazıcısını yalnızca kuru bir ortamda çalıştırın ve ıslaklığa (püskürtme suyu, sis, vs.) maruz bırakmayın.
- Bakım ve koruyucu bakım çalışmaları sadece eğitimli uzman personel tarafından yapılabilir.
- Kumanda personeli, işletmeci tarafından kullanım kılavuzu ile bilgilendirilmelidir.
- Etiket yazıcısı kapağı açık olarak çalıştırılacaksa, elbise, saç, takı veya kişilerin üzerinde taşıdıkları benzeri eşyaların açıkta duran, döner parçalarla temas etmemesine dikkat edin.
- Cihaz ve parçalar (örn. baskı kafası), baskı sırasında ısınabilir. Çalışma sırasında dokunmayın ve malzeme değişikliğinden, sökmeyen veya ayarlamadan önce soğumasını bekleyin.
- Kesinlikle hafif yanıcı materyal kullanmayın.
- Yırtma kenarından dolayı yaralanma riski vardır. Yırtma kenarı kullanılmadığında kenar koruma profilini takın.
- Yalnızca bu kullanım kılavuzunda belirtilen işlemleri uygulayın. Bunun ötesindeki çalışmalar sadece üretici tarafından ya da üretici ile koordineli olarak yapılabilir.
- Elektronik yapı gruplarındaki ve bunların yazılımlarındaki amacına uygun olmayan müdahaleler, arızalara neden olabilir.
- Cihaz üzerindeki amacına uygun olmayan işlemler veya değişiklikler, çalışma güvenliğini tehlikeye sokabilir.
- Servis çalışmalarının her zaman gerekli çalışmayı gerçekleştirmek için gerekli uzman bilgisine ve takımlarına sahip olan yetkili bir atölyede yapılmasını sağlayın.
- Cihazlarda tehlikelere dikkat çeken çeşitli ikaz uyarıları takılmıştır. Bu yapıştırmaları sökmeyin, aksi takdirde tehlikeler algılanmaz.



### TEHLİKE!

Şebeke gerilimi nedeniyle ölüm tehlikesi!

⇒ Cihazın mahfazasını açmayın.

## Çevre dostu tasfiye

B2B cihazlarının üreticilerinin 23.03.2006 tarihinden itibaren, 13.08.2005 tarihinden sonra üretilen cihazları geri alması ve imha etmesi gerekir. Bu eski cihazların halka açık toplama yerlerine verilmesi prensip olarak yasaktır. Bunlar sadece üretici tarafından organize edilmiş olarak yeniden değerlendirilebilir ve imha edilebilir. Bu nedenle uygun işaretlere sahip olan Valentin ürünleri bundan sonra Carl Valentin GmbH şirketine geri verilebilir.

Buna göre eski cihazlar, gerektiği gibi imha edilecektir.

Carl Valentin GmbH şirketi bu sayede eski cihazların imhası çerçevesinde her türlü sorumluluğu gerektiği şekilde gerçekleştirir ve bu sayede ürünlerin sorunsuz bir şekilde dağıtımını sağlamaya da devam eder. Sadece gönderi ücreti karşılanmış olan cihazların iadesini kabul edebiliriz.

Baskı mekanizmasının elektronik platin bir lityum iyon pil ile donatılmıştır. Bu pil, mağazanın atık pil toplama haznelerinde veya halka açık yasal tasfiyeciler üzerinden tasfiye edilmelidir.

Ayrıntılı bilgileri WEEE yönetmeliğinden veya [www.carl-valentin.de](http://www.carl-valentin.de) adresindeki internet sayfamızdan edinebilirsiniz.



## İşletim koşulları

İşletme koşulları, güvenli ve arızasız bir çalışma sağlamak için cihazlarımızı devreye sokmadan önce ve işletme sırasında gerçekleştirilmiş olması gereken koşullardır.

Lütfen işletme koşullarını dikkatli bir biçimde okuyun.

İşletme koşullarının pratik olarak uygulanmasıyla ilgili olarak sorularınız olduğu takdirde, bizimle veya sizin için yetkili müşteri hizmetleriyle irtibata geçin.

## Genel bilgiler

Cihazlar, kurulumu kadar sadece orijinal ambalajlarında taşınmalı ve saklanmalıdır.

Cihazlar, işletme koşulları yerine getirilmeden önce kurulmamalı ve devreye sokulmamalıdır.

Cihazlarımızı devreye sokma, programlama, kullanma, temizleme ve bakımdan geçirme sadece talimatlarımızı iyice okunduktan sonra gerçekleştirilmelidir.

Cihazlar sadece gerekli eğitimleri almış personel tarafından kullanılmalıdır.



### DUYURU!

Eğitimlerin tekrarlanması tavsiye ederiz.

Eğitim içeriklerinin konu başlıkları 'İşletme koşulları', 'Aktarma bandını takma' ve 'Temizlik ve bakım'.

Uyarılar, bizim sağladığımız yabancı cihazlar için de geçerlidir.

Sadece orijinal yedek parçalar ve değiştirme parçaları kullanılmalıdır.

Yedek ve yıpranan parçalar için lütfen üreticisine başvurun.

## Kurulum yeri için geçerli koşullar

Kurulum alanının düz, sarsıntısız, salınım ve hava akımı olmayan bir yer olması gerekir.

Cihazlar, ideal bir kullanımı ve bakım için kolay bir erişimi garanti edecek şekilde yerleştirilmelidir.

## Standart adaptörü takma

Cihazlarımızı bağlamak için adaptörün, uluslararası yönetmeliklere ve bunlara dayanan kurallara göre takılması gerekir. Bunların arasında özellikle aşağıdaki üç komisyonun tavsiyeleri de vardır:

- Uluslararası Elektronik Komisyon (IEC)
- Avrupa Elektronik Standartları Komitesi (CENELEC)
- Alman Elektrik Teknisyenleri Birliği (VDE)

Cihazlarımız VDE güvenlik sınıfı I'e göre yapılmıştır ve bir koruyucu iletken bağlantısına bağlanmaları gerekir. Standart adaptörün, cihazın içindeki arızalı akımları gidermek için bir koruyucu iletken bağlantısının bulunması gerekir.

## Adaptörle ilgili teknik veriler

Şebeke voltajı ve şebeke frekansı:	Model plakasına bakın
Şebeke voltajı için izin verilen tolerans:	Nominal değer +% 6 ... -% 10
Şebeke frekansı için izin verilen tolerans:	Nominal değer +% 2 ... -% 2
Şebeke voltajı için izin verilen distorsiyon faktörü:	≤ 5 %

### Arıza giderme yöntemleri:

Çok aşırı kirli şebekelerde (örneğin tristör kumandalı tesisler kullanıldığında) fabrikada arıza giderme önlemlerinin alınması gerekir. Örneğin aşağıdaki seçenekleriniz bulunur:

- Cihazlarımıza gelen ayrı şebeke hatları döşeyin.
- Sorun oluştuğunda kapasite olarak ayrılan ayırma trafosunu veya diğer arıza giderme cihazlarını cihazlarımızın önündeki şebeke hattına takın.

## Parazit ışınları ve parazitlere karşı dayanıklılık

Endüstri bölgesi - EN 61000-6-3: 2007 uyarınca parazit yayını/emisyon

- EN 55022: 09-2003 uyarınca hatlardaki arızalı gerilim
- EN 55022 uyarınca parazit alanı gücü 09-2003
- EN 61000-3-2 uyarınca üst titreşim akımları (şebeke tepkisi): 09-2006
- EN 61000-3-3 uyarınca titreşim: 1955 + A1:2001 + A2:2005

Endüstri bölgesi - EN 61000-6-2: 2005 uyarınca parazite karşı dayanıklılık

- EN 61000-4-2: 12-2001 uyarınca statik elektrik boşalmasına karşı parazitlere karşı dayanıklılık
- EN 61000-4-3: 11-2003, ENV 50204: 03-1995 uyarınca elektromanyetik alanlar
- EN 61000-4-4: 07-2005 uyarınca hızlı geçici parazitlere (patlama) karşı dayanıklılık
- EN 61000-4-5: 12-2001 uyarınca yüksek frekanslı alanlardan kaynaklanan, iletken hatlardaki parazitlere karşı dayanıklılık
- EN 61000-4-6: 12-2001 uyarınca HF voltajı
- EN 61000-4-11: 02-2005 uyarınca voltaj kesintileri ve voltaj düşüşleri



### DUYURU!

Bu, A sınıfı bir tertibattır. Bu tertibat, ikamet alanında telsiz arızalarına neden olabilir; bu durumda işletenden uygun önlemleri alması ve bunları karşılaması istenebilir.

## Harici cihazlarla bağlantı hatları

Tüm bağlantı hatlarının yalıtılmış hatlardan geçirilmesi gerekir. Yalıtım örgüsünün her iki tarafta da fiş mahfazasının alanına bağlanması gerekir.

Akım hatlarıyla paralel hat döşemesi bulunmamalıdır. Kaçınılmaz paralel döşeme durumlarında en az 0,5 m'lik bir asgari mesafeye uyulması gerekir.

Bağlantıların sıcaklık aralığı: -15 ... +80 °C.

Sadece 'Safety Extra Low Voltage' (SELV – Güvenlik Ek Düşük Voltajı) şartını sağlayan elektrik devrelerine sahip olan cihazlar bağlanmalıdır. Bunlar genellikle EN 60950/EN 62368-1 standardına göre kontrol edilmiş olan cihazlardır.

## Veri hatlarının kurulumu

Veri kablolarının tam yalıtılmış ve metal ya da metali takma bağlantısı mahfazalarıyla donatılmış olması gerekir. Yalıtılmış kablo ve takma bağlantıları, elektrikli arızaların yayılmasını ve alınmasını önlemek için gerekir.

İzin verilen hatlar

Yalıtımlı hat: 4 x 2 x 0,14 mm<sup>2</sup> ( 4 x 2 x AWG 26)  
6 x 2 x 0,14 mm<sup>2</sup> ( 6 x 2 x AWG 26)  
12 x 2 x 0,14 mm<sup>2</sup> (12 x 2 x AWG 26)

Gönderme ve alma hatlarının çift olarak döşenmesi gerekir.

Maksimum hat uzunlukları: V 24 (RS232C) arabiriminde - 3 m (yalıtım dahil)  
Paralel port - 3 m (yalıtım dahil)  
USB - 3 m  
Ethernet - 5 m

## Hava dolaşımı

İzin verilmeden bir ısınmayı önlemek için, cihazın çevresinde serbest bir hava dolaşımının oluşabilmesi gerekir.

## Sınır deęerleri

IP'ye gre koruma tr:	20
Ortam sıcaklıęı °C (iřletme):	min. +5 maks. +35
Ortam sıcaklıęı °C (depolama):	min. -20 maks. +60
Nispi nem oranı % (iřletme):	maks. 80
Nispi nem oranı % (depolama):	maks. 80 (cihazların buęulanmasına izin verilmez)

## Garanti

Ařaęıdakilerden kaynaklanabilecek hasarlardan dolayı hibir sorumluluk kabul etmeyiz:

- İřletme kořullarımıza ve kullanım kılavuzuna uyulmaması.
- evrenin hatalı elektrik tesisatı.
- Cihazlarımız zerinde yapılan yapısal deęiřiklikler.
- Hatalı programlama ve kullanım.
- Yapılmayan veri yedeklemesi.
- Orijinal olmayan yedek paraların ve aksesuarların kullanılması.
- Doęal ařınma ve yıpranma.

Cihazları yeni ayarladıęınızda veya programladıęınızda, yeni ayarı bir deneme alıřtırması ve deneme yazdırması yardımıyla kontrol edin. Bu sayede hatalı sonuları, izimleri ve deęerlendirmeleri nlersiniz.

Cihazlar sadece gerekli eęitimleri almıř alıřanlar tarafından kullanılmalıdır.

rnlerimizin dzgn kullanılıp kullanılmadıęını kontrol edin ve eęitimleri tekrarlayın.

Bu kullanım kılavuzunda aıklanan zelliklerin tm modellerde bulunduęunu garanti etmiyoruz. Srekli geliřtirme ve iyileřtirme gayretimizden dolayı, haber verilmeksizin teknik verilerde deęiřiklikler olabilir.

Srekli geliřtirme veya lkeye zel kurallardan dolayı kullanım kılavuzundaki resim ve rnekler, teslim edilen modelden farklı olabilir.

Hasarların nne gemek veya cihazın vaktinden nce ařınmasını nlemek iin ltfen izin verilen yazıcı ortamları hakkındaki bilgilere ve cihazın bakımıyla ilgili uyarılara dikkat edin.

Bu elkitabını anlařılır bir biimde hazırlamaya ve size olabildięince ok bilgi saęlamaya alıřtık. Elkitaplarımızı iyileřtirebilmemiz iin, herhangi bir sorunuz varsa veya herhangi bir hata bulduęunuzda ltfen bunları bize bildirin.

### Etiket yazıcısının ambalajından çıkarılması

- ⇒ Etiket yazıcıyı, cihazın altından kaldırıp kartondan çıkarın.
- ⇒ Etiket yazıcısını nakliye hasarlarına karşı kontrol edin.
- ⇒ Teslimatın eksiksiz olduğunu kontrol edin.

### Teslimat kapsamı

- Etiket yazıcısı.
- Boş folyo göbeği, transfer folyosu toplayıcısına takılı.
- Yırtma kenarı (yalnızca temel cihazlarda).
- Besleme kenarı (yalnızca besleme cihazlarında).
- Şebeke kablosu.
- Dokümantasyon.
- Yazıcı sürücüsü CD'si.
- Labelstar Office LITE.



#### DUYURU!

Orijinal ambalajı ileriki taşıma işleri için muhafaza edin.

### Etiket yazıcısının kurulumu



#### DİKKAT!

Nem ve ıslaklık nedeniyle cihaz ve yazdırma malzemeleri hasar görebilir.

- ⇒ Etiket yazıcısını yalnızca kuru ve püskürtme suyuna karşı korumalı yerlere kurun.
- ⇒ Yazıcıyı düz bir zemin üzerine kurun.
- ⇒ Etiket yazıcısının kapağını açın.
- ⇒ Köpük malzemeli koruyucu nakliye malzemelerini yazdırma kafası bölgesinden uzaklaştırın.

### Etiket yazıcısının bağlantısının yapılması

Yazıcı geniş aralıklı bir şebeke adaptörüyle donatılmıştır. Cihaza müdahale etmeksizin, 110 ... 230 V AC / 50-60 Hz değerindeki bir şebeke gerilimiyle işletilmesi mümkündür.



#### DİKKAT!

Cihaz, tanımlanamayan çalıştırma akımlarından dolayı hasar görmüş.

- ⇒ Şebeke bağlantısından önce şebeke şalterini "0" konumuna getirin.
- ⇒ Şebeke kablosunu şebeke bağlantı yuvasına takın.
- ⇒ Şebeke kablosunun fişini topraklı prize takın.



#### DUYURU!

Topraklamanın yetersiz olması veya hiç olmaması durumunda, çalıştırılırken arızalar meydana gelebilir. Etiket yazıcısına bağlı olan tüm bilgisayarların ve bağlantı kablolarının topraklı olduğuna dikkat edin.

- ⇒ Etiket yazıcısını bilgisayara veya ağ sistemine uygun bir kablo ile bağlayın.

### Etiket yazıcısının devreye alma

Tüm bağlantılar kurulduktan sonra:

- ⇒ Tüm bağlantılar oluşturulduktan sonra:  
Yazıcı çalıştırıldıktan sonra, yazıcı tipinin ve geçerli tarih ve saatin görülebildiği ana menü belirir.
- ⇒ Etiket malzemesini ve aktarma şeridini yerleştirin.
- ⇒ *Etiketlerin düzeni/Etiki ölçün* (Label layout/Measure label) menüsünden ölçü işlemini başlatın.
- ⇒ Folyo klavyesindeki  tuşuna basarak ölçme işlemini sona erdirebilirsiniz.



#### DUYURU!

Doğru bir ölçümün yapılabilmesi için, en az iki tam etiketin ileri itilmesi gerekir (yazıcı etiketlerinde bu gerekmez).

Etiket ve aralık uzunlukları yazıcıyla ölçüldüğünde küçük farklılıklar oluşabilir. Bu nedenle değerler, *Etiketlerin düzeni/Etiket ve Aralık* (Label layout/Label and Gap) menüsünde manüel olarak ayarlanabilir.

## Yırtma modunda bir etiket rulosunu yerleştirme

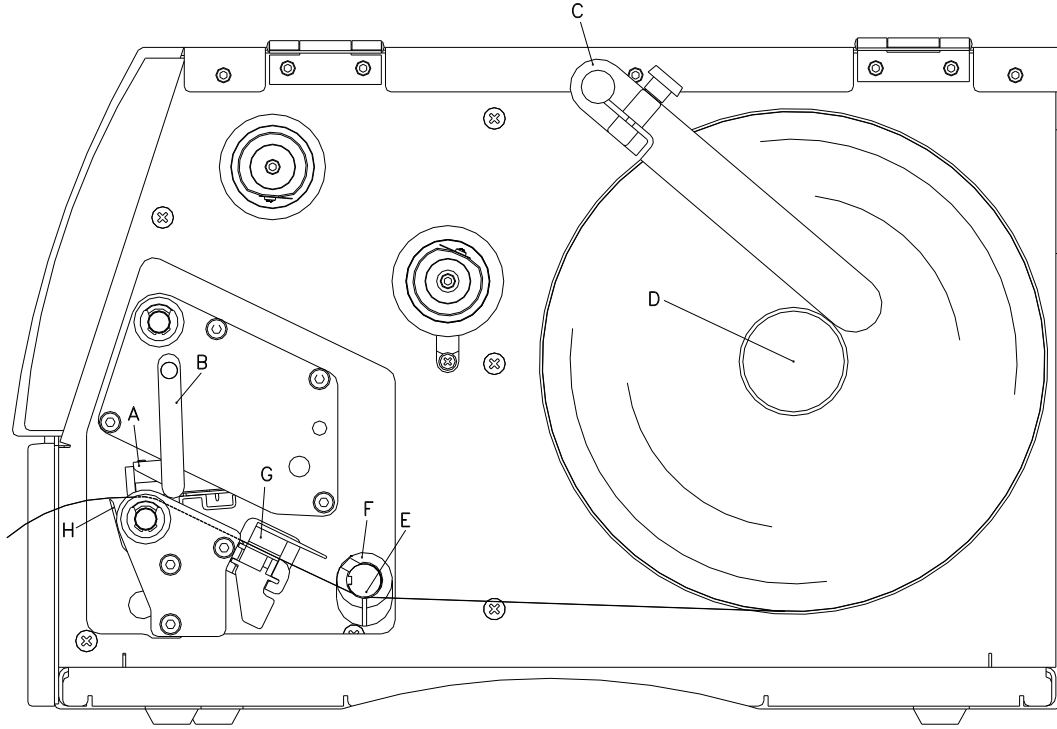

- Yazıcının kapağını açın.
- Baskı başını (G) açmak için kırmızı baskı kolunu (F) saat istikametinin tersine çevirin.
- Harici etiket yuvasını (A) sökün.
- Etiket rulosunu içeriden sararak çözme tertibatına (B) geçirin ve etiket yuvasını (A) tekrar takın.
- Etiket malzemesini saptırma milinin (C) ve baskı başının (G) altından geçirin ve malzemenin fotoselin (E) içinden geçmesine dikkat edin.
- Baskı başını (G) çevirmek için, kırmızı baskı kolunu (F) yerine oturana kadar saat istikametinin tersine doğru çevirin.
- Baskı başının önünde, yırtma kenarını (H) görebilirsiniz.
- *Basıncı başlatma/yırtma kenarı* (Print settings/Tear-off' menü seçeneğinde sapma değerini girin.
- Saptırma milindeki (C) ayar halkalarını (D) malzeme genişliğine göre ayarlayın.
- Yazıcının kapağını tekrar kapatın.

## Transfer folyosunun takılması



### DUYURU!

Isı aktarma baskı yöntemi için renkli bir şeridin yerleştirilmesi gerekir. Yazıcı doğrudan ısı baskısı için kullanıldığında renkli şerit yerleştirilmez. Yazıcıda kullanılan renkli şeritlerin en az baskı ortamı genişliğinde olması gerekir. Renkli şeridin baskı ortamından daha dar olması durumunda baskı başı kısmen korumasız kalır ve vaktinden önce aşınır.

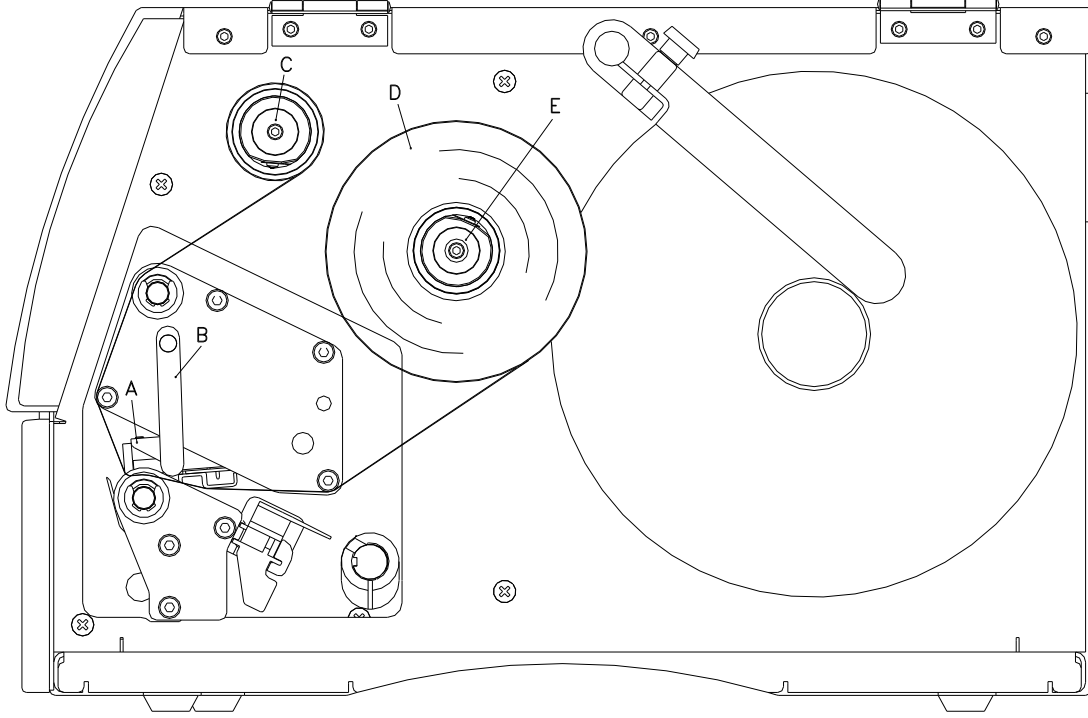

### DUYURU!

Yeni bir aktarma şeridi rulosunu yerleştirmeden önce, baskı başı baskı başı ve merdane temizleyicisi (97.20.002) ile temizlenmelidir. Isopropanol (IPA)'nın kullanılmasına ilişkin işleme talimatlarına uyulmalıdır. Deri veya gözlerinize ile temas olursa, bol su ile iyice yıkayın. Eğer tahriş hissi devam ederse doktora başvurun. İyi havalandırma olmasını sağlayın.

- Transfer folyosunu takmadan önce yazdırma kafasını temizleyin.
- Yazıcının kapağını açın.
- Baskı başını (E) açmak için kırmızı baskı kolunu (D) saat istikametinin tersine çevirin.



### DİKKAT!

Transfer bandını yerleştirirken veya kullanılmış transfer bandını çıkarırken sürtünme tehlikesi!  
⇒ Yayı plakanın kenarlarına dikkat edin!

- Aktarma şeridi rulosunu (B) dışarıdan sararak çözme rulosuna (C) takın.
- Renkli şeridin boş bir çekirdeğini sarma rulosunun (A) üzerine geçirin ve aktarma şeridini basınç başının altından geçirin.
- Aktarma şeridi başlangıcını bir yapışkanla sarma rulosunun (A) boş çekirdeğine sabitleyin. Burada aktarma şeridi çözmesinin dönme yönünün saat istikametinin tersine döndüğünü unutmayın.
- Baskı başını (E) çevirmek için, kırmızı baskı kolunu (D) yerine oturana kadar saat istikametinin tersine doğru çevirin.
- Yazıcının kapağını tekrar kapatın.



### DUYURU!

Elektrostatik deşarj sonucu ısı baskı başının ince kaplaması ya da diğer elektronik parçalar zarar görebileceğinden, aktarma şeridinin antistatik olması gerekir. Yanlış malzemelerin kullanılması, yazıcının hatalı çalışmasına ve garanti hakkının kaybolmasına neden olabilir.



### DİKKAT!

Statik materyal, insana etki edebilir.

⇒ Bandı çıkarırken, statik boşalma meydana gelebileceğinden, antistatik transfer bandı kullanın.

## Print Settings (Yazdırmayı başlatma)

Tuş sırası:  F,

### Speed (Hız)

Baskı hızı (mm/sn).  
50 mm/sn ... 200 mm/sn arasındaki değer alanı (bakın "Teknik veriler").

### Contrast (Yakma gücü)

Çeşitli malzeme, baskı hızı veya baskı içerikleri kullanıldığında baskı yoğunluğunu ayarlama değeri bilgisi.  
% 10 ... % 200 arasındaki değer alanı.

Tuş:

### Ribbon control (TR bandının kontrolü)

Aktarma şeridi rulusunun bitip bitmediğinin veya çözme makarasındaki aktarma şeridinin yırtılıp yırtılmadığının kontrolü.

**Off (Kapalı):** Aktarma şeridi kontrolü devre dışı.

**On, weak sensibility (Açık, zayıf hassasiyet):** Aktarma şeridi kontrolü etkin. Modül, aktarma şeridi sonuna yaklaşık 1/3 oranında daha yavaş tepki gösterir (default).

**On, strong sensibility (Açık, güçlü hassasiyet):** Aktarma şeridi kontrolü etkin. Modül, aktarma şeridi sonuna hemen tepki gösterir.

Tuş:

### Y Offset (Y kaydırması)

Sıfır noktası kaydırmasının mm cinsinden değeri.  
Değerler alanı: -30,0 ... +90,0 arası

Tuş:

### X Offset (X kaydırması)

Bütün baskı ekranının kağıdın gidiş yönünün çaprazlamasına kaydırılması.  
Değerler alanı: -90,0 ... +90,0 arası

Tuş:

### Tear-off Offset (Yırtılma kenarı)

Bir baskı işinin son etiketinin öne doğru kaydırıldığı ve yeniden baskı başladığında tekrar arkaya doğru etiket başlangıcına çekildiği değer bilgisi.  
Değerler alanı: 0 ... 50,0 mm arası  
Standart: 12 mm.

## Label Layout (Etiketlerin düzeni)

Tuş sırası:  F, ,

### Label length (Etiket uzunluğu)

Etiket uzunluğu (mm).  
Tavsiye edilen asgari yükseklik: 5 mm (verici 25 mm)

### Gap length (Aralık uzunluğu)

İki etiket arasındaki mesafe (mm).  
Tavsiye edilen asgari değer: 1 mm

Tuş:

### Column printing (Çok şeritli baskı)

Bir etiketin genişliğiyle ilgili bilgiler ve taşıyıcı malzemenin üzerinde yan yana kaç etiket olduğuna dair bilgiler.

Tuş:

### Measure label (Etiketi ölçün)

Ölçme işlemini  tuşuyla başlatın.

Tuş:

### Label type (Etiket tipi)

Standart olarak yapışkanlık etiketler ayarlanmıştır. Yazıcı etiketlerini seçmek için  düğmesine basın.

Tuş:

### Material selection (Materyali seçimi)

Kullanılan baskı ortamını seçme.

Tuş:

### Photocell (Işık eşiği)

Kullanılan fotoseli seçme.  
Aşağıdaki seçenekler kullanılabilir: Normal ve ters aydınlatma fotoseli, normal ve ters yansıtma fotoseli, ultrason fotoseli (seçenek).

### SP - Scan position (Dokunma konumu - SP)

Bu işlev yardımıyla, etiket sonunun arandığı etiketin uzunluğunu yüzde olarak girebilirsiniz.

Tuş: **Label error length  
(Etiketin hata uzunluğu)**

Bir hata durumunda bir mesajın ekranda kaç mm sonra görünmesini istediğinizin bilgisi. 1 ile 999 mm arasındaki değer alanı

**Synchronization  
(Senkronizasyon)**

**On (Açık):** Taşıyıcı bantta etiket eksik, bir hata mesajı gösterilir.  
**Off (Kapalı):** Eksik etiketler göz ardı edilir, yani aralığın içine yazdırılır.

Tuş: **Flip label  
(Etiketi yansıtın)**

Yansıtma eksenini, etiketin ortasında bulunur. Etiket genişliği yazıcıya aktarılmadığında, varsayılan etiket genişliği, yani baskı başının genişliği kullanılır. Bu nedenle etiketin baskı başıyla aynı genişlikte olmasına dikkat etmeniz gerekir. Aksi takdirde yerleştirmede sorun çıkmasına neden olabilir.

Tuş: **Rotate label  
(Etiketi çevirin)**

Standart olarak etiket, başı önde olarak 0° çevirmeye yazdırılır. Bu işlev devreye sokulduğunda etiket 180° çevrilir ve okuma yönünde yazdırılır.

Tuş: **Rotate label in degrees  
(Etiketi derece olarak döndürme)**

*Etiketi döndür* parametresine uygun olarak Etiket 90°C lik adımlarla döndürülebilir.

**DUYURU!**

Sadece yazıcı dahilindeki Objeler (Metin, Çizgi ve Barkodlar) döndürülebilir. Grafiklerin döndürülmesi mümkün değildir.

Tuş: **Alignment  
(Hizalama)**

Etiketin yönlendirilmesi ancak çevirmeden/yansıtmadan sonra gerçekleştirilir, yani yönlendirme, çevirmeden ve yansıtmadan bağımsızdır.

**Left (Bağlantılar):** Etiket, baskı başının sol kenarında hizalanır.  
**Centre (Orta):** Etiket, baskı başının orta noktasında hizalanır (ortalanan).  
**Right (Sağ):** Etiket, baskı başının sağ kenarında hizalanır.

**Device Settings (Cihaz parametreleri)**Tuş sırası: **F**, , , **Field handling  
(Alan yönetimi)**

**Off (Kapalı):** Tüm yazıcı belleği silinir.  
**Keep graphic (Grafığı alın):** Bir grafik veya bir TrueType yazı tipi bir kez yazıcıya aktarılır ve yazıcının dahili belleğine kaydedilir. Aşağıdaki yazdırma işi için artık sadece değiştirilen veriler, yazıcıya aktarılır. Bunun avantajı, grafik verilerinin aktarma süresinin tasarruf edilmesidir.  
**Delete graphic (Grafığı silin):** Yazıcının dahili belleğine kaydedilen grafikler veya TrueType yazı tipleri silinir, diğer alanlar ise saklı kalır.  
**Restore graphic (Grafığı yeniden yükle):** Bir yazdırma görevinden sonra, yazdırılan görev yazıcıda yeniden başlatılabilir. Tüm grafikler ve TrueType yazı tipleri yeniden yazdırılır.

**DUYURU!**

**İstisna:** Çok şeritli yazdırma işleminde daima dolu şeritler yazdırılmalıdır (adet sayısı daima şeridin çok katı olmalı). Silinen şeritler yeniden yüklenmez.

Tuş: **Codepage  
(Kod sayfası)**

Kullanılan karakter setini seçme. Aşağıdaki seçenekler kullanılabilir:  
kod sayfası 437, kod sayfası 850, kod sayfası 852, kod sayfası 857, kod sayfası 1250, kod sayfası 1251, kod sayfası 1252, kod sayfası 1253, kod sayfası 1254, kod sayfası 1257, WGL4.  
Adı geçen karakter setlerinin çizelgesini web sayfamızda bulabilirsiniz.

Tuş: **External parameters  
(Harici Parametre)**

**Label dimension only (Sadece etiket ölçüleri):** Etiket uzunluğu, yarı uzunluğu ve etiket genişliği gibi parametreler aktarılabilir. Tüm diğer parametre ayarları direkt olarak yazıcı üzerinde yapılacaktır.  
**On (Açık):** Parametreler, etiket tasarlama yazılımımız üzerinden yazıcıya aktarılabilir. Daha önce doğrudan yazıcıda ayarlanmış olan parametreler artık dikkate alınmaz.  
**Off (Kapalı):** Sadece doğrudan yazıcı üzerinde yapılan ayarlar dikkate alınır.



Tuş: **Buzzer  
(Sesli uyarıcı)**

**On (Açık):** Her tuşa basıldığında sesli bir sinyal duyulur.  
Değerler alanı: 1 ... 7 arası  
**Off (Kapalı):** Hiçbir sinyal duyulmaz.

**Display  
(Ekran)**

Ekrandaki karşıtlığı ayarlama.  
Değerler alanı: 45 ... 75 arası

Tuş: **Printer language  
(Yazıcının dili)**

Metinlerin yazıcının göstergesinde gösterilmesini istediğiniz dili seçin.  
Aşağıdaki seçenekler kullanılabilir: Almanca, İngilizce, Fransızca, İspanyolca, Fince, Çek, Portekizce, Hollandaca, İtalyanca, Danca, Polonya, Yunan, Macar, Rusça, Çince (opsiyon), Ukraynaca, Türk, İsveç, Norveçli, Estonca.

Tuş: **Keyboard layout  
(Klavye yerleşimi)**

İsteddiğiniz klavye yerleşiminin alan şemasının seçilmesi.  
Aşağıdaki seçenekler kullanılabilir: Almanya, İngiltere, Fransa, Yunanistan, İspanya, İsveç, ABD ve Rusya seçilebilir.

Tuş: **Customized entry  
(Kullanıcı girişi)**

**Off (Kapalı):** Ekranında kullanıcı kontrolündeki değişkenin sorgusu görünmez. Bu durumda kayıtlı varsayılan değer yazdırılır.  
**On (Açık):** Kullanıcı kontrolündeki değişkenlerin sorgusu, baskı başlatılmadan önce ekranda bir kez görünür.  
**Auto (Otomatik):** Kullanıcı kontrolündeki değişkenin ve adet sayısının sorgusu, her görünümünden sonra belirir.  
**Auto without quantity query (Adet sayısı sorgusu olmadan otomatik):** Kullanıcı kontrolündeki değişkenin sorgusu, her görünümünden sonra, ilave adet sayısı sorgusu olmadan belirir.



Tuş: **Hotstart  
(Sıcak başlatma)**

**On (Açık):** Durdurulmuş bir yazdırma işine, yazıcı tekrar çalıştırıldıktan sonra tekrar devam edebilirsiniz.  
**Off (Kapalı):** Yazıcı kapandıktan sonra tüm veriler kaybolur.

Tuş: **Autoload  
(Otomatik yükleme)**

**On (Açık):** Compact Flash Kartından bir kez yüklenen bir etiket, yazıcı yeniden başlatıldıktan sonra otomatik olarak tekrar yüklenebilir.  
Yazıcı yeniden başlatıldıktan sonra her zaman Compact Flash Kartı tarafından son yüklenen etiket yeniden yüklenir.  
**Off (Kapalı):** Yazıcı yeniden başlatıldıktan sonra son kullanılan etiketin Compact Flash Kartından manuel olarak tekrar yüklenmesi gerekir.  
Otomatik yükleme ile sıcak başlatma işlevlerini birlikte kullanmak mümkün değildir.

Tuş: **Manual reprint  
(Manüel tekrar yazdırma)**

**Yes (Evet):** Yazıcı, örneğin bir hata oluştuğundan dolayı durdurulmuş modda olduğunda,  ve  tuşları yardımıyla son yazdırılan etiketi yeniden yazdırabilirsiniz.  
**No (Hayır):** Sadece boş etiketler ileri sürülür.

Tuş: **Backfeed/Delay  
(Geri çekme / gecikme)**



**Backfeed (Geri çekme):** Verici (isteğe bağlı) ve ölçer (isteğe bağlı) işletme türlerindeki geri çekilme optimize edilmiş olup, sapmaya gidildiğinde bir sonraki etiket mümkün olduğunda hazır 'basılı' hale getirilir ve dolayısıyla geri çekilmeye etikete gerek duyulmaz ve bu sayede zamandan tasarruf edilebilir.  
**Delay (Gecikme):** Ayarlanan gecikme süresinin sadece *Otomatik geri çekme* işletim türü için bir anlamı vardır.

Tuş: **Label confirmation  
(Düzen onayı)**

**On (Açık):** Yeni bir baskı işi ancak cihazda onaylandıktan sonra yazdırılır.  
Zaten aktif olarak süren bir baskı işi, cihazdan onaylanana kadar basılmaya devam eder.  
**Off (Kapalı):** Kumandanın ekranında hiçbir sorgu görünmez.

Tuş: **Standard label  
(Standart etiket)**

**On (Açık):** Önce bir etiket tanımlanmadan bir baskı işi başlatıldığında, standart etiket (cihaz tipi, ürün yazılımı sürümü, yapı sürümü) basılır.  
**Off (Kapalı):** Önce bir etiket tanımlanmadan bir baskı işi başlatıldığında, ekranda bir hata mesajı görünür.

Tuş: **Synchronization at switching on (Açılıştaki senkronizasyon)****Off (Kapalı):** Senkronizasyon aktif değildir, bu demektir ki ölçüm işlemi ve etiket ilerletmesi elden devreye alınacaktır.**Measure (Ölçme):** Baskı modülünün açılmasından sonra yerleştirilen etiket derhal ölçülür.  
**Label feed (Etiket besleme):** Yazıcı açıldıktan sonra etiket etiketin başlangıcına göre senkronize edilir. Bu amaçla bir ya da birden fazla etiket ileri sürülür.Tuş: **CMI length (CMI Uzunluğu)**

Etiketdeki basıma ara verilirse, baskı başında Etiketle ince beyaz bir çizginin görüleceği basılı görüntüde kısa bir kesinti meydana gelebilir. Bunu önlemek üzere minimum geri çekilme için Etiket malzemesinin geri çekileceği oranda bir değer ayarlanabilir (0–1 mm). Bir sonraki baskı başladığında serbest alanın üzerine basılır. CMI nin uzunluk ayarı sadece optimize edilmiş geri çekilmeyle ilgili geri çekilme modunun seçimine etkili olur.

**Network (Ağ)**Tuş sırası:     

Bu menü seçeneği hakkında daha ayrıntılı bilgiler için lütfen ayrı el kitabına bakın.

**Password (Şifre)**Tuş sırası:      **Operation (Çalıştırma)****Password (Şifre)**

4-haneli numerik bir şifrenin girişi.

Tuş: **Protection configuration (Fonksiyon menüsü - Şifre koruması)**

Yazıcı ayarları değiştirilebilirler (Yakma gücü, Hız, Çalışma şekli, ...). Şifre koruma yazıcı ayarlarındaki değişiklikleri önler.

Tuş: **Protection favorites (Favoriler şifre koruması)**

Şifre koruması, favori menüsüne erişimi engeller.

Tuş: **Protection memory card (Hafıza kartı - Şifre koruması)**

Etiketler hafıza kartı fonksiyonlarıyla depolanıp, yüklenebilir, ...edilebilirler. Şifre koruması hafıza kartları erişimine izin verilip, verilmediğini ya da sadece okuyucu hafıza kartı erişimlerine mi izin verildiğini ayırt etmelidir.

**Tam erişim:** Şifre koruması yok  
**Sadece okuma :** Sadece okuyucu erişimler mümkün  
**Koruma altında:** Erişimler blokeTuş: **Protection printing (Baskı şifre koruması)**

Yazıcı bir PC ye bağlıysa, operatörün manüel olarak bir baskıyı harekete geçirememesi faydalı olabilir. Şifre koruma bir baskının manüel olarak harekete geçirilmesini engeller.

**Network (Şebeke)****Password (Şifre)**

15 haneli bir şifrenin girişi. Giriş alfa numerik ve özel karakterlerden oluşabilir.

Tuş: **Protection HTTP (HTTP Şifre koruması)**

HTTP üzerinden iletişim engellenebilir.

Tuş: **Protection Telnet (Telnet şifre koruması)**









Telnet hizmetinin ayarları değiştirilemez.

Tuş: **Protection remote access  
(Uzaktan erişim Şifre  
koruması)**

Harici bir HMI Arayüz üzerinden erişim engellenebilir.

**DUYURU!**

Engellenmiş bir fonksiyonu uygulamak için, önce geçerli şifrenin girilmesi gerekir. Doğru şifre girildiyse, arzu edilen fonksiyon uygulanır.

**Interface (Arabirimler)**Tuş sırası: , , , , , , , **COM1 / Baud / P / D / S****COM1:**

0 - seri arabirim kapalı

1 - seri arabirim açık

2 - seri arabirim açık; bir aktarma hatasında hiçbir hata mesajı verilmez

**Baud rate (Baud):**

Saniyede aktarılan bitlerin sayısı.

Aşağıdaki değerleri seçebilirsiniz: 2400, 4800, 9600, 19200, 38400, 57600 ve 115200.

**P = Parity (Parite):**

N - Parite yok; E - Çift; O - Tek

Ayarların yazıcınıninkilerle eşit olmasına dikkat edin.

**D = Data bits (Veri bitleri):**







Veri bitlerini ayarlama (7 veya 8 bit seçeneği).

**S = Stop bit (Durma bitleri):**

1 veya 2 durma biti seçme hakkınız vardır. Baytların arasındaki durma bitleri sayısı.

Tuş: **Start/stop sign  
(Başlama/durma işareti)****SOH:** Veri aktarma bloğu başlangıcı → HEX biçimi 01**ETB:** Veri aktarma bloğu sonu → HEX biçimi 17Tuş: **Data memory  
(Veri belleği)****Standard (Standart):** Bir yazdırma işi başlatıldıktan sonra, yazıcının ara belleği dolana kadar veri alınır.**Advanced (Geliştirilmiş):** Bir yazdırma işi devam ederken veri alınmaya ve işlenmeye devam eder.**Off (Kapalı):** Bir yazdırma işi başlatıldıktan sonra başka veri alınmaz.Tuş: **Port test  
(Port testi)**

Verilerin arayüz üzerinden aktarılıp aktarılmadığının denetlenmesi.

Genel olarak (On) seçmek için  ve  tuşlarına basın.  Tuşuna basarsanız, herhangi bir port üzerinden gönderilen veriler (COM1, LPT, USB, TCP/IP), yazdırılır.**Emulation (Emülasyon)**Tuş sırası: , , , , , , , **Protocol  
(Protokol)****CVPL:** Carl Valentin Programlama Dili**ZPL:** Zebra® Programlama Dili ve  tuşlarını kullanarak protokolü seçin. Seçimi onaylamak için  düğmesine basın. Yazıcı yeniden başlatılır ve ZPL II® komutları dahili olarak CVPL komutlarına dönüştürülür.Tuş: **Printhead resolution  
(Baskı başı çözünürlüğü)**

ZPL II® emülasyonu devrede olduğunda, emüle edilen yazıcının baskı başının ayarlanması gerekir.

**DUYURU!**

Zebra® doğrudan baskı sisteminin baskı başı çözünürlüğü Valentin cihazınıninkinden farklıysa, nesnelerin (örneğin metinler, grafikler) büyüklüğü birbirine tam eşit değildir.

Tuş: **Drive mapping  
(Sürücü ataması)**





Zebra® sürücülerine erişim, uygun Valentin sürücülerine aktarılır.

**DUYURU!**

Zebra® doğrudan baskı sisteminde bulunan baskı sisteminin dahili yazı tipleri Valentin cihazlarında bulunmadığından, yazılarda ufak farklar olabilir.

Tuş: **PJL – Printer Job  
Language  
(PJL – Yazıcı Çalışma  
Dilleri)**

Baskıyla ilgili durum bilgileri gösterilebilmektedir.

**Date & Time (Tarih ve saat)**Tuş sırası: **F**, , , , , , , , , **Set date/time  
(Tarih ve saati değiştirme)**Ekranın üst satırı, geçerli tarihi, alt satırı ise geçerli saati gösterir.  ve  tuşları yardımıyla bir sonraki alana geçip, gösterilen değerleri  ve  tuşları yardımıyla artırabilir veya azaltabilirsiniz.Tuş: **Summertime  
(Yaz saati)****On (Açık):** Yazıcı otomatik olarak yaz veya kış saatine geçer.  
**Off (Kapalı):** Yaz saati otomatik olarak algılanıp değiştirilmez.Tuş: **Format – start of  
summertime  
(Yaz saati başlangıcı  
biçimi)**Yaz saati başlangıcını girme biçimini seçin.  
DD = Gün  
WW = Hafta  
WD = Haftanın günü  
MM = Ay  
YY = Yıl  
next day = ancak bir sonraki gün dikkate alınırTuş: **Date – start of  
summertime  
(Yaz saati başlangıç tarihi)**

Yaz saatinin başlamasını istediğiniz tarihi girin. Bu giriş, daha önce seçmiş olduğunuz biçimle ilgilidir.

Tuş: **Time – start of  
summertime  
(Yaz saatinin başladığı  
saat)**

Bu işlev yardımıyla yaz saatinin başlamasını istediğiniz saati girebilirsiniz.

Tuş: **Format – end of  
summertime  
(Yaz saati bitişi biçimi)**

Yaz saati bitişini girme biçimini seçin.

Tuş: **Date – end of summertime  
(Yaz saati bitiş tarihi)**

Yaz saatinin bitmesini istediğiniz tarihi girin. Bu giriş, daha önce seçmiş olduğunuz biçimle ilgilidir.

Tuş: **Time – end of summertime  
(Yaz saatinin bittiği saat)**

Yaz saatinin bitmesini istediğiniz saati girin.

Tuş: **Time shifting  
(Saat kayması)**

Yaz/kış saatini değiştirmede saat ve dakika cinsinden saat kaymasını girin.

## Service Functions (Servis işlevleri)



### DUYURU!

Satıcı veya yazıcı üreticisinin servis durumunda hızlı bir destek sunabilmesi için yazıcının Servis işlevleri menüsü vardır. Örneğin ayarlanmış parametreler gibi gerekli bilgileri doğrudan yazıcıdan da okuyabilirsiniz. Örneğin ürün yazılımı veya yazı tipi sürümü gibi diğer bilgiler için ana menüye bakabilirsiniz.

Tuş sırası: **F**, , , , , , , , , , 

#### Label parameters (Etiket parametresi)

Etiket parametresinin Volt cinsinden değeri.

**A:** Aşgari değer gösterilir.

**B:** Azami değer gösterilir.

**C:** Şalter eşiğinin değeri gösterilir. Ölçme sırasında tespit edilir ve değiştirilebilir.

Tuş: 

#### Photocell configuration (Fotosel ayarları)

Bu işlev, fotosel seviyelerini ayarlamayı sağlar.

Etiketi yerleştirme veya ölçme sırasında herhangi bir sorun çıktığında, etiket fotoselinin seviyelerini manuel olarak da ayarlayabilirsiniz. Olabildiğince büyük bir strokun (etiket için en az 3 V, aralık için en fazla 1 V) ayarlanmasına dikkat edin.

Tuş: 

#### Photocell parameters (Fotosel parametresi)

**DLS:** Altan aydınlatma fotoseli seviyesinin Volt cinsinden değeri.

**TLS:** Yansıtma fotoseli seviyesinin Volt cinsinden değeri.

**SLS:** Optimizasyon fotoseli seviyesinin Volt cinsinden değeri.

**RC:** Aktarma şeridi fotoseli durumunun değeri (0 veya 1).

**H:** Baskı başının konumu için belirtilen 0 veya 1 değeri.

0 = Baskı başı altta

1 = Baskı başı üstte

Tuş: 

#### Paper counter (Çalışma kapasitesi)

**D:** Baskı başı gücünün metre cinsinden değeri.

**G:** Cihaz gücünün metre cinsinden değeri.

Tuş: 

#### Heater resistance (Nokta direnci)

İyi bir baskı resmi elde etmek için baskı başı değişikliği durumunda baskı başında belirtilen Ohm değerinin ayarlanması gerekir.

Tuş: 

#### Printhead temperature (Baskı başı sıcaklığı)

Baskı başı sıcaklığının değeri. Normalde baskı başının sıcaklığı, oda sıcaklığıdır. Ancak maksimum baskı başı sıcaklığı aşıldığında, devam eden baskı işi kesilir ve yazıcı ekranında bir hata mesajı gösterilir.

Tuş: 

#### Motor Ramp (Motor Rampası)

'++' değeri ne kadar yüksek ayarlanırsa, ileri itme motoru da o kadar yavaş hızlanır.

'--' değeri ne kadar düşük ayarlanmışsa, ilerletme motoru da o kadar hızlı frenlenir.

Tuş: 

#### Print examples (Yazdırma örnekleri)

Bu menü seçeneğini çalıştırdığınızda tüm cihaz ayarlarının bir çıktısını alabilirsiniz.

**Settings (Durum raporu):**

Örneğin hız, etiket, aktarma bandı malzemesi vs. gibi tüm cihaz ayarları yazdırılır.

**Bar codes (Barkodlar):**

Kullanılabilir tüm Barkodlar yazdırılır.

**Fonts (Yazı Tipleri):**

Tüm Vektörler ve Bit Eşlem Yazı Tipleri yazdırılır.

Tuş: 

#### Input (Giriş)

Giriş sinyal seviyesinin gösterilmesi.

0 = düşük

1 = yüksek

Tuş: 

#### Output (Çıkış)

Çıkış sinyal seviyesinin gösterilmesi.

0 = düşük

1 = yüksek

Tuş: **I/O status  
(I/O durumu)**

İlgili olaylar sayılır ve RAM belleğine kaydedilir. Yapılan kayıt, cihaz kapatıldıktan sonra silinir.

**RInt** = Real Interrupts

Başlangıç giriş sinyallerini doğrudan kesilmede sayar.

**Dbnc** = Debounced

Ayarlanan yansıma süresinden büyük olan başlangıç giriş sinyallerini sayar. Sadece bu başlangıç sinyalleri bir baskıya neden olabilir. Bir başlangıç sinyali kısaysa baskıya neden olmaz. Bu durum RInt'in saymasından ve Dbnc'nin saymamasından anlaşılabilir.

**NPrn** = Not Printed

Bir baskıya neden olmayan ve yansıyan başlangıç giriş sinyallerini sayar. Bunun nedenleri: aktif baskı görevi yok, baskı görevi durduruldu (manuel ya da bir hatadan dolayı) veya baskı sistemi başka bir baskı görevini işleme aldığı için halen aktif durumdadır.

**PrtStrtReset** = Tüm sayaçları sıfırlar.**PrtStrtTime** = Son başlangıç sinyalinin ölçülen uzunluğu, ms cinsinden.Tuş: **Cutter photocell  
(Bıçak fotoseli)**



1 = Bu yazıcı bir bıçakla donatılmıştır.

0 = Bu yazıcı bir bıçakla donatılmamıştır.



**CH - Cutter Home  
Kesici Başlangıcı**

1 = Bıçak, başlangıç konumundadır ve bu sayede kesmeye hazırdır.

0 = Bıçak, henüz başlangıç konumunda değildir ve kesme işlemi başlatılmadan önce bu konuma getirilmesi gerekir.

Tuş: **Online/Offline  
(Çevrimiçi/Çevrimdışı)**Bu işlev etkinleştirildiğinde,  tuşuyla Çevrimiçi moduyla Çevrimdışı modu arasında geçiş yapabilirsiniz.

Standart: Kapalı

**Online (Çevrimiçi):** Veriler, arabirimler üzerinden alınabilir. Folyolu klavyenin tuşları sadece  tuşuyla Çevrimdışı moduna geçildiğinde aktiftir.**Offline (Çevrimdışı):** Folyolu klavyenin tuşları tekrar aktiftir, ancak alınan veriler artık işlenmez. Cihaz tekrar Çevrimiçi moda döndüğünde tekrar yeni baskı işleri alınır.Tuş: **Transfer ribbon warning  
(Aktarma şeridi ön uyarısı)****TRB = Transfer ribbon advance warning (Aktarma şeridi ön uyarısı):**

Aktarma şeridi bitmeden önce, bir kumanda çıkışı üzerinden bir sinyal verilir.

**Warning diameter (Uyarı çapı):**

Aktarma şeridinin ön uyarı çapını mm cinsinden ayarlama.

Burada mm cinsinden bir değer girildiğinde, (aktarma şeridi makarasında ölçülen) bu değere ulaşıldığında bir kumanda çıkışı üzerinden bir sinyal verilir.

**Ribbon advance warning mode (Ön ikaz işletim türü):****Warning (İkaz):** Ön ikaz çapı değerine erişildiğinde ilgili I/O Çıkış ayarlanır.**Reduced print speed (Düşük hız):** Basım hızına azaltılacak hız değeri.**Error (Hata):** Baskı sistemi ön ikaz çap değerine erişildiğinde 'Aktarma şeridi çok az' mesajı ile durur.**Reduced print speed (Düşük hız):**

Düşük basım hızının mm/s olarak ayarlanması. Bu değer normal basım hızı sınırları aralığında ayarlanabilir.

Tuş: **Zero point adjustment  
in Y direction  
(Y yönüne doğru sıfır  
noktası kaydırması)**

Değer, 1/100 mm olarak girilir.

Baskı başı değiştirildikten sonra basım işlemi etiketteki aynı yerden devam etmediği takdirde bu fark basım yönünde düzeltilebilir.

**DUYURU!**

Eşitleme sıfır noktasının değeri, fabrikada ayarlanır ve ancak baskı başı değiştirilirken servis personeli tarafından yeniden ayarlanabilir.

Tuş: **Zero point adjustment  
in X direction  
(X yönüne doğru sıfır  
noktası kaydırması)**

Değer, 1/100 mm olarak girilir.

Baskı başı değiştirildikten sonra basım işlemi etiketteki aynı yerden devam etmediği takdirde bu fark basım yönünün enine doğru düzeltilebilir.

**DUYURU!**

Eşitleme sıfır noktasının değeri, fabrikada ayarlanır ve ancak baskı başı değiştirilirken servis personeli tarafından yeniden ayarlanabilir.

Tuş: 

**Print length**  
(Baskı uzunluğu +/-)

Baskı görüntüsü düzeltilmesinin yüzde olarak ayarı.  
Mekanik etkilere (örn. rulo boyutu) nedeniyle baskı görüntüsü, orijinal boyutuna oranla hem büyütülebilir hem de küçültülebilir.  
Değerler alanı: +10.0 % ... -10.0 % arası

Tuş: 

**Write log files on MC**  
(Log Dosyalarının MC ye yazılması)

LOG Dosyaları bu komutla mevcut bir veri saklama aygıtına (MC-Kartı) yazılır. 'Hazır' ihbarından sonra veri saklama aygıtı çıkartılabilir.

Dosyalar 'log' dizininde bulunmakadır.

**LogMemErr.txt:** Kayda geçirilmiş örneğin Tarih/Saat ve Dosya adı/sıra numarası gibi ek bilgili hatalar (Geliştiriciler için)

**LogMemStd.txt:** Seçilmiş olayların kaydı

**LogMemNet.txt:** En son Port 9100 dan gönderilen veriler

**Parameters.log:** İnsan tarafından okunabilecek şekildeki tüm baskı parametreleri

**TaskStatus.txt:** Yazıcının tüm görev durumları

## Main Menu (Ana menü)

Etiket yazıcısı çalıştırdıktan sonra ana menü gösterilir. Ana menü, örneğin yazıcı tipi, geçerli tarih ve geçerli saat, ürün yazılımının ve kullanılan FPGA'ların sürüm numarası gibi bilgileri gösterir.

Seçilen gösterge sadece kısa bir süre gösterilir, sonra tekrar ilk bilgiye geçilir.

 düğmesiyle bir sonraki göstergeye geçilebilir.

## Compact Flash kartı / USB bellek çubuğu\*

Yazıcının folyolu klavye tuşlarıyla veya takılan bir USB klavyenin çeşitli işlev tuşlarıyla bellek menüsü kullanılır.

		Son menüye dön.
		Load layout (düzen yükle) işlevinde: Dosya gezginine geçiş Dosya Gezgini: Bağlam menüsüne geçiş (context menu).
		Birden fazla seçim yapılabildiğinde, bir dosyayı/dizini işaretleme.
		Ana menü: Bellek menüsünü seçme. Dosya Gezgini: Yeni bir dosya oluşturma.
		Geçerli dosya/geçerli dizin için geçerli işlevi gerçekleştirme.
		Üst dizine geçiş.
		Geçerli işaretli dizine geçiş.
		Geçerli dizinde yukarı kaydırma.
		Geçerli dizinde aşağı kaydırma.

### Define user directory (Kullanıcı dizinini belirle)

İşlenecek olan dosyaların kaydedildiği standart dizini belirler.



#### DUYURU!

Aşağıdaki durumlarda bir kullanıcı dizininin belirlenmesi zorunludur:

- Bellek Menü kullanılmadan veya navigasyonu öncesinde.
- Bilgisayarda CF kartının formatlanması gerçekleştirildiğinde ve böylece STANDART dizin otomatik olarak oluşturulmadığında.

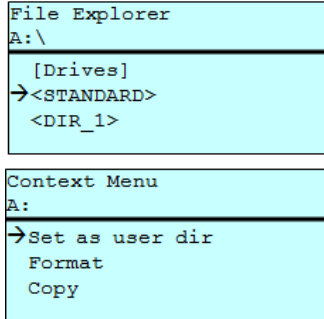

Bellek menüsüne erişim.



Dosya Gezgini açın.

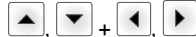

Dizini seçin.



Kullanılabilir fonksiyonların gösterilmesi



Set as user dir (kullanıcı dizini olarak) işlevini seçin



Seçimi onaylayın.



Ana menüye geri dön.

Bellek menüsünün bir sonraki açılmasında seçilmiş olan dizin, kullanıcı dizini olarak gösterilir.

### Load layout (Düzeni yükleyin)

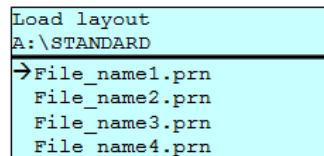

Belirlenmiş olan kullanıcı dizisi içindeki Layout'u yükle. Bu fonksiyon istenilen Layout'a hızlı bir şekilde erişmeyi mümkün kılar zira burada sadece Layout dosyaları görüntülenir ve dizinler kapatılarak gösterilmez.



Bellek menüsüne erişim.



Layout seç.



Seçimi onaylayın.

Adet giriş penceresi otomatik olarak gösterilir.



Yazdırılmasını istediğiniz düzen sayısını seçin.



Baskı işini başlatın.



#### DUYURU!

Dizin burada DEĞİŞTİRİLEMEZ. Bir dizin değiştirmenin Dosya Gezgini'nde *Change directory* (Dizin değiştir) işleviyle yapılması ŞARTTIR.

\* mevcut değil



**Dosya Gezginini**

Dosya gezginini yazdırma sisteminin dosya yönetim sistemidir. Bellek menüsü ana fonksiyonları dosya gezgininde kullanıma sunulur.

Dosya gezginine erişmek için kullanıcı dizini görünümünde **F** butonuna basın.

Burada aşağıdaki fonksiyonlar seçilebilir:





- Sürücü veya dizin değiştirme
- Dosya yükle
- Layout veya konfigürasyon kaydet
- Dosya (dosyaları) sil
- CF Kartını formatla
- Dosya (dosyaları) kopyala

**Change directory  
(Dizin değiştir)**

```
File Explorer
A:\
[Drives]
-><STANDARD>
<DIR_1>
```

```
File Explorer
A:\STANDARD\
-><..>
layout01
layout02
```





Dosyaların kaydedildiği sürücü veya dizini seçme.

-  Bellek menüsüne erişim.
-  Dosya Gezginini açın.
-  Dizini seçin.
-  Seçimi onaylayın.
-  Seçilmiş olan dizin gösterilir.

**Load file  
(Dosyayı yükle)**

```
Load file
A:\STANDARD\
<..>
->layout01
layout02
```

Herhangi bir dosyayı yükler. Bu, daha önce kaydedilmiş bir yapılandırma, düzen vs. olabilir.

-  Bellek menüsüne erişim.
-  Dosya Gezginini açın.
-  Dosyayı seçin.
-  Seçilen dosya yüklenir.





**DUYURU!**

Seçilen dosyada bir Düzen söz konusu ise, yazdırılacak kopya sayısı hemen girilebilir.

**Save layout  
(Düzeni kaydet)**

```
Save file
A:\STANDARD
->Save layout
Save config.
noname
```

Güncel olarak yüklenmiş olan düzeni seçilen ad altında kaydeder.





-  Bellek menüsüne erişim.
-  Dosya Gezginini açın.
-  *Save file* (Dosyayı kaydet) menüsüne geçer.
-  *Save layout* (Düzeni kaydet) işlevini seçin.
-  Seçimi onaylayın.

Bir USB klavye takılı ise, *noname* (isimsiz) için yeni bir dosya adı verilebilir.

### Save configuration (Yapılandırmayı kaydet)

```
Save file
A:\STANDARD
Save layout
→ Save config.
config.cfg
```

Komple, güncel yazıcı yapılandırmasını seçilen ad altında kaydeder.







-  Bellek menüsüne erişim.
- F** Dosya Gezgini açın.
-  *Save file* (Dosyayı kaydet) menüsüne geçin.
-  ,  *Save configuraton (Yapılandırmayı kaydet)* işlevini seçin.
-  Seçimi onaylayın.

Bir USB klavye takılı ise, *config.cfg* için yeni bir dosya adı verilebilir.

### Delete file (Dosyaları sil)

```
File Explorer
A:\STANDARD\
layout01 *
→ layout02 *
layout03
layout04
Context menu
2 objects marked
→ Delete
Copying
```

Bir veya birden fazla dosya veya dizini geri alınamayacak şekilde siler. Bir dizini silerken, içerdiği dosyalar ve alt dizinler de birlikte silinir.

-  Bellek menüsüne erişim.
- F** Dosya Gezgini açın.
-  +  Dosyayı seçin.
-  Silinecek olan dosyaları işaretleyin. İşaretli girişler, \* ile gösterilir. Silmek istediğiniz tüm dosya veya dizinler işaretlenene kadar bu işleme devam edin.
- F** Bağlam menüsüne geçiş.
-  +  *Delete* (Sil) işlevini seçin.
-  Seçimi onaylayın.

### Formatting (Biçimlendir)









Bir bellek kartını geri alınamayacak şekilde biçimlendirir.



#### DUYURU!

USB bellekleri doğrudan baskı sisteminden biçimlendirilemez!

```
File Explorer
DRIVES
→ A: 954Mb free
U: No media
Context menu
A:\
Set as user dir
→ Formatting
Copy
```

-  Bellek menüsüne erişim.
- F** Dosya Gezgini açın.
-  ,  +  ,  Biçimlendirmek istediğiniz sürücüyü seçin.
- F** Bağlam menüsüne geçiş (context menu).
-  +  *Formatting* (Biçimlendir) işlevini seçin.
-  Seçimi onaylayın.

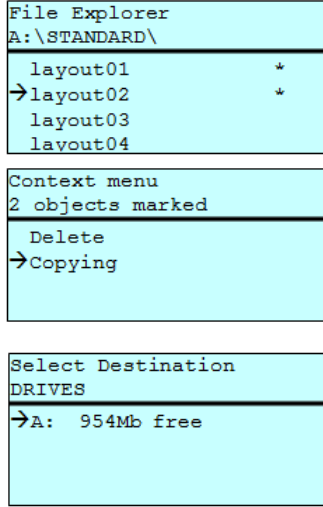
**Copying  
(Kopyala)**

Daha sonra orijinalden bağımsız olarak değişiklikler yapabilmek için, asıl dosyanın veya asıl dizinin bir kopyasını oluşturur.



Bellek menüsüne erişim.



Dosya Gezinimini açın.

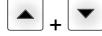

Dosyayı seçin.



Kopyalanacak olan dosyaları işaretleyin. İşaretili girişler, \* ile gösterilir. Kopyalamak istediğiniz tüm dosya veya dizinler işaretlenene kadar bu işleme devam edin.



Bağlam menüsüne geçiş (context menu).

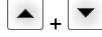

Copying (Kopyala) işlevini seçin.



Kopyalama işleminin hedefini belirleyin.

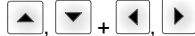

Hedef kayıt yerini seçin.



Seçimi onaylayın.

**Filtre:****Sadece bir USB klavye ile bağlantılı olarak mümkündür.**

Bir USB klavye takılıysa, belli işlevlerde bir filtre maskesi veya kaydedilecek olan dosyanın dosya adı belirtilebilir. Bu giriş, bir yol satırında gösterilir. Filtre maskesiyle belli dosyalar aranabilir. Örneğin "L" girildiğinde sadece "L" dizesiyle başlayan dosyalar gösterilir. (Büyük/küçük harfler dikkate alınmaz).

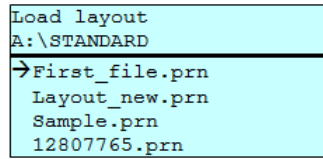
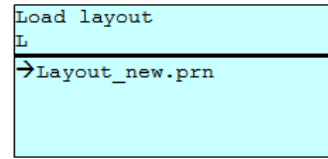
**Filtresiz****Filtreli**

**Teknik veriler**

	Vita II 103/8 T	Vita II 104/8	Vita II 106/12	Vita II 106/24	Vita II 108/12 T
Çözünme	203 dpi	203 dpi	300 dpi	600 dpi	300 dpi
Maks. Baskı hızı	200 mm/s	200 mm/s	150 mm/s	100 mm/s	150 mm/s
Baskı genişliği	104 mm	104 mm	105,7 mm	105,7 mm	108,4 mm/s
Geçiş genişliği					
Standard Bıçak/besleme modu	116 mm 112 mm	116 mm 112 mm	116 mm 112 mm	116 mm 112 mm	116 mm 112 mm
Baskı başı	Düz Tip <sup>1</sup>	Düz Tip <sup>2</sup>	Düz Tip <sup>2</sup>	Düz Tip <sup>2</sup>	Düz Tip <sup>1</sup>
<b>Etiketler</b>					
Merdanede veya Lepo merdanesindeki etiket veya yazıcı malzemesi	Kağıt, karton, tekstil, plastik				
Malzeme kalınlığı	maks. 220 gr/m <sup>2</sup> (istek üzerine daha büyük)				
Min. etiket genişliği	12 mm				
Min. etiket yüksekliği					
Standard Bıçak/besleme modu	5 mm 15 mm				
Maks. etiket yüksekliği	6000 mm	6000 mm	3000 mm	1000 mm	3000 mm
Rulo çapı					
Dahili çözme Dahili sarma	180 mm ---				
Çekirdek çapı	40 mm / 75 mm (opsiyon)				
Sargı	dış veya iç				
Etiket sensörü	Alttan aydınlatma ve yansıtma				
<b>Transferband</b>					
Renkli taraf	dış veya iç				
Rulo çapı	Ø 80 mm				
Çekirdek çapı	25,4 mm / 1"				
Maks. uzunluk	450 m				
Maks. genişlik	110 mm				
<b>Ebatlar (mm)</b>					
Genişlik x Yükseklik x Derinlik	236 x 238 x 374				
Ağırlık yaklaşık	11 kg				
<b>Elektronik</b>					
İşlemci	Yüksek Hız 32 Bit				
Bellek (RAM)	16 MB				
Yuva	Compact Flash kart tipi I için				
Pil	Gerçek zamanlı saat için (elektrik kesildiğinde veri kaydı)				
Uyarı sinyali	Hatada sesli sinyal				
<b>Arabirimler</b>					
Seri	RS-232C (ila 115200 Baud)				
Paralel	SPP				
USB	2.0 Yüksek Hızlı Slave				
Ethernet	10/100 Base T, LPD, RawIP Baskı, DHCP, HTTP, FTP				
WLAN (opsiyon)	Modül 802.11 b/g/n WEP, WPA, WPA-PSK, WPA2, WPA2-PSK, EAP				

<sup>1</sup> = Isı direkt<sup>2</sup> = Isı transferi

Bağlantı değerleri	Vita II 103/8 T	Vita II 104/8	Vita II 106/12	Vita II 106/24	Vita II 108/12 T
Besleme voltajı standart	110 ... 230 V AC / 50-60 Hz				
Güç girişi	275 VA				
Elektrik	2,5 A				
Sıcaklık	5 ... 35 °C				
Nispi nem	maks. 80 % (yoğuşmaz)				
<b>Kumanda alanı</b>					
Tuşlar	Test baskı, fonksiyon menüsü, parça adedi, CF kartı, Besleme, Enter, 4 x imleç				
LCD göstergesi	Grafik ekran 132 x 64 piksel				
<b>Ayarlar</b>					
	Tarih, saat, vardiya saatleri 20 dil ayarı (istek üzerine başkaları) Etiket, cihaz numarası, arayüzler, parola koruması				
<b>Denetimler</b>					
Baskı durdurması yeri	Aktarma bant sonu / etiket sonu / baskı başı açık				
Durum baskısı	Örneğin çalışma kapasitesi, fotosel, arayüz, şebeke parametreleri gibi cihaz ayarlarının baskısı Dahili yazı tiplerinin ve desteklenen tüm barkodların baskısı				
<b>Yazılar</b>					
Yazı tipleri	6 biteşlem yazı tipleri 8 vektör yazı tipleri/TrueType yazı tipleri 6 orantılı yazı tipleri Diğer yazı tipleri istek üzerine				
Karakter setleri	Windows 1250 ila 1257, DOS 437, 850, 852, 857, UTF-8 Tüm Batı ve Doğu Avrupa, Latin, Kiril, Yunan ve Arap (opsiyon) karakterler destekleniyor. Diğer karakter setleri istek üzerine				
Biteşlem Yazı Tipleri	Genişlik ve yükseklik olarak boyut 0,8 ... 5,6 Büyütme faktörü 2 ... 9 Hizalama 0°, 90°, 180°, 270°				
Vektör yazı tipleri/TrueType yazı tipleri	Genişlik ve yükseklik olarak boyut 1 ... 99 mm Kademesi büyütme faktörü Hizalama 0°, 90°, 180°, 270°				
Yazı öznelikleri	Yazı türüne bağlıdır: Kalın, yatık, ters, dikey				
Karakter aralığı	Değişken				
<b>Barkodlar</b>					
1D barkodlar	CODABAR, Code 128, Code 2/5 interleaved, Code 39, Code 39 extended, Code 93, EAN 13, EAN 8, EAN ADD ON, GS1-128, Identcode, ITF 14, Leitcode, Pharmacode, PZN 7 Code, PZN 8 Code, UPC-A, UPC-E				
2D barkodlar	Aztec Code, CODABLOCK F, DataMatrix, GS1 DataMatrix, MAXICODE, PDF 417, QR Code				
Kompozit barkodlar	GS1 DataBar Expanded, GS1 DataBar Limited, GS1 DataBar Omnidirectional, GS1 DataBar Stacked, GS1 DataBar Stacked Omnidirectional, GS1 DataBar Truncated				
	Tüm barkodların yüksekliği, modül genişliği ve oranı değişkendir Hizalama 0°, 90°, 180°, 270° İsteğe bağlı olarak kontrol rakamı ve net yazı baskısı				
<b>Yazılım</b>					
Konfigürasyon	ConfigTool				
İşlem kumandası	NiceLabel				
Etiket yazılımı	Labelstar Office Lite Labelstar Office				
Windows sürücüsü	Windows 7® - Windows 10® 32/64 Bit Windows Server 2008® (R2) - Windows Server 2019®				

Teknik değişiklik hakkı saklıdır.

## Temizleme



### TEHLİKE!

Elektrik çarpması nedeniyle hayati tehlike!

⇒ Tüm bakım çalışmalarından önce baskı sisteminin fişini çekin ve adaptör boşalana kadar kısaca bekleyin.



### DUYURU!

Cihazın temizlenmesi esnasında, koruma gözlüğü ve eldiven gibi kişisel koruma donanımı kullanılması tavsiye edilir.

Bakım işi	Aralık
Genel Temizlik	Gerekli olduğunda.
Aktarma şeridi-çekme merdanesini temizleyin.	Transfer folyosunu her değiştirme esnasında veya baskı kalitesinin olumsuz etkilenmesi durumunda.
Baskı merdanesinin temizlenmesi.	Etiket rulosunu her değiştirme sırasında veya yazdırma kalitesinin ve etiket naklinin olumsuz etkilenmesi durumunda
Yazdırma kafasının temizlenmesi.	<b>Doğrudan termo baskı:</b> Etiket rulosunu her değiştirme esnasında. <b>Termo transfer baskı:</b> Transfer folyosunu her değiştirme esnasında veya baskı kalitesinin olumsuz etkilenmesi durumunda
Etiket ışık bariyerinin temizlenmesi.	Etiket rulusunun yenilenmesi durumunda.



### DUYURU!

Isopropanol (IPA)'nın kullanılmasına ilişkin işleme talimatlarına uyulmalıdır. Deri veya gözleriniz ile temas olursa, bol su ile iyice yıkayın. Eğer tahriş hissi devam ederse doktora başvurun. İyi havalandırma olmasını sağlayın.



### UYARI!

Kolay tutuşan etiket çözücüsünden kaynaklanan yangın tehlikesi vardır!

⇒ Etiket çözücü kullanıldığında etiket baskı makinesinin tozunun alınması ve temizlenmesi gerekir.

## Genel Temizlik



### DİKKAT!

Yazıcı sert temizlik maddeleri nedeniyle zarar görebilir!

⇒ Dış yüzeylerin veya yapı gruplarının temizliği için aşındırıcı malzemeler ya da çözelti maddeleri kullanmayın.

⇒ Baskı alanındaki toz ve kağıt kalıntılarını yumuşak bir fırça veya elektrikli süpürge ile uzaklaştırın.

⇒ Dış yüzeyleri çok amaçlı temizleyicilerle temizleyin.

## Aktarma şeridi-çekme merdanesini temizleyin

Çekme merdanesinin kirlenmesi, kötü bir baskı kalitesine ve malzeme taşımalarının sınırlandırılmasına neden olabilir.

- Yazıcının kapağını açın.
- Etiketleri ve transfer folyosunu yazıcıdan çıkarın.
- Kalıntıları merdane temizleyicisi ve yumuşak bir bez ile temizleyin.
- Merdanede hasar varsa, merdaneyi değiştirin.

## Baskı merdanesinin temizlenmesi

Baskı merdanesinin kirlenmesi, kötü bir baskı kalitesine ve malzeme taşımalarının sınırlandırılmasına neden olabilir.



### DİKKAT!

Baskı silindirin zarar görmesi!

⇒ Baskı silindirin temizlemek için keskin, sivri veya sert cisimler kullanmayın.

- Kolu, yazdırma kafasını kaldırmak için saat yönünün tersi istikametinde çevirin.
- Etiketleri ve transfer folyosunu yazıcıdan çıkarın.
- Kalıntıları merdane temizleyicisi ve yumuşak bir bez ile temizleyin.
- Merdane hasar göstermesi durumunda merdaneyi değiştirin.

## Yazdırma kafasının temizlenmesi

Yazdırma esnasında yazdırma kafasında, baskı kalitesini olumsuz etkileyen kirler birikebilir, örn. kontrast farklılıkları veya dikey şeritler nedeniyle.



### DİKKAT!

Baskı kafasının zarar görmesi!

⇒ Baskı kafasını temizlemek için keskin, sivri veya sert cisimler kullanmayın.

⇒ Yazdırma kafasının cam koruma tabakasına dokunmayın.

- Kolu, yazdırma kafasını kaldırmak için saat yönünün tersi istikametinde çevirin.
- Etiketleri ve transfer folyosunu yazıcıdan çıkarın.
- Yazdırma kafası yüzeyini özel temizleme kalemiyle veya saf alkole bandırlanmış pamuk çubuğu ile temizleyin.
- Yazıcıyı ilk çalıştırma işleminden önce yazdırma kafasının 2–3 süreyle kurumasını bekleyin.

## Etiket ışık bariyerinin temizlenmesi



### DİKKAT!

Işık bariyeri hasar görebilir!

⇒ Işık bariyerini temizlemek için aşındırıcı veya sert çözelti maddeleri kullanmayın.

Etiket ışık bariyeri kağıt tozu nedeniyle kirlenebilir. Bu nedenle etiket ucunu algılama sensörü olumsuz etkilenebilir.

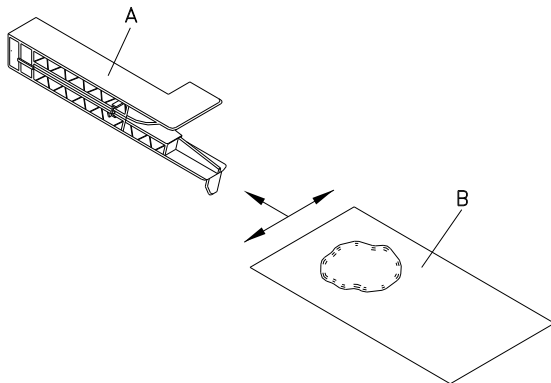

- Kolu, yazdırma kafasını kaldırmak için saat yönünün tersi istikametinde çevirin.
- Etiketleri ve transfer folyosunu yazıcıdan çıkarın.
- Fotosele (A) basınçlı sprey sıkın.  
Kutudaki talimatlara uyun.
- Fotosel şeridi (A) ayrıca daha önce saf alkole nemlendirilmiş bir temizlik kartıyla (B) da temizlenebilir. Temizlik kartı ileri-geri kaydırılmalıdır (bakınız şekil).
- Etiketleri ve transfer folyosunu tekrar yerine takın.



---

Carl Valentin GmbH  
Neckarstraße 78 – 86 u. 94 . 78056 Villingen-Schwenningen  
Phone +49 7720 9712-0 . Fax +49 7720 9712-9901  
info@carl-valentin.de . www.carl-valentin.de